

GRAVELY OPERATOR'S MANUAL

NAME: ROTARY PLOW

PART NUMBER(S): 43902

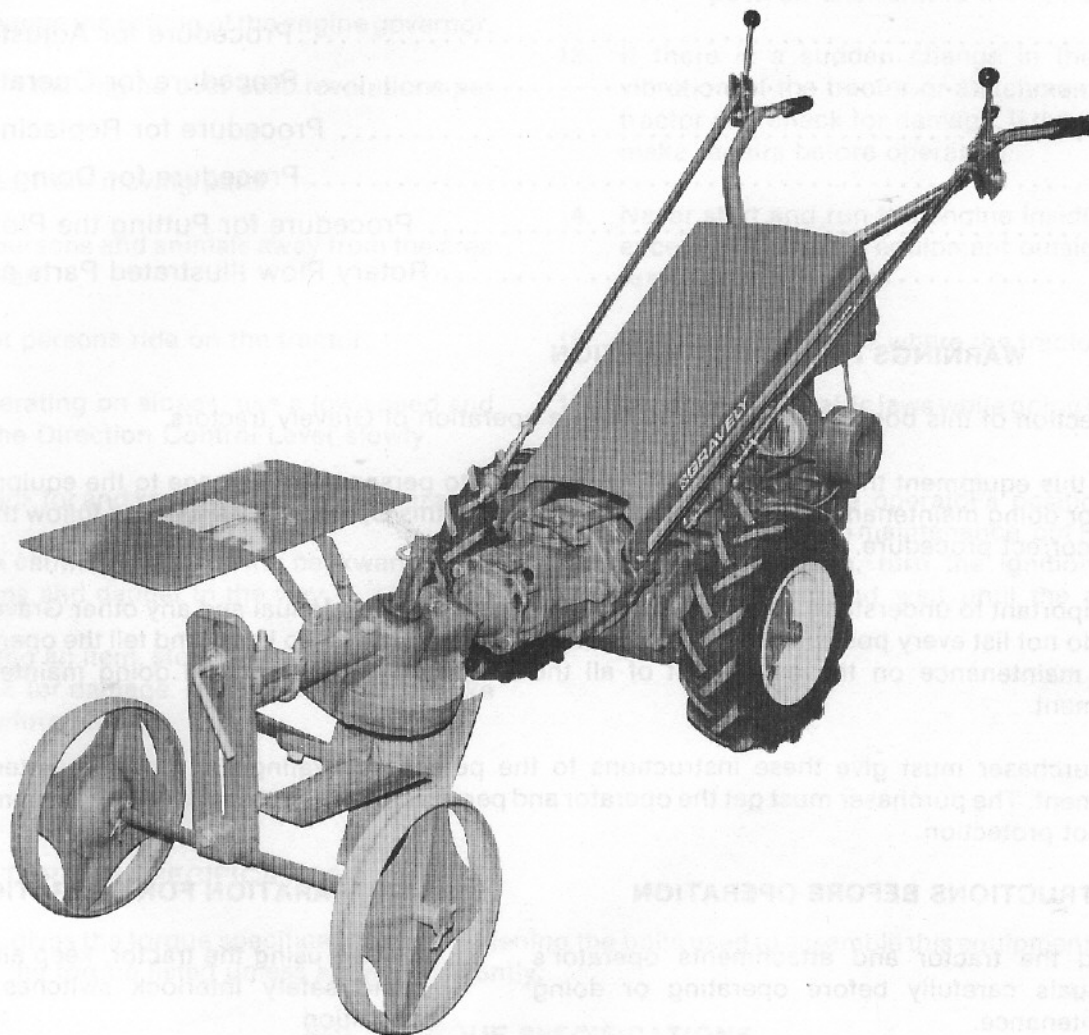

The Rotary Plow is for use with the Gravely two wheel tractors.

All reference to right side, left side, front and rear are given from the operator's position.

To continue its program of quality and design improvement, the manufacturer reserves the right to change specification, designs and prices without notice and incurring obligation.

Form No. 43910(4-87)

Printed in U.S.A.

CONTENTS

1.0	Warnings for Safe Operation
2.0	Bolt Torque Specifications
3.0	Procedure for Connecting the Plow to the Tractor
4.0	Procedure for Removing the Plow From the Tractor
5.0	Procedure for Adjusting the Plow
6.0	Procedure for Operating the Plow
7.0	Procedure for Replacing the Blades
8.0	Procedure for Doing Maintenance
9.0	Procedure for Putting the Plow in Storage
10.0	Rotary Plow Illustrated Parts and Parts List

1.0 WARNINGS FOR SAFE OPERATION

This section of this book gives warnings for safe operation of Gravely tractors.

Using this equipment the wrong way can cause injury to persons and damage to the equipment. Persons using or doing maintenance on this equipment must read this Operator's Manual and follow the instructions using correct procedure.

It is important to understand that the warnings in this Operator's Manual and any other Gravely instruction book do not list every possible danger. It is not possible for Gravely to know and tell the operator or person doing maintenance on the equipment of all the dangers in operating and doing maintenance on the equipment.

The purchaser must give these instructions to the persons operating and doing maintenance on this equipment. The purchaser must get the operator and person doing maintenance on this equipment to use eye and foot protection.

1.1 INSTRUCTIONS BEFORE OPERATION

1. Read the tractor and attachments operator's manuals carefully before operating or doing maintenance.
2. Learn the location and function of all tractor and attachment controls.
3. Know how to use the controls to stop the tractor and attachment in a short time.
4. Never permit children to operate or ride on the tractor.
5. Use Caution with gasoline. Gasoline is very flammable. Keep gasoline in a clean and tight container. Keep gasoline away from flames or hot items. Never put gasoline in the fuel tank while the engine is running or hot. Clean any gasoline leakage before starting the engine.

1.2 PREPARATION FOR OPERATION

1. When using the tractor, keep all shields, guards and safety interlock switches in the correct position.
2. Wear strong shoes and clothing that is not loose when operating the tractor. Make sure your feet and eyes have protection.
3. Before starting the engine, put the Direction Control Lever in neutral and PTO Control in "OFF" position.
4. Do not use the tractor where the work area is too dark for the operator to see.
5. Keep the tractor in good operating condition. Do the maintenance as shown in the tractor Operator's Manual.

- 6. Never operate the tractor or attachment when there is damage to any part or any part is not in the correct position. Replace all parts when damaged or missing before operating.
- 7. USE ONLY GRAVELY ACCESSORIES AND ATTACHMENTS OR EQUIPMENT shown by Gravelly to be correct for use with the tractor.

1.3 PROCEDURE FOR OPERATION

- 1. Do not change the setting of the engine governor.
- 2. Do not run the engine over 3600 revolutions per minute.
- 3. Keep away from moving parts.
- 4. Keep all persons and animals away from the area of operation.
- 5. Do not let persons ride on the tractor.
- 6. When operating on slopes, use a low speed and engage the Direction Control Lever slowly.
- 7. Always look for and keep from holes and hazards.
- 8. Use more caution when moving backward. Look for persons and danger in the way.
- 9. After hitting an item, stop the tractor and engine and check for damage. If there is damage, make repairs before starting.

- 10. Operate equipment only when in the operator's position.
- 11. When moving the equipment on a transport, connect the tractor chassis and tractor rear hitch to the transport. Never connect from control levers, rods or like items, that could be damaged.
- 12. Before leaving the tractor, put the PTO Control in the "OFF" position, turn the Ignition Switch to the "OFF" position and remove the Ignition key.
- 13. If there is a sudden change in the sound or vibration of the tractor or attachments, stop the tractor and check for damage. If there is damage make repairs before operating.
- 14. Never start and run the engine inside a building except to move the equipment outside. Exhaust fumes are dangerous.
- 15. Go slow on surfaces where the tractor can slide.
- 16. Always follow traffic laws while going on or near a road.
- 17. Before leaving the operator's position to make adjustments, or do maintenance, put PTO control in "OFF" position, turn the ignition switch to "OFF" position and wait until the engine and moving parts stop.

2.0 BOLT TORQUE SPECIFICATIONS

This section gives the torque specifications for tightening the bolts used to assemble this equipment. Tighten the bolts to the torque listed unless shown differently.

BOLT SIZE	BOLT TORQUE SPECIFICATIONS	
	FOOT POUNDS (ft. lbs.)	NEWTON METERS (N.m)
1/4"	7	9.5
5/16"	14	19
3/8"	25	34
7/16"	40	54
1/2"	60	82
9/16"	83	113
5/8"	120	163
3/4"	200	271

3.0 PROCEDURE FOR CONNECTING THE PLOW TO THE TRACTOR

This section gives the procedure for connecting the Plow to the tractor.

1. Put the Attachment Dog on the Power Take-off (PTO) Shaft of the tractor as shown in figure 3.0-1.

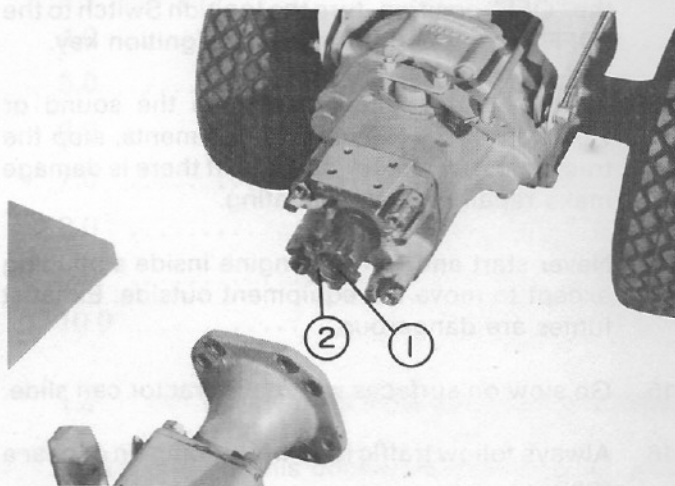

- 1 - PTO Shaft
- 2 - Attachment Dog

Figure 3.0-1

2. Fasten the Plow to the Attachment Adapter with the Attachment Bolts as shown in figure 3.0-2.

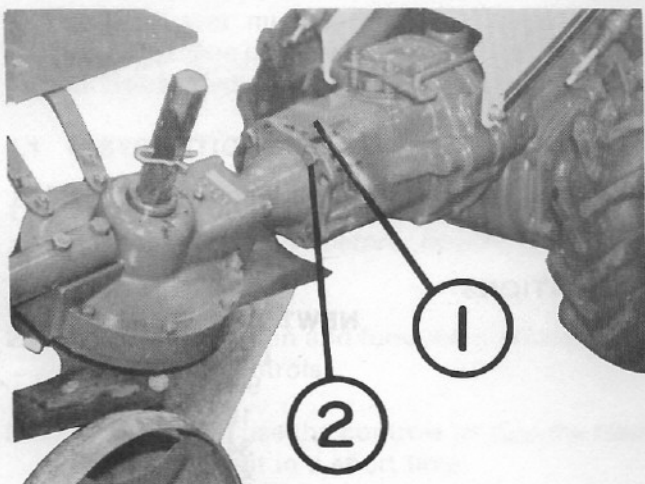

- 1 - Attachment Adapter
- 2 - Attachment Bolts

Figure 3.0-2

4.0 PROCEDURE FOR REMOVING THE PLOW FROM THE TRACTOR

This section gives the procedure for removing the Plow from the tractor.

1. Remove the Attachment Bolts that fasten the Plow to the Attachment Adapter and remove the Plow. See figure 3.0-2.
2. Remove the Attachment Dog from the PTO Shaft. See figure 3.0-1. Keep the Attachment Dog with the Plow.

5.0 PROCEDURE FOR ADJUSTING THE PLOW

This section gives the procedure for adjusting the Plow if needed for your soil conditions. Adjust the Plow for less width of cut when plowing deep or in hard soil.

1. Loosen the Axle Clamp Bolt and move the depth wheel axle until the center of the right side wheel is 9-1/2" (24 cm) from the center of the Wheel Bracket. Tighten the Axle Clamp Bolt. See figure 5.0-1.

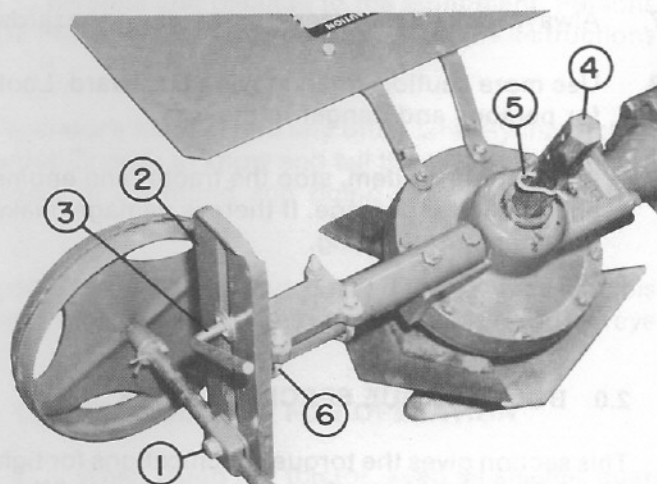

- 1 - Axle Clamp Bolt
- 2 - Wheel Bracket
- 3 - Wheel Bracket Clamp Screw
- 4 - Rotor Axle
- 5 - Depth Adjusting Pin
- 6 - "U" Bolts

Figure 5.0-1

2. Loosen the Wheel Bracket Clamp Screw and move the screw until it is 10-1/2" (27 cm) from the ground. Tighten the Wheel Bracket Clamp Screw.
3. Adjust the "U" Bolts so the depth wheels will swivel and follow the ground.

- Put the Depth Adjusting Pin in the the top hole in the Rotor Axle.

NOTE: Adjust the depth wheel for less width of cut when plowing deep or in hard soil by moving the right side gauge wheel towards the Wheel Bracket.

6.0 PROCEDURE FOR OPERATING THE PLOW

This section gives the procedure for operating the Plow. Read this Operator's Manual and the tractor Operator's Manual before operating. Use a slow speed until you know how to use the Plow.

- Start the tractor engine and wait until the engine is running smoothly before operating.

NOTE: Plow the first furrow through the center of the area to be plowed as shown in figure 6.0-1.

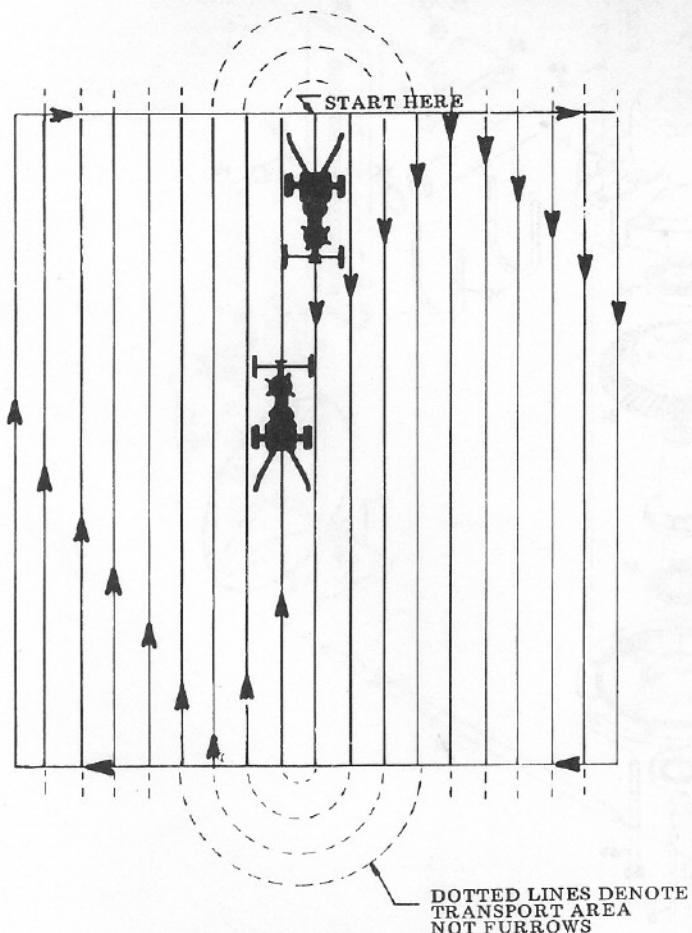

Figure 6.0-1

- Put the RANGE selector in the "LOW" position.
- Put the GEAR selector in the "LOW" position.

- Move the throttle lever to the "FAST" position.
- Move the tractor to where the first furrow is to be plowed.
- Push down on the tractor handlebars and raise the Plow off the ground, engage the PTO and lower the plow to the ground.
- Put the Direction Control Lever in the "forward" position and plow the first furrow.

WARNING: Walk behind the tractor handlebars, not between.

- At the end of the first furrow, stop the tractor, put the PTO in the "OFF" position and turn the ignition switch to the "OFF" position.
- Put the Depth Adjusting Pin in the second hole from the top in the Rotor Axle. (With the right side depth wheel and tractor wheel in the furrow the plow will cut deeper).
- Restart the tractor engine and move the tractor in position to plow the second furrow. Push down on the handlebars to raise the Plow off the ground and engage the PTO.
- Put the right side depth wheel and tractor wheel in the furrow, lower the plow to the ground and plow the second furrow.
- At the end of the second furrow, push down on the tractor handlebars and raise the plow off the ground. Turn the tractor to the right and to the position of the next furrow. Put the right side gauge wheel and tractor wheel in the furrow, lower the Plow to the ground and plow the furrow. Repeat the procedure at the end of each furrow. See figure 6.0-1.

7.0 PROCEDURE FOR REPLACING THE BLADES

This section gives the procedure for replacing the Blades.

- Follow the procedure shown in section 6.0 to separate the plow and tractor.
- Remove the Depth Adjusting Pin from the Rotor Axle shown in figure 4.0-1.
- Remove the Rotor Axle from the Plow Drive.

4. Remove the Square Nuts from the Plow Bolts and remove the Blades. See figure 7.0-1.

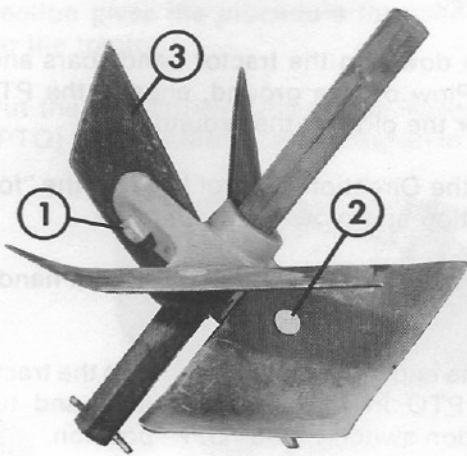

- 1 - Square Nut
- 2 - Plow Bolt
- 3 - Blade

Figure 7.0-1

5. Replace the Blades and reassemble the Plow.

8.0 PROCEDURE FOR DOING MAINTENANCE

This section gives the procedure for doing maintenance after each use.

1. Remove all dirt and debris from the Plow..
2. Inspect all nuts, bolts and other fasteners to make sure they are tight and replace any that are missing.

3. Check the Blades to see if there is damage. If the Blades have damage, replace the Blades as shown in section 7.0.

4. Every 40 hours of operation, clean the grease fitting on top of the drive and add multi-purpose grease until it shows at the shaft.

9.0 PROCEDURE FOR PUTTING THE PLOW IN STORAGE

This section gives the procedure for putting the Plow in storage. When the Plow will not be operated for three months or more, follow this procedure.

1. Do the maintenance shown in section 8.0.
2. To prevent rust, put paint or multi-purpose grease on any area where the paint has been removed.

10.0 ROTARY PLOW ILLUSTRATED PARTS AND PART LIST

This section show the Rotary Plow Illustrated Parts and Parts List. Figure 10.0-1 shows the Illustrated Parts. Figure 10.0-2 shows the Parts List.

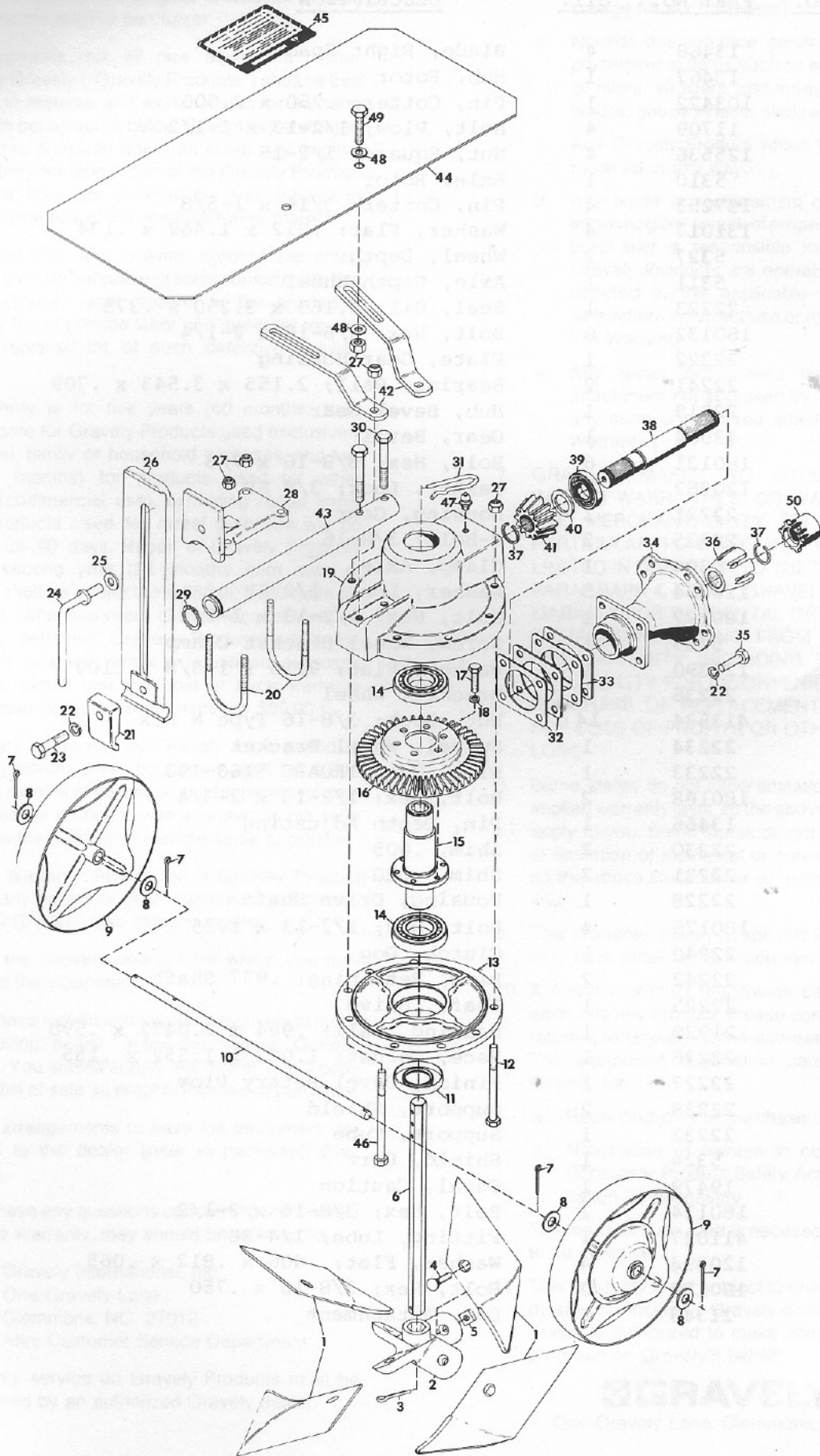

Gravelly
Company, Inc.
New Canaan, Connecticut

GRAVELLY
Gravelly Company, Inc.

ROTARY PLOW

<u>ITEM NO.</u>	<u>PART NO.</u>	<u>QTY.</u>	<u>DESCRIPTION</u>
1	13468	4	Blade, Right Spade
2	13467	1	Hub, Rotor
3	103422	1	Pin, Cotter; .250 x 2.000
4	11709	4	Bolt, Plow; 1/2-13 x 1-1/2
5	125536	4	Nut, Square; 1/2-13
6	5310	1	Axle, Rotor
7	137253	4	Pin, Cotter; 3/16 x 1-5/8
8	131017	4	Washer, Flat; .812 x 1.469 x .134
9	5327	2	Wheel, Depth
10	5311	1	Axle, Depth Wheel
11	22223	1	Seal, Oil; 2.165 x 3.250 x .375
12	180132	6	Bolt, Hex; 3/8-16 x 2-1/4
13	22222	1	Plate, Gear Housing
14	22241	2	Bearing, Ball; 2.155 x 3.543 x .709
15	22219	1	Hub, Bevel Gear
16	43904	1	Gear, Bevel
17	180121	6	Bolt, Hex; 3/8-16 x 7/8
18	120382	6	Washer, Lock; 3/8 SP
19	22221	1	Housing, Gear
20	22235	2	U-Bolt; 3/8-16
21	5304	1	Clamp, Axle
22	120384	5	Washer, Lock; 1/2 SP
23	180177	1	Bolt, Hex; 1/2-13 x 1-1/2
24	5325	1	Screw, Wheel Bracket Clamp
25	120390	1	Washer, Flat; 9/16 x 1-3/8 x .109
26	22236	1	Bracket, Wheel
27	413534	14	Nut, Lock; 3/8-16 Type N Hex
28	22234	1	Swivel, Wheel Bracket
29	22233	1	Ring, Snap TRUARC 5160-193
30	180188	2	Bolt, Hex; 1/2-13 x 2-3/4
31	13466	1	Pin, Depth Adjusting
32	22230	2	Shim, .005
33	22231	2	Shim, .020
34	22228	1	Housing, Drive Shaft
35	180175	4	Bolt, Hex; 1/2-13 x 1.25
36	22240	1	Clutch, Dog
37	22242	2	Ring, Retaining; .937 Shaft
38	22225	1	Shaft, Drive
39	21929	1	Bearing, Ball; .984 x 2.0472 x .590
40	22226	1	Race, Thrust; 1.002 x 1.552 x .155
41	22227	1	Pinion, Bevel Rotary Plow
42	22238	2	Support, Shield
43	22232	1	Support, Tube
44	5324	1	Shield, Dirt
45	19479	1	Decal, Caution
46	180134	2	Bolt, Hex; 3/8-16 x 2-1/2
47	411027	1	Fitting, Lube; 1/4-28
48	120394	4	Washer, Flat; .406 x .812 x .065
49	180120	2	Bolt, Hex; 3/8-16 x .750
50	21343	1	Dog, Attachment



LIMITED FIVE-YEAR WARRANTY

1. This Limited Five-Year Warranty is issued by Gravely International, Inc., only to the original purchaser. If Gravely equipment is leased by Gravely, this Warranty shall extend also to the original lessee as if such lessee were the original purchaser.
2. Gravely warrants that all new equipment manufactured by Gravely ("Gravely Products") shall be free of defects in material and workmanship for the term described in paragraph 4, below. Except as hereinafter provided, this Warranty does not cover any engine, tires or battery forming a part of the Gravely Product. Engine and tires are covered by and subject to separate warranties of the manufacturers thereof.
3. In the event that any Gravely Product warranted hereunder shall be defective or fail to conform with this Warranty, Gravely shall, subject to the provisions hereof, pay for, or provide labor and materials for, the repair or replacement of such defective Gravely Product.
4. This Warranty is for five years (60 months) from purchase date for Gravely Products used exclusively for personal, family or household purposes, and two years (24 months) for products used for other purposes (commercial use), excluding rental firms. Gravely products used for rental purposes will be warranted for 90 days. Repair of Gravely Products after the second year (24 months from date of purchase) shall be subject to a \$50.00 deductible for each repair. (After two years, Gravely agrees to repair or replace defective Gravely Products used exclusively for personal, family or household purposes only to the extent that the cost of such warranty covered repair or replacement exceeds \$50.00.)

Batteries are warranted by Gravely for a period of twelve (12) months only. If a battery shall fail within twelve (12) months of purchase, the replacement cost thereof shall be prorated over a twelve-month term based upon the number of months since purchase.
5. To obtain Warranty Service on a Gravely Product (including any battery or other component not manufactured by Gravely), use this procedure:
 - a. Notify the Gravely dealer from whom you purchased the equipment.
 - b. If you have moved and it is not convenient to notify the selling dealer, notify the nearest Gravely dealer. You should supply this dealer with a copy of the bill of sale as proof of the date of purchase.
 - c. Make arrangements to have the equipment delivered to the dealer (refer to paragraph 6 a., below).
 - d. If you have any questions concerning the Gravely Limited Warranty, they should be referred to:

Gravely International, Inc.
One Gravely Lane
Clemmons, NC 27012
Attn: Customer Service Department
 - e. Warranty service on Gravely Products must be performed by an authorized Gravely dealer.
6. This Warranty does not cover the following:
 - a. Transportation to the Gravely dealership. (If the Gravely dealer provides transportation, he will charge for such service.)
 - b. Normal maintenance services and normal replacement of items such as spark plugs, belts, oil, oil filters, air filters, and mower, plow or cultivator blades, gauge wheels, skids and other wear items.
 - c. Any Gravely Product which has been altered or modified in any way.
 - d. Any repair or replacement occasioned by customer neglect or lack of proper maintenance. (The purchaser is responsible for making sure that Gravely Products are operated and serviced as directed in the applicable manual or service instruction. Incorrect use or maintenance will void this Warranty.)
 - e. Any repair occasioned by the use of any attachment not approved by Gravely. (The use of any such unapproved attachment will void this Warranty.)
7. GRAVELY MAKES NO OTHER EXPRESS OR IMPLIED WARRANTIES, OR WARRANTIES AS TO THE MERCHANTABILITY OR FITNESS FOR A PARTICULAR PURPOSE. ALL WARRANTIES ARE LIMITED IN DURATION TO THE TERMS SET OUT IN PARAGRAPH 4, ABOVE. GRAVELY SHALL HAVE NO LIABILITY FOR INCIDENTAL OR CONSEQUENTIAL DAMAGES RESULTING FROM THE BREACH OF ANY WARRANTY, INCLUDING, BUT NOT LIMITED TO, LIABILITY FOR INCONVENIENCE, RENTAL OR PURCHASE OF REPLACEMENT EQUIPMENT, OR FOR LOSS OF PROFITS OR OTHER COMMERCIAL LOSS.
8. Some states do not allow limitations on how long an implied warranty lasts, so the above statement may not apply to you. Some states do not allow the exclusion or limitation of incidental or consequential damages, so the above limitation or exclusion may not apply to you.
9. This Warranty gives you specific legal rights, and you may have other rights which vary from state to state.
10. A Gravely product registration card is supplied with each Gravely Product. Please complete the card and return it to Gravely at the address listed on the card. The equipment registration card will be used by Gravely for:
 - a. Recording date of purchase.
 - b. Notification of owners in compliance with the Consumer Product Safety Act, should any notification be necessary.The return of such card is necessary for your warranty to be effective.
11. This Warranty is not subject to change or modification by anyone, including Gravely dealers and no Gravely dealer is authorized to make any representations or promises on Gravely's behalf.

 **GRAVELY**

One Gravely Lane, Clemmons, NC 27012