

**GRAVELY TRACTORS**  
DUNBAR, WEST VIRGINIA, U. S. A.  
RETURN POSTAGE GUARANTEED

1922-1962  
*40<sup>th</sup> Anniversary*

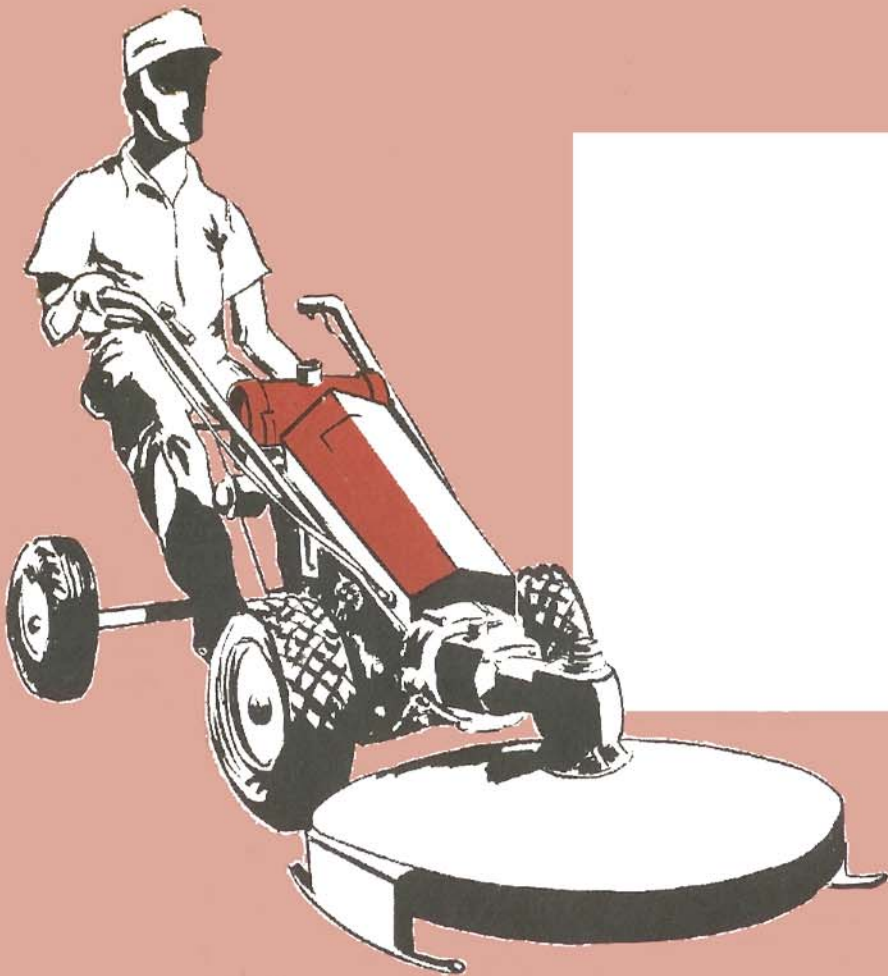

auver  
towa

**FIRST  
CLASS**

*here's  
the literature  
you requested*





# GRAVELLY TRACTORS

DIVISION STUDEBAKER-PACKARD CORPORATION

*Manufacturers*

DUNBAR, WEST VIRGINIA

TELEPHONE: POPLAR 8-1234

**GRAVELLY POWER EQUIPMENT FOR LAWN, GARDEN, FIELD AND FARM.**

## HERE IS THE LITERATURE YOU REQUESTED

Power Vs. Drudgery tells you how the powerful Gravelly saves you hours of back-breaking drudgery--describes the Gravelly Tractor and its attachments in detail.

You will find reasonable claims for these important features:

1. Correct Design
2. Powerful, Reliable Motor
3. Quality Material, fairly priced
4. A choice of tools to fit your particular job

Remember, you buy one power unit--the GRAVELLY Tractor--purchase only the attachments you need!

Budget Plan: If you wish, our representative will give you full details of the Gravelly Budget Payment Plan.

Demonstration--FREE! Any manufacturer can write a forceful booklet, with good printing and copy, and make his proposition sound as good as the next one. But we go a step further.

Don't you agree that a demonstration, on your own ground, under your particular conditions, is worth more than a ton of descriptive literature? That is exactly our offer to you.

Just fill out the card with this letter. It is already addressed to your representative--drop it in the mail. He will arrange a visit or demonstration without obligation.

Request your demonstration today!

P.S. Prices on other side.

Yours sincerely,

GRAVELLY TRACTORS.

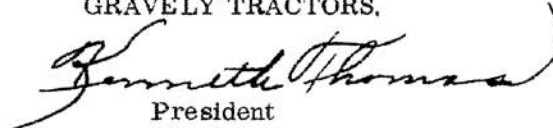
  
President





# GRAVELLY TRACTORS

Division of Studebaker-Packard Corporation

DUNBAR, WEST VIRGINIA

U. S. A.

## DELIVERED PRICE LIST

Effective August 15, 1961

PRICES & SPECIFICATIONS SUBJECT TO CHANGE WITHOUT NOTICE

\*See the notations at the bottom of this price list. Prices shown are delivered at Station. Please ask your Station or Dealer for the exact price delivered to you. Canadian Delivered Prices on Request.

	Net Weight	Price
<b>GRAVELLY TRACTOR MODEL L 6.6 HP COMPLETE, LESS ATTACHMENTS</b>	296 lbs	339.00

### POWER DRIVEN ATTACHMENTS

CULTIVATOR, ROTARY. (Requires Rotary Plow Drive)----	85...	76.75
LEAF-AWAY-----	48...	75.00
MOWER, REEL TYPE 30" Complete-----	137...	144.75
MOWERS, TWO 25" GANG UNITS complete with Hitch and Power Take-Off-----	159...	204.75
MOWER, ROTARY KNIFE 30" (See Below)		
Rotary Knife Mower and Saw Drive (For Saws and Rotary Knife Mower listed below) (Only requires one)-----	40...	66.00
Rotary Knife Mower Assembly (includes blade) (Less Drive)-----	59...	40.50
Leaf Mulcher for Rotary Knife Mower-----	11...	11.25
Chain Guard Attachment, Rotary Knife Mower-----	17...	16.50
Chain Saw Assembly (Less Drive)-----	22...	80.50
Circular Saw Blade 16" (Less Drive)-----	9...	15.25
Saw Guard 18", for Rotary Saw Only (Includes Collar)---	6...	9.50
MOWER, SICKLE 42" (complete with either 2" or 3" Cutter Bar; 3" furnished unless 2" is specified)	87...	93.00
Sickle Mower Cutter Bar Only, either 2" (40 inches long) or 3" (42 inches long). These are standard Cutter Bars for the Gravelly Sickle Mower, for lengths longer than these, add 40¢ per inch for the additional length required-----	34...	23.00
PLOW, ROTARY TYPE complete-----	105...	74.50
PLOW, ROTARY, DRIVE ONLY (Rotary Cultivator Drive)---	55...	51.00
PLOW, ROTARY, DRIVE; including Depth Wheel Assembly, (Optional Rotary Cultivator Drive)-----	75...	63.50
POWER BRUSH, Fine or Coarse Bristles-----	126...	225.75
POWER SPREADER-----	390...	390.00
POWER TAKE-OFF, less Pulley-----	16...	17.00
SNOW BLOWER-----	184...	139.00

### OTHER ATTACHMENTS

CULTIVATOR TOOL HOLDER, complete with Depth Wheels, Carrier, Frames and Shanks for attaching 5 Cultivating Tools (does not include Cultivating Implements), See Cultivating Implements.		
Front Cultivator Tool Holder-----	58...	24.00
Rear Cultivator Tool Holder (Requires Rear Hitch)-----	42...	24.00
<b>CULTIVATING IMPLEMENTS:</b>		
Cultivating Steels, 1-1/4 x 3" --- No. 1156-----		.39 ea.
Cultivating Steels, 1-3/4 x 8" --- No. 2367-----		.40 ea.
Cultivating Steels, 2-1/4 x 8" --- No. 2368-----		.46 ea.
Cultivator Teeth, Regular --- No. 1395-----		.62 ea.
(Requires three 2713's @ 19¢ each; three 2714's @ \$1.13 each)		
Furrower, 10"-----	No. 1161-----	1.95 ea.
Furrower, 12"-----	No. 2621-----	2.60 ea.
Hilfers, 6"-----	No. 1167/8-----	2.50 pr.
Hoes, riveted to Gravelly Shanks, Special-----		4.00 pr.
Improved Sweep, 8"-----	No. 1495-----	.90 ea.
Improved Sweep, 10"-----	No. 1496-----	1.10 ea.
Improved Sweep, 12"-----	No. 1497-----	1.42 ea.
Improved Sweep, 18"-----	No. 1499-----	2.45 ea.
Shovel Steel, 7"-----	No. 2538-----	.79 ea.
Turning Shovels, 7"-----	No. 3824/5-----	2.15 pr.
DISC HARROW, 11" discs, Set of 6 (Requires Rear Hitch)---	43...	34.00
HARROW, Peg Type 18 tooth, with Hitch (Requires Tool-Holder)-----	59...	26.25
HAY RAKE, 48" (Requires Rear Hitch)-----	107...	53.00

Group 1 \*Prices shown above are delivered at the Stations in the following cities:

Connecticut ..... Norwich  
 Delaware ..... Wilmington  
 Indiana ..... Fort Wayne  
 Indiana ..... Indianapolis  
 Kentucky ..... Lexington  
 Maryland ..... Annapolis  
 Massachusetts (Boston) ..... Brockton  
 Michigan ..... Flint

Missouri ..... Kirlewood  
 New Jersey ..... Freehold  
 New Jersey ..... Stewartsville  
 New York ..... Batavia  
 New York (Albany) ..... Latham  
 New York (N.Y.) ..... Mount Kisco  
 New York ..... Olean  
 Ohio ..... Columbus

Ohio ..... Dover  
 Ohio ..... Toledo  
 Ohio ..... Wooster  
 Ohio ..... Worthington  
 Pennsylvania (Pittsburgh) ..... Butler  
 Pennsylvania ..... Gettysburg  
 Pennsylvania (Phila.) ..... Haverford  
 Pennsylvania ..... Uniontown

Tennessee ..... Nashville  
 Vermont ..... South Barre  
 Virginia ..... Roanoke  
 Virginia ..... Warrenton  
 West Virginia ..... Charleston  
 West Virginia ..... Nitro  
 West Virginia ..... Wheeling

Group 2 For approximate prices of equipment delivered at Stations in the following cities, add 1%

Florida ..... Lakeland  
 Florida ..... Orlando  
 Georgia ..... Albany  
 Georgia ..... Atlanta

Illinois ..... Manteno  
 Iowa ..... Davenport  
 Kansas ..... Fort Scott  
 Louisiana (New Orleans) ..... Metairie

Minnesota ..... Minneapolis  
 Mississippi ..... Jackson  
 North Carolina ..... Charlotte  
 Oklahoma ..... Tulsa

South Carolina ..... Columbia  
 Texas ..... Dallas  
 Texas ..... San Antonio  
 Wisconsin ..... Milwaukee

Group 3 For approximate prices of equipment delivered at Stations in the following cities, add 3%

California ..... Los Angeles

California ..... Richmond

Washington (Seattle) ..... Lynnwood

Printed in U.S.A.

	Net Weight	Price
POWER BARROW-----	92...	56.00
SEEDER SPREADER, 5' (Requires Rear Hitch)-----	126...	113.00
SULKY, RIDING (Requires Rear Hitch)-----	45...	43.00
SULKY, STEERING (Requires Rear Hitch)-----	59...	73.50
ROLLER, WATER BALLAST, 32" (Requires Rear Hitch)---	148...	52.50
SCRAPER BLADE-----	13...	7.75
SNOW PLOW, BLADE TYPE 43", complete with Hitch	112...	52.75
TRANSPORTATION CART, Riding (Requires Rear Hitch)---	140...	82.50
TURN PLOW, 7" with A-466 Draw Bar (Requires Rear Hitch)-----	27...	22.00

### ACCESSORIES

ATTACHMENT CLUTCH CONTROL KIT-----	2 lbs. 6 oz.	5.00
BATTERY, DELCO-----	38...	23.95
DUAL WHEELS, Complete with Tires, Tubes, Spacers, and Rims-----	54...	53.50 pr.
DUAL WHEEL SPACERS (Less Tires, Tubes, Rims)-----	40...	20.75 pr.
EXTENSION AXLES (Gives 35" Wheelbase)-----	27...	24.95 pr.
GEAR REDUCTION WHEELS (Steel, cleated)-----	12 1/2...	78.00 pr.
GEAR REDUCTION WHEELS (Pneumatic Tires)-----	120...	68.00 pr.
GOVERNOR, Complete (Ready to Install)-----	5...	26.25
HITCH, REAR-----	6...	7.00
IGNITION SWITCH-----	3 oz.	1.30
OIL PRESSURE GAUGE, Complete (Ready to Install)-----	1...	3.25
PLANTER DRILL, Less Blades (Rotary Plow or Rotary Cultivator Drive Required)-----	20...	19.00
Large Blades, Set of Four-----	10...	8.50 set
Small Blades, Set of Four-----	6...	6.00 set
SEMI-PNEUMATIC TIRES-----	34.5 pr.	29.50 pr.
SICKLE GRINDER-----	16...	11.50
SLIPPER-----	1 lb. 6 oz.	15.00
SNOWLOWER CASTERS-----	6...	17.00 pr.
STARTER KIT complete with Battery Brackets and Cables but LESS Battery-----	40...	64.00
SULKY CUSHION-----	5...	3.50
TIRE CHAINS-----	12...	9.30
TRACTOR COVER-----	4...	12.00
TRACTOR STAND-----	6...	5.25
TRIPLE-PURPOSE WRENCH-----	4...	3.20

### USE-MULTIPLIER ATTACHMENTS

(These attachments are available on SPECIAL ORDER from the Factory through your Gravelly Representative).

BATTERY CHARGER-----	6...	16.75
BLITZ-FOGGER-----	6...	16.25
DUMPING SCOOP-----	100	66.00
ENGINE HEATER-----	12 oz.	9.75
GENERATOR (Requires Gravelly P.T.O.)-----	95...	222.00
HOME 'N GARDEN SPRAYER-----	130...	212.00
HOME 'N GARDEN BOOM ASSY.-----	15...	97.00
LAWN AERATOR-----	115...	85.50
LAWN SWEEPER, 30"-----	112...	101.50
LAWN SWEEPER, 75" (Gang)-----	387...	341.00
SINGLE-ROW SEEDER & HITCH-----	38.5	51.00
UTILITY PUMP (Requires Gravelly P.T.O.)-----	52...	101.00

### GRAVELLY CLEAN-CUT MOWERS

CLEAN-CUT 70-----	890...	1425.00
CLEAN-CUT 35		
Recoil Starter-----	550...	655.50
Electric Starter-----	550...	710.00
CLEAN-CUT 24		
Recoil Starter-----	315...	399.00
Electric Starter-----	315...	456.00
CLEAN-CUT 20-----	116...	166.00

# **GRAVELY**

## **EASY PAY PLAN!**

*Featuring*

- **20% Down Payment!**
- **18 Months On Balance!**
- **GRAVELY Finance!**
- **Pay By Mail - Convenient!**
- **Modern, Easy Way To Buy!**



### **POWER while you pay!**

Now you have the benefit of Gravelly Power while you pay!

This new, lower down payment plan and extended terms, make it easy and convenient to use the modern, accepted way to purchase durable products.

This plan allows you to buy the best--FIRST! You need not consider buying inferior equipment, or one not well suited to your needs as Gravelly. Instead, by using this Factory Finance Plan, you begin immediately to enjoy the benefits and satisfaction of owning the best--the powerful Gravelly Tractor and your choice of over 30 different Tools and Attachments.

**TURN TO REVERSE SIDE FOR  
DOWN PAYMENT CHART**

### **ADVANTAGES**

Save Finance Costs...

Because our charges are usually less than most installment plans. You save, because our plan's purpose is to help you purchase, rather than make a large profit from financing.

### **Continuity - Factory Financing!**

Our policy has always been to manufacture a good product and to give complete, nationwide service. Service to the customer has been extended to include helping people buy.

This continuity of manufacturing and service is your best guarantee of the quality that has built the wonderful reputation of Gravelly Equipment since 1922.



**SEE YOUR *GRAVELY* DEALER FOR QUALITY EQUIPMENT**

# To Figure Your Low-Cost Payment-



## HOW TO USE THIS CHART

From the total Cash Price subtract the Down Payment and/or trade-in allowance. The difference is the Unpaid Balance.

Adjust the Down Payment, (either more or less) so the Unpaid Balance will equal the nearest figure as shown on the extreme left hand side of the chart, for example:

	<u>Actual</u>	<u>Correct</u>
Total Cash		
Price . . . .	\$453.29	\$453.29
20% Down		
Payment . .	<u>90.66</u>	<u>93.29*</u>
Unpaid		
Balance . .	362.63	360.00
Nearest Unpaid Balance on Chart . . . . .		360.00
Increase Down		
Payment . . . . .		2.63*

On the chart opposite the Unpaid Balance under the Number of Months to Run, you will find the Amount of Contract and Amount of Monthly Payment.

When Unpaid Balance is more than \$500.00, add the figures for two balances whose sum would equal the desired amount

Please note:

	Unpaid
Minimum contract for:	Balance
6 months . . . . .	\$20.00
12 months . . . . .	55.00
18 months . . . . .	90.00

**GRAVELY TRACTORS**  
DIVISION OF STUDEBAKER-PACKARD CORPORATION  
DUNBAR, WEST VIRGINIA

Unpaid Balance	6 MONTHS		12 MONTHS		18 MONTHS	
	Mo. Pay.	Amt. of Contract	Mo. Pay.	Amt. of Contract	Mo. Pay.	Amt. of Contract
20.00	3.87	22.02	--	--	--	--
25.00	4.50	27.00	--	--	--	--
30.00	5.34	32.04	--	--	--	--
35.00	6.17	37.02	--	--	--	--
40.00	7.00	42.00	--	--	--	--
45.00	7.84	47.04	--	--	--	--
50.00	8.67	52.02	--	--	--	--
55.00	9.50	57.00	4.86	58.32	--	--
60.00	10.34	62.04	5.30	63.60	--	--
65.00	11.17	67.02	5.75	69.00	--	--
70.00	12.02	72.12	6.19	74.28	--	--
80.00	13.74	82.44	7.07	84.84	--	--
90.00	15.45	92.70	7.96	95.40	5.45	88.10
100.00	17.17	103.02	8.84	106.08	6.06	109.08
110.00	18.89	113.34	9.72	116.64	6.67	120.06
120.00	20.60	123.60	10.60	127.20	7.27	130.86
130.00	22.32	133.92	11.49	137.88	7.88	141.84
140.00	24.04	144.24	12.37	148.44	8.48	152.64
150.00	25.75	154.50	13.25	159.00	9.09	163.62
160.00	27.47	164.82	14.14	169.68	9.69	174.42
170.00	29.19	175.14	15.02	180.24	10.30	185.40
180.00	30.90	185.40	15.90	190.80	10.90	196.20
190.00	32.62	195.72	16.79	201.48	11.51	207.18
200.00	34.34	206.04	17.67	212.04	12.12	218.16
210.00	36.05	216.30	18.55	222.60	12.72	228.96
220.00	37.77	226.62	19.44	233.28	13.33	239.94
230.00	39.49	236.94	20.32	243.84	13.93	250.74
240.00	41.20	247.20	21.20	254.40	14.54	261.72
250.00	42.92	257.52	22.09	265.08	15.14	272.52
260.00	44.64	267.84	22.97	275.64	15.75	283.50
270.00	46.35	278.10	23.85	286.20	16.35	294.30
280.00	48.07	288.42	24.74	296.88	16.96	305.28
290.00	49.79	298.74	25.62	307.44	17.57	316.26
300.00	51.50	309.00	26.50	318.00	18.17	327.06
310.00	53.22	319.32	27.39	328.68	18.78	338.04
320.00	54.94	329.64	28.27	339.24	19.38	348.84
330.00	56.65	339.90	29.15	349.80	19.99	359.82
340.00	58.37	350.22	30.04	360.48	20.59	370.62
350.00	60.09	360.54	30.92	371.04	21.20	381.60
360.00	61.80	370.80	31.80	381.60	21.80	392.40
370.00	63.52	381.12	32.69	392.28	22.41	403.38
380.00	65.24	391.44	33.57	402.84	23.02	414.36
390.00	66.95	401.70	34.45	413.40	23.62	425.16
400.00	68.67	412.02	35.34	424.08	24.23	436.14
410.00	70.39	422.34	36.22	434.64	24.83	446.94
420.00	72.10	432.60	37.10	445.20	25.44	457.92
430.00	73.82	442.92	37.99	455.88	26.04	468.72
440.00	75.54	453.24	38.87	466.44	26.65	479.70
450.00	77.25	463.50	39.75	477.00	27.25	490.50
460.00	78.97	473.82	40.64	487.68	27.86	501.48
470.00	80.69	484.14	41.52	498.24	28.47	512.46
480.00	82.40	494.40	42.40	508.80	29.07	523.26
490.00	84.12	504.72	43.29	519.48	29.68	534.24
500.00	85.84	515.04	44.17	530.04	30.28	545.04

Minimum Finance Charge - \$2.00



# NOW!

from

# GRAVELY



## A Rotary Mower 50" Wide !!

Tooling's almost complete and production's about to begin! The new 50 inch rotary mower attachment... the one you've asked for so often... will be ready for spring delivery!

Three 17 inch staggered blades operated from a gear-driven drive shaft make this the biggest, newest, best thing yet for mowing large-area lawns. Adjustable spindles with permanently lubricated housings give you a choice of cutting heights from 1 to 4 inches. Skids carry the unit up and over humps and bumps, prevent scalping. Two front-mounted, extra large, 8 inch casters make the "Top Hat" mighty maneuverable! There's a side discharge vent to release mulched grass and prevent windrowing, an optional roller bar to prevent damage to ground-level markers in cemetery work. And like all our power attachments, you get Gravely performance in the "Top Hat" plus swivel action and safety-clutch protection.

This is the one YOU asked for. Look for the "Top Hat", the aristocrat of rotary lawn-mowers... ask for a demonstration... and we won't have to say another word.

**GRAVELY TRACTORS**  
DIVISION STUDEBAKER-PACKARD CORPORATION  
DUNBAR, WEST VIRGINIA



# GRAVELLY



**MORE PERFORMANCE**

**MORE POWER**

**MORE FOR YOUR MONEY**



# GRAVELY

## Are You Getting the Rewards of Time-and-Work-Saving Power?

Modern country living is enjoyable today only because POWER takes the drudgery from the chores that come with country living.

To give yourself the leisure to enjoy your home, to get the fullest satisfaction from doing your work easily and efficiently, to have an attractive home with well-kept grounds . . . you must use POWER.

But the right power tools must be selected with care.

To get the most effective tools for your money, you must be sure they are designed for the job, built correctly, and are backed by a reliable service organization.

The Gravely meets these qualifications. It is designed right, manufactured right—and comparing dollar cost per unit of horsepower, you pay less for the Gravely. As a dividend, you get the finest tractor money can buy, with quality features unobtainable in other tractors.

Even more important than an economical price is the power delivered to the job. The worst mistake you can make is to buy equipment that doesn't deliver the power you need!

The Gravely Tractor has power to spare! Now, 6.6 HP!

The mechanical features of the Gravely are discussed in the last pages of this booklet. First, you will want to know just what the Gravely can do for you in solving your particular problems. In the pages to follow we will show you how each Gravely Attachment can make your country living more pleasant and productive.

Remember, the first requirement of any good equipment is power to do the job right.

The second is versatility—the ability to do many jobs well with one power unit.

**YOU BUY ONLY ONE TRACTOR . . .**

**Select the Attachments You Need!**

ONLY FOUR BOLTS TO REMOVE TO CHANGE POWER ATTACHMENTS

POWER CULTIVATE

2

PLOW PERFECT SEEDBED

HAUL ½-TON LOADS





# POWER vs. Drudgery

## Powerful 6.6-HP **GRAVELY** Tractor Offers 30 Tools To Save You Work!

The amazing versatility of the Gravelly Tractor is illustrated briefly by the pictures on these two pages. You have a choice of performance-proved power tools that save you work and worry all year long!

Versatility, with Gravelly Equipment, is more than just variety. It is a year-round selection of power tools that are designed as an integral part of the Gravelly Tractor . . . balanced for easy handling, geared right for maximum efficiency . . . driven by splined steel shafts and gears direct from the Gravelly Engine.

Variety in itself has no value. Gravelly gives you variety plus more power at the job and the most sturdy and rugged design. The proof is in the performance of the powerful Gravelly and its power tools. Gravelly does more jobs better than any other equipment!

With the Gravelly Tractor, and its optional electric starter, for the first time you can truly bring push-button power to your jobs.

These next pages show you each Gravelly Attachment. You will see certain Attachments that will solve your particular upkeep and gardening problems. Awaiting you is the solution to your every lawn, garden and field problem! Select the tools you need for POWER instead of drudgery!

"I bought a Gravelly last July and I wish to tell you that it is the very finest piece of equipment I have ever had on my place.

I have 2¼ acres and find it takes all the work and drudgery out of taking care of my yard and garden.

Before I got my Gravelly I owned two other makes of garden tractors and had decided there wasn't any small tractor that I would have on my place. Then I saw my first Gravelly. I arranged for a demonstration and I was very cautious about buying again, but finally I decided that it was what I wanted. And believe me it has come up to all my expectations and I can't praise it too highly."

KEITH DILLARD  
West Frankford, Illinois



**MOW LAWNS**



**MOW AND MULCH WEEDS**



**MOW WEEDS AND BRUSH**



**REMOVE SNOW**



**CLEAR LAND, CUT TIMBER**



**MOW FINE LAWNS**



# ROTARY PLOW - GRAVELY TWIN-TOOL C

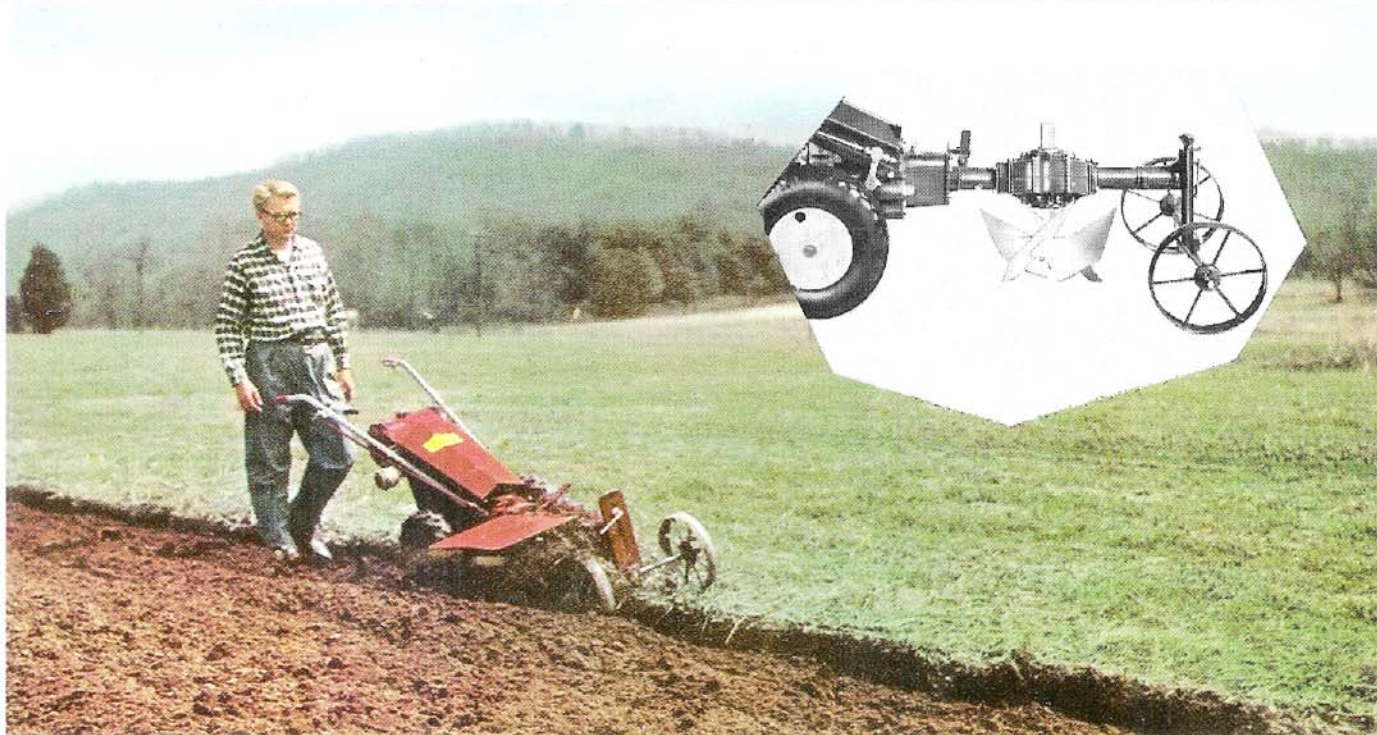

## PERFECT SEEDBED IN ONE OPERATION

The Gravelly Rotary Plow gives you complete independence from the delay and inconvenience of depending on someone else to prepare your ground.

You plow when the ground is right, get better prepared ground, a better garden, with less work!

The Gravelly Rotary Plow prepares a better seedbed on an entirely different principle from the traditional turnplow and harrow. The Power-driven Plow cuts into the sides and bottom of the furrow 800 times a minute at the normal working speed of your motor . . . one of the four cutting blades is biting into the soil every half inch!

Weeds, trash and fertilizer are cut in and thoroughly mixed with the soil.



Unusually hard ground, or virgin sodland, is plowed effectively by using Gravelly Gear Reduction Wheels. These special wheels reduce the forward speed of the tractor by half, without affecting the attachment speed. A demonstration will assess your need.

## DEEP, EVEN SEEDBED

This action gives you a deep, mellow seedbed all the way down! In hard soils you can plow as deep as 7 inches. In soft soil, 10 inches. The plow cuts a furrow as wide as 10 inches, depending upon the soil conditions. You have a mellow, easy-to-work garden all summer long—less work to prepare, less work to cultivate!

## EASY TO HANDLE

Operation of the Rotary Plow is easy when plow is properly adjusted to the soil.

## SAFETY CLUTCH PROTECTED

The tough, high-carbon steel blades are shaped to move aside stones, roots and other obstacles less than twice the size of your doubled fist. Larger obstacles operate the Gravelly Safety Clutch, which protects both tractor and attachment.

"This sod had not been plowed in years and the hay, timothy, clover and witch grass was above the gas tank in height and just as thick as it could be. It turned under beautifully."

MAJOR GEORGE C. COE  
Center Lovell, Maine

## TURNPLOW

For those who prefer it, a conventional 7 inch Turnplow is available. Gear Reduction Wheels must be used. Rear Hitch required.



**TERRACING:** Since the Plow throws the soil to the right, removal of the dirt shield and plowing in one direction will terrace grounds quickly and easily.



**HILLING** for such plants as sweet potatoes is carried out quickly and easily. Simply make approximately six cuts with the plow and perfect hill is formed!



# GARDENING - ROTARY CULTIVATOR

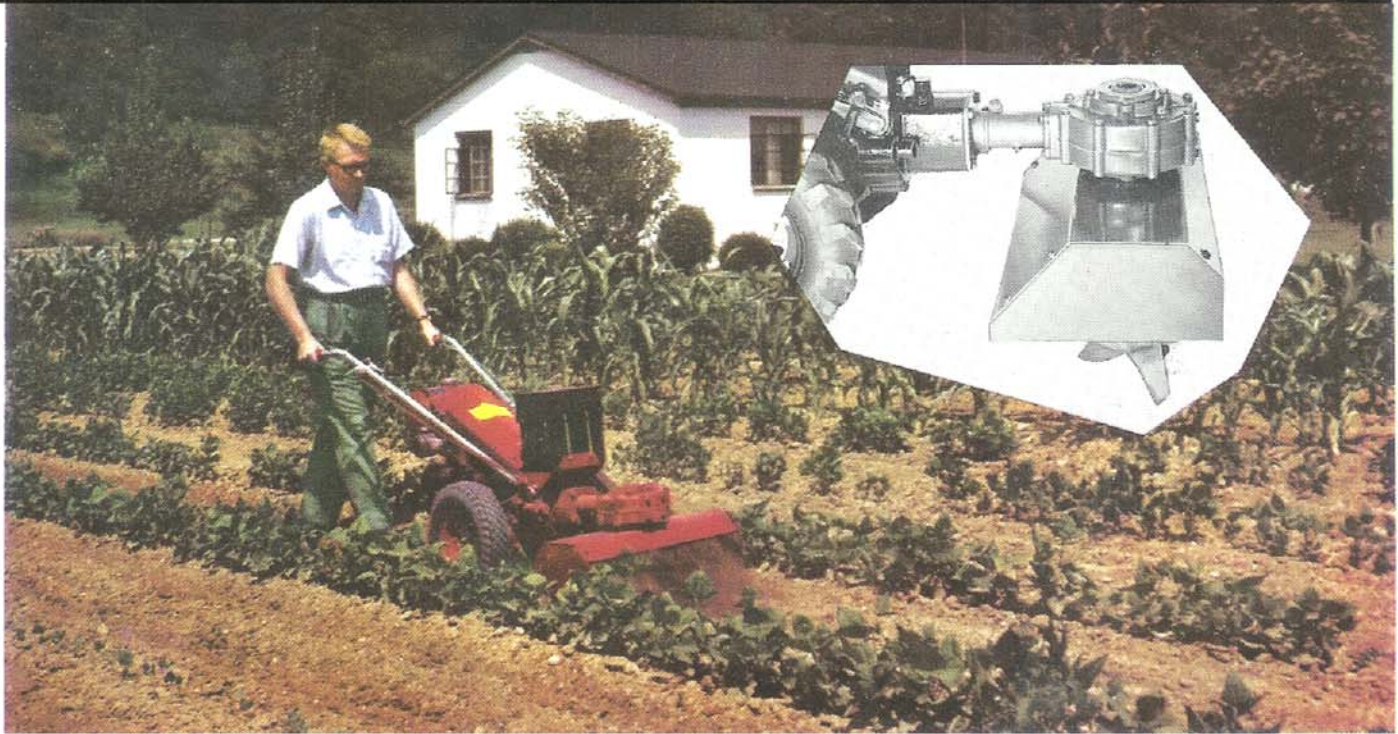

## POWER CULTIVATION FOR YOUR GARDEN

Now you cultivate with power! The Gravelly Rotary Cultivator makes your garden chores a snap—your garden is weed-free, aerated—with no effort except guiding the powerful Gravelly!

The Rotary Cultivator Hood has detachable sides, a great convenience in your gardening work. When working bushy row crops, keep the sides on . . . this protects the plants, gives a smooth cultivated area between the rows.

When working crops such as sweet corn, where the best practice is to throw the dirt into the plants, remove the sides. The center of the row will be cleanly cultivated, and a ridge of tilled soil will be moved into the plant row . . . the same effect as if you hand-hoed the soil, pulling it around the plants.



Strawberry Cultivation is fast and easy . . . and the Rotary Cultivator is perfect for Strawberry renovation, accurate control of row mat plantings. Any berry crop is cultivated better with the Gravelly!

The sturdy Rotary Cultivator attaches to the Gravelly Rotary Plow with only four bolts. The tines, of strong, high-carbon steel, have a special self-sharpening design, are strong and dependable. Width: 26 inches. Depth of cut: three inches.

## SAFETY CLUTCH PROTECTED

No attachment breakage with the Gravelly Rotary Cultivator . . . instead, if you hit a rock or other obstacle the Safety Clutch operates and protects attachment and tractor from damage.

## TWIN-TOOLS MAKE YOUR GARDENING EASY

The Gravelly Rotary Plow and Rotary Cultivator combination gives you a twin-purpose attachment that handles your gardening jobs with POWER all summer long.

In the spring, the Rotary Plow prepares a perfect seedbed in one operation. Then, after your garden is in, attach your Rotary Cultivator to your Rotary Plow Drive . . . and you have power cultivation the rest of the season!

## LAWN RENOVATION

The Rotary Cultivator can be used for Lawn Renovating, for a smooth, fine grass seedbed. Plow first, then use the Rotary Cultivator in reverse to leave an unmarked, level grass seedbed.



PLANTER DRILL is an inexpensive attachment that uses the Rotary Plow Drive as power take off. It digs a circular hole, 11" in diameter for the small blades, 21" for the large, to a maximum depth of 24 inches. Perfect tool for fast, easy digging for planting trees and shrubs.



DITCH DIGGING is done by simply making several cuts in the same furrow, dropping the Rotary Plow a little more each time. For deep ditching, longer shafts are available.



# TOOL CULTIVATION - GRAVELY MAKES

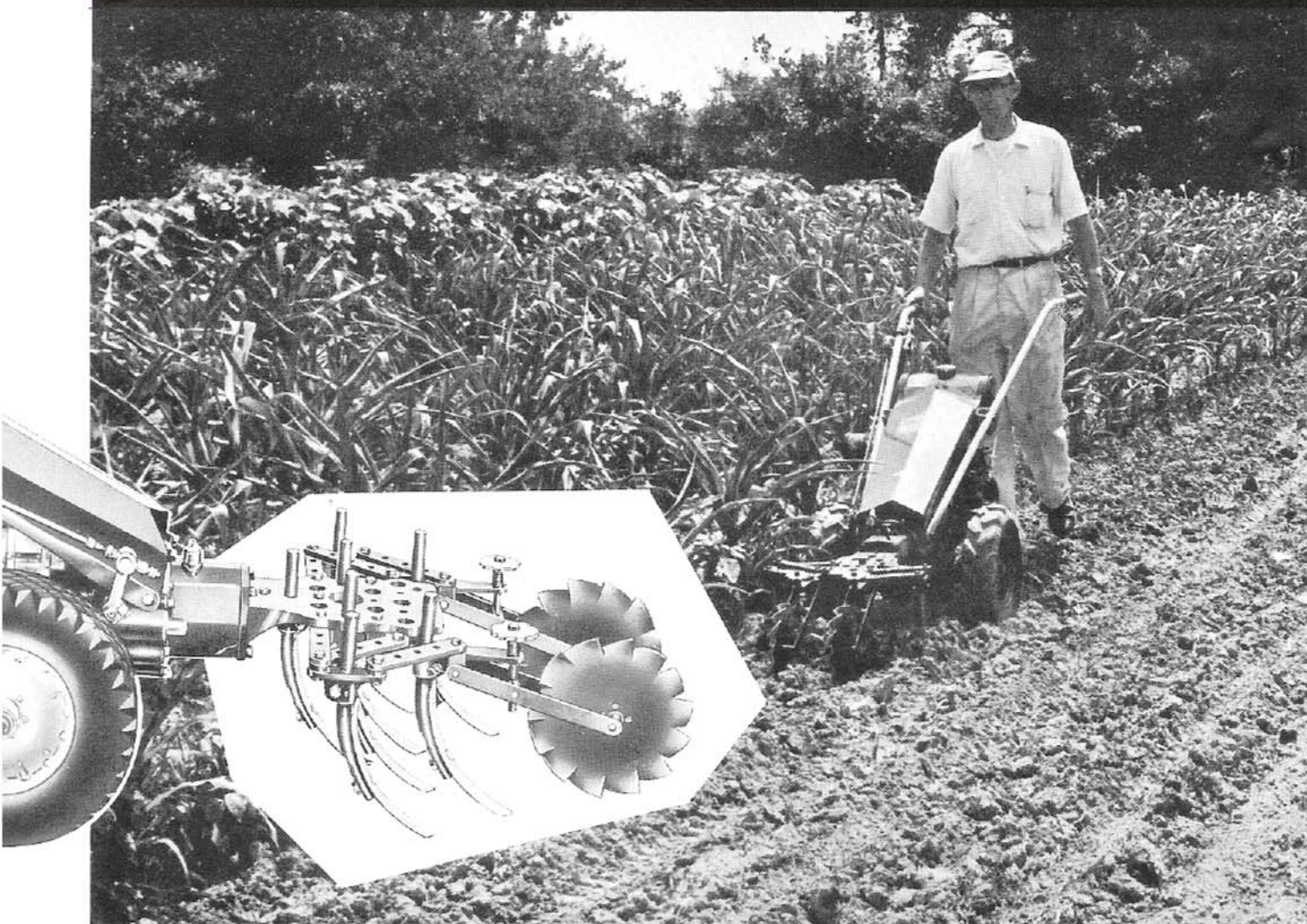

Get rid of old-fashioned, back-breaking hand and hoe methods of cultivation! Instead of hours of drudgery, a few minutes with the powerful Gravely and your garden is weed-free!

Remember, you plow once or twice a season, but you cultivate many times. Think of the time and effort you can save by doing this work with **POWER!**

Besides the saving in time and energy, you have the added pleasure of doing your work right—and when you want it done!

The Toolholder and Cultivating Tools are out in front—you can see where you are cultivating without strain. The Tractor and Cultivator are balanced for easy guiding and turning. This easy handling, out-in-front Toolholder protects your plants from damage.

The arrangement of tools is flexible. The Parallel Bars on the Toolholder expand and contract with a

simple adjustment. You can cultivate a width of from eight to 30 inches. For even wider cultivation, extra sections of the Parallel Bars are attached to the toolholder.

The depth of cultivation is adjusted by means of a Handwheel on the Depth Adjusting Wheels. This allows you to set the exact depth needed for any job quickly and effortlessly. In addition, each of the steels can be set individually, so you can cultivate deeper in the center and shallower at the sides.

All the different cultivating implements shown on these pages are used on the same Toolholder. You select only those needed for your conditions.

Your Gravely meets all your cultivating requirements—makes your gardening a pleasant task instead of drudgery!



# GARDENING FUN - GARDENING TOOLS

## All Tools Used On the Same Toolholder

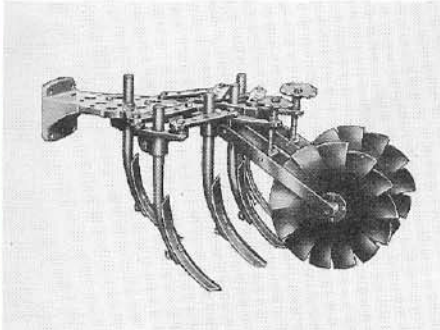

**FIVE STEEL SET-UP** is the standard arrangement, uses 1 $\frac{1}{4}$ " steels. Extra steels and shanks may be purchased. The picture at the top of page 6 shows the method of arrangement when seven steels are used. Steels are available in 1 $\frac{1}{4}$ ", 1 $\frac{3}{4}$ " and 2 $\frac{1}{4}$ " sizes. All cultivating tools are used on the same toolholder, are interchangeable.

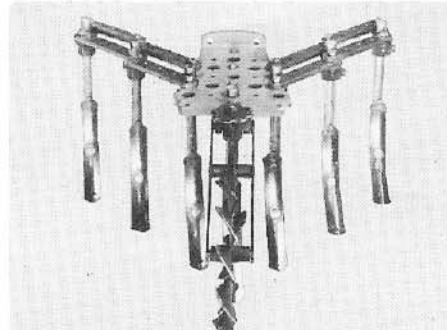

**SEVEN STEEL V SET-UP** uses one Depth Adjusting Wheel with the parallel bars arranged to form a V. Depth is obtained by a single adjustment of the Depth Wheel. The Cultivator will follow the contour of the ground closely, and the last two steels shield foliage and vine crops so they will not be bruised by the wheels.

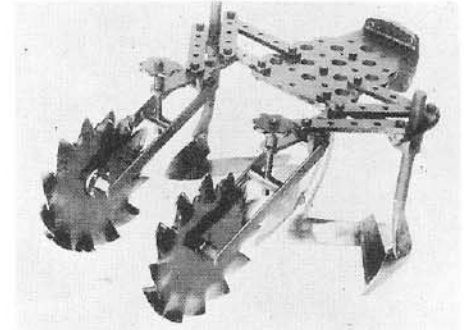

**SWEEP AND HOE SET-UP** uses an improved Sweep in the center and a right and left Gravelly Hoe on either side. The Sweep may be obtained in 8, 10, 12 and 18-inch sizes. The Sweep clears the center weeds and trash, and the special Gravelly Hoes eliminate most of the hand work close to the plants.

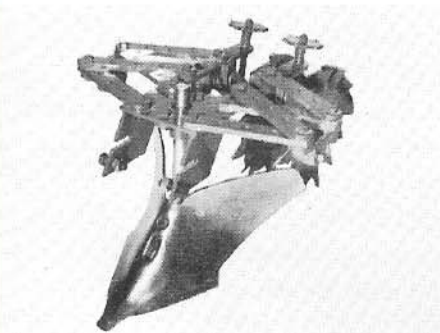

**FURROWERS** are available in 10 or 12-inch sizes, may be used front or rear to lay off rows for planting. Many users also find it a good tool for digging potatoes. For smaller furrows, seven-inch shovel steels are available. These are very handy for laying off small seed crops, and can be used for center row cultivation.

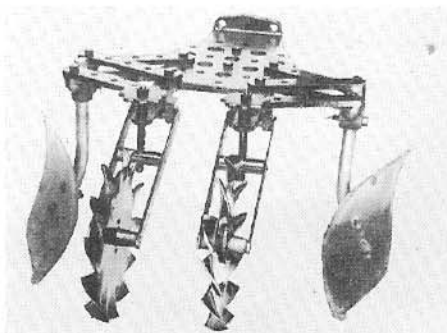

**6-INCH HILLER SET-UP** uses right and left hillers, can be used for closing rows as well as hilling. They throw dirt away from or around the plants, as you desire. You can use a furrower in the center at the same time, bringing dirt from the center of the row to the hillers, which in turn heap it around the plants.

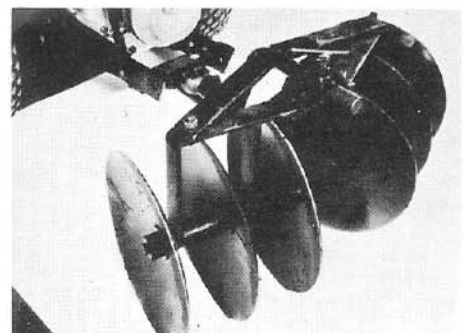

**DISC HARROW** is used for berries, flowers, discing in cover crops. The six 11-inch discs are adjustable as to angle. A heavy weight may be added if needed. Rear Hitch required.

### REAR TOOLHOLDER PLATE

For those users who prefer to use their cultivating tools in the rear, eliminating tire tracks, the Rear Hitch Toolholder plate is available. Parallel Bars are attached to it in the same manner as the Front Toolholder.

The Rear Toolholder is particularly useful when furrowing, and in digging potatoes with the furrower.

All cultivating tools and set-ups may be used on the Rear Toolholder. The Front Toolholder or Attachment Boss must be used on the front of the tractor when the Rear Toolholder is used, to protect the transmission from dust and grit. Rear Hitch is required.

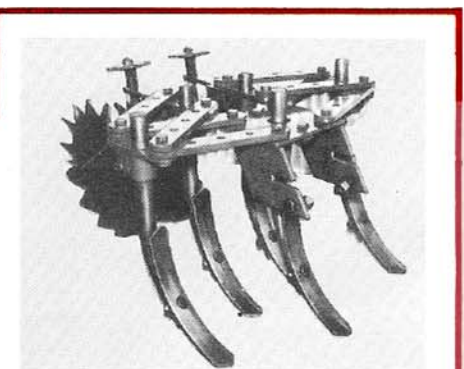



# REEL MOWER - GRAVELY MOWING F

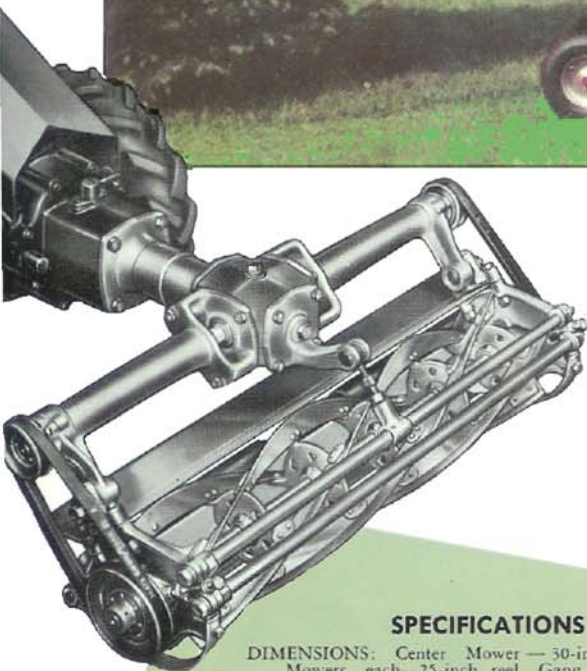

## SPECIFICATIONS

**DIMENSIONS:** Center Mower—30-inch reel. Gang Mowers, each—25-inch reel. Gang Mowers overlap Center Mower 2½ inches. Cutting swath of complete unit is 75 inches.

**GEARS:** All gears are of machine cut steel and enclosed.

**CASTINGS:** Malleable.

**BEARINGS:** Timken Roller and Ball Bearings throughout.

**CUTTING HEIGHT:** ¼ to 3 inches.

**SELF-LAPPING:** Center units and Gang units are self-lapping by reversing Mowers.

## 30-Inch Power-Driven Reel Mower For Clean-Cut Lawns

You will be truly proud of your lawn if you care for it with a Gravelly 30-inch Reel Mower.

The Gravelly Reel Mower is built to the exacting standards demanded by men who do volume mowing at parks, cemeteries, and industrial plants. The Gravelly gives you twice the power of the usual power mower—and 12 inches more cut each pass!

Your lawn will be lovelier because the Gravelly has certain features that give you clean, smooth cutting. The Reel Mower has Swivel Action, which means it follows the ground contour— independent of the Tractor wheels. It doesn't streak your lawn. A Safety Clutch protects the reel and tractor from damage if you hit rocks or other objects.

You owe it to your lawn—and to yourself—to see the Gravelly Reel Mower in action.

## NEW EASE AND SPEED—

### Riding Sulky

You can do more work, with less effort, when you ride. A Gravelly Riding Sulky lets you work steadily, comfortably, with a minimum of fatigue. The Tractor is easier to handle . . . even physically handicapped people can enjoy doing their own mowing! The Sulky has a comfortable seat and precision-bearing pneumatic tires both for riding comfort and to protect your lawn.





# FOR LOVELY LAWNS - GANG MOWERS



## 75-Inch Gang Mower Mows Large Lawns Fast!

The 75-inch cut Gang Mowers make short work of large area mowing. The 25-inch Gangs are attached to the 30-inch Reel Mower in a few minutes, removed as quickly.

The complete unit is **power-driven**. The Gangs float over the ground contour because they are attached to the Center Mower by a flexible coupling. They always follow ground contour, regardless of the position of the tractor wheels.

With the Steering Sulky, you will have a new and amazing experience in easy mowing—easy guiding and maneuvering. It takes the last bit of work from volume mowing, turns it into a pleasant and enjoyable task.

For a truly fine lawn, use the Gravely Gang Mowers!

## RIDE WHILE YOU MOW!

### Steering Sulky

The last word in mowing ease . . . so easy it's like driving a car with power steering! Instant, precise control and response . . . even trimming work is fast and accurate.

One-finger steering, even on rough ground. And the Steering Sulky is so maneuverable that you mow a circle 14 inches in diameter with Gangs!

## "A Fine Lawn Deserves A Fine Reel Mower"

Only the Gravely Reel and Gang Mowers give you streak-free mowing. On most mowers, caster wheels support the mower in front. The grass is not cut by the reel because it follows the caster wheels. The next day, the uncut grass springs back up to show as streaks in the lawn. But the Gravely Reel rides on rollers which follow the cut! You get smooth, even, streak-free mowing.

Many built-in safety features protect your investment. You have a Reel that holds its adjustment, a safety clutch to "give" if you hit an object that would damage the Reel.

The Gravely Reel and Gang Mowers are convenient to use and adjust. One turnbuckle on each unit controls height adjustment from  $\frac{3}{4}$ " to 3" inches. Four bolts remove and replace the Reel Mower. 2 pins and a coupling for the Gangs. The design allows you to mow under trees and shrubs—and the reverse means you back up with power.





# ROTARY MOWING - LEAF MULCHING



## One Mowing Unit For Lawns and Weeds!

Now you cut the tough weeds, and the fine lawn, with one powerful Rotary Knife Mowing attachment!

The new Gravely Rotary Mower gives you a big cut—30 inches wide—to make short work of mowing jobs.

Think of the advantages of one mowing unit to do both your mowing jobs! You mow the lawn cleanly and evenly, and at the same time get rid of unsightly Buckhorn and Dandelion stems. This gives you a cleaner, lovelier lawn. And the grass is not windrowed on your lawn . . . instead, most of it is shredded into a mulch that quickly decays into organic matter. This organic matter enriches your lawn, makes it better nourished!

Then, with the same mower, you go right on mowing weeds,

without loss of time! And when you mow weeds with the Gravely Rotary Mower, the weeds will practically disappear. When properly operated, the mower will cut and shred the tallest weeds . . . and remember this big advantage! The Gravely Rotary Mower is **SELF-PROPELLED!** No pushing or pulling . . . you just guide the Gravely, the Tractor does the work. You even have a reverse.

And the Rotary Mower trims and cuts closer to obstacles than the conventional mowers. You get within an inch of buildings, fences, walks—this saves a lot of hand trimming!

## Design Simplicity Means Low Cost—Low Maintenance!

This picture shows you the rugged construction, the complete simplicity of design that means long lasting satisfaction. The two knives are heavy, have curved tips that lift the grass into the fast-whirling blades that are slanted to slice—not beat—the grass! This means greater cutting efficiency.

The few parts mean low maintenance. The knives are sharpened quickly and easily. There are no complicated adjustments . . . simply change the collars for the height you require. These collars are different sizes, and by using them in combination you obtain a cutting height of from 1½ to 2½ inches.

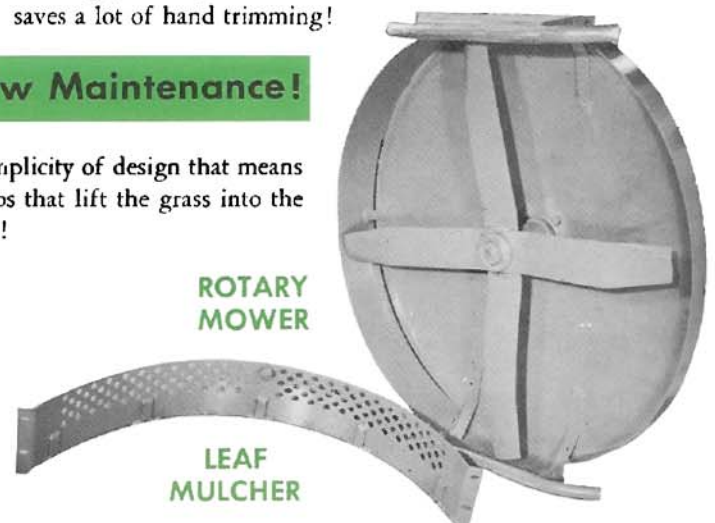



# - CHAIN & CIRCULAR SAWING



## NO MORE Leaf Raking— NO MORE dangerous leaf fires!

Now you can say good-bye to the back-breaking drudgery of raking leaves . . . the unpleasant smoke and danger of fire from leaf burning.

The Gravely Leaf Mulcher attaches to the Rotary Knife Mower in a few minutes. Then off you go, clearing a 30" swath . . . watching the leaves vanish!

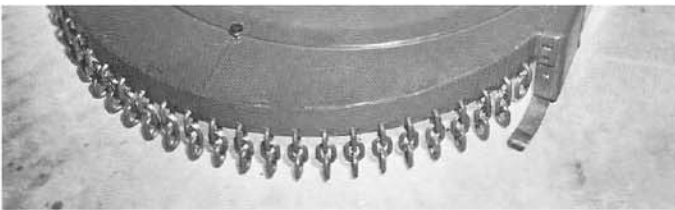

### OPTIONAL CHAIN GUARD

Under certain special conditions, a Gravely Chain Guard may be desirable. Completely encloses front of mower, with a chain curtain to reduce velocity of materials that may be thrown out.

### SPECIFICATIONS

**DRIVE:** Single Drive for Circular, Chain Saw; Rotary Mower and Leaf Mulcher, all interchangeable. Splined Steel Shafts, Bevel Gears, completely enclosed.

**BEARINGS:** Tapered Roller and Ball Bearings.

**ROTARY MOWER:**

**HOOD:** 1/4" Steel. Fenders, 1/8" Steel.

**BLADES:** Two 30-inch Blades of Hi Carbon steel, forged and ground cutting edge.



## COMBINATION SAWING TOOL Clear Land, Cut Timber

Both the Chain Saw and the Circular Saw of this powerful combination tool operate from the same power take off (or "drive"). In addition, the power take-off also operates the Gravely Rotary Mower and Leaf Mulcher.

When you purchase the "drive" for any of these three tools, your additional investment in the other tools is very small!

### CHAIN SAW

A heavy-duty, self-propelled chain saw for felling and bucking timber. Goes to the job under its own power—and you stand upright and comfortable to saw!

The saw is adjustable to any angle vertically or horizontally. It will notch, fell and cut up timber quickly and conveniently. Usually you can fell a large tree in less than three minutes, including positioning the tractor and setting saw angles!

### CIRCULAR SAW

The 18-inch blade of the Circular Saw slashes saplings, small trees, weeds and sprouts off at ground level. You can then mow over the area to keep it cleared.

The Circular Saw, like the Chain Saw, can be set at any angle.

### SPECIFICATIONS

#### CHAIN SAW:

**CHAIN:** Oregon Clipper Chain, Fast File Tooth.

**CHAIN BAR:** Special Tempered Alloy Steel. 1 1/2" maximum width. Length from stop to end of bar, 24". Optional Length bars and chains on request.

**CHAIN SPROCKET:** Carburized Steel.

#### CIRCULAR SAW:

**TEETH:** Cordwood Set.  
**BLADE DIAMETER:** 18 inches.





# SICKLE MOWING - GRAVELY FOR T

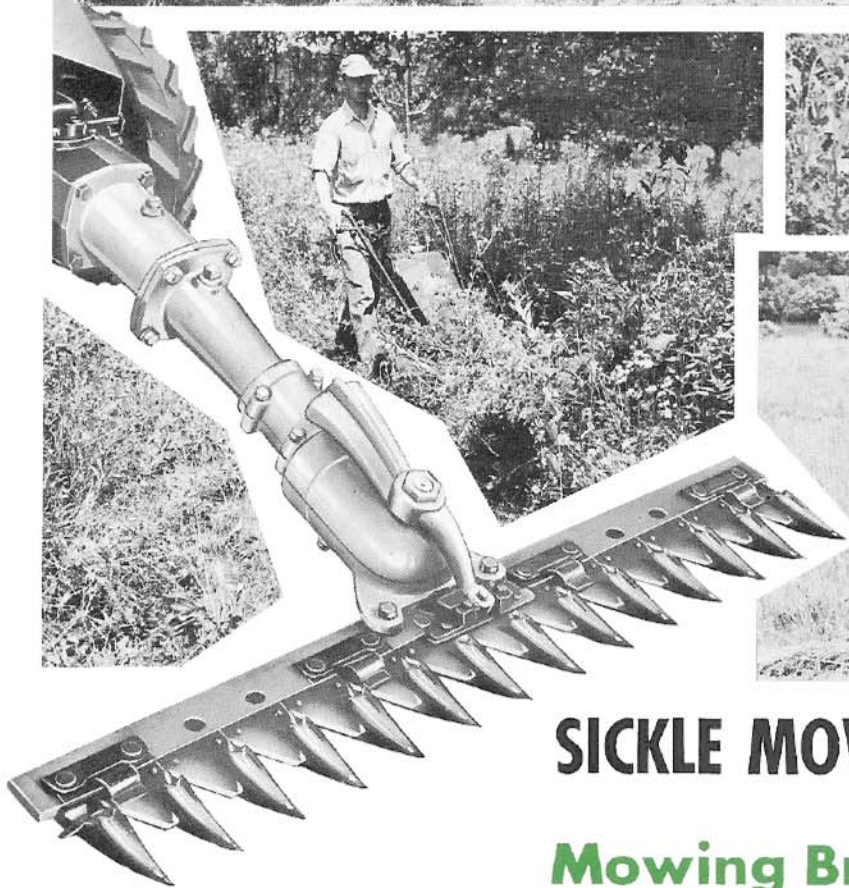
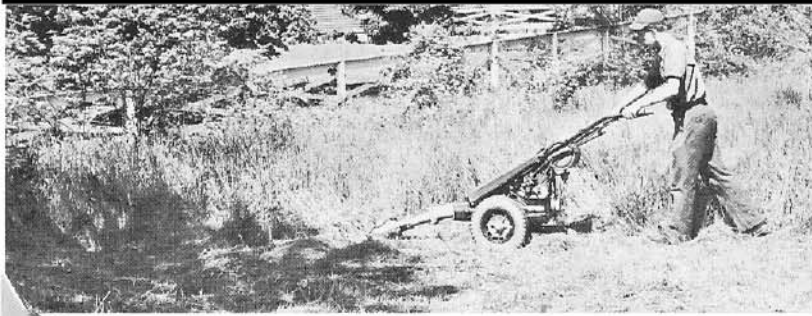

## SICKLE MOWING

### Mowing Brush, Field and Lawn

The Gravely with its Sickle Mower Attachment mows tall grass, even weeds and brush as much as three-quarters of an inch thick!

The Gravely Sickle Mower is without equal because it is DESIGNED for heavy duty cutting. Gear and splined steel shafts drive the mower direct from the powerful Gravely engine — deliver that EXTRA power you must have for the tough jobs!

#### BETTER MOWING WITH SWIVEL ACTION

Yes, better mowing because the unique, patented Gravely Swivel Action allows the Sickle Blade to follow the contour of the ground regardless of the position of the tractor wheels. This makes power mowing of banks, terraces, and rough land

practical when you would ordinarily expect to do these jobs by hand.

#### POWER REVERSE

You can take your mower under trees and shrubs, into hedge rows and corners, then by simply moving a lever the Gravely will back out under its own power. Many hand cutting jobs are eliminated because your Gravely Sickle Mower is so easily maneuvered in these close places.

#### PLENTY OF POWER

You must have power to spare to do this heavy work. The big 6.6 H.P. Gravely engine gives you that power, delivered directly from the motor to the cutting blade. No belts or chains to slip, wear or break—instead you get power to spare for all your difficult mowing jobs!



# THE TOUGHEST MOWING JOBS

## STEEP SLOPES MOWED EASILY

When your Tractor is equipped with either Dual Wheels or Extension Axles you mow slopes as steep as 60%. Either of these accessories lowers the center of gravity of the Tractor, and adds weight which gives more traction. You can mow almost anywhere a man can walk!

## SAFETY CLUTCH PROTECTION

If you should happen to run onto an iron stake, or any other obstruction, the Gravelly Safety Clutch will stall the mower without damage.



## 48" HAY RAKE

After the high weeds and grass are cut, attach the 48 inch Hay Rake and clean up. The Hay Rake is equipped with a comfortable riding seat. The Rake Lever and tractor controls are within easy reach.

## SICKLE MOWER SPECIFICATIONS

**SICKLE BAR:** This consists of a conventional Sickle Bar with an oscillating mechanism. The drive Head is located on the cutter bar for balance; has swivel action, allowing the bar to conform to the contour of the ground independent of the tractor.

**GEARS:** All gears enclosed in dirt-proof housings with Timken Roller Bearings and running in oil.

**CASTINGS:** All vital parts of the oscillating mechanism are made from chrome alloy steel with certified, malleable castings.

**CUTTER BAR:** The 42" Cutter Bar will cut from a 36" to a 39" swath and average from 3 to 4 acres a day in the roughest sort of cutting.

**WEIGHT:** 100 pounds. When packed, 150 pounds.

**OVERALL DIMENSIONS:** 42" x 42".

## BLADE SWIVELS TO FOLLOW CONTOUR

The exclusive Gravelly Patented Swivel Action of the Sickle Mower allows the Cutter Bar to follow the contour of the ground . . . regardless of the position of the tractor wheels.

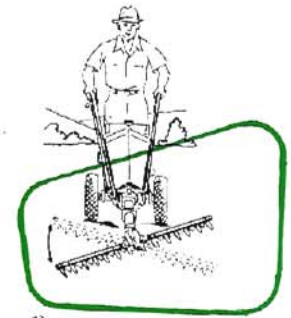

## EXTENSION AXLES FOR STEEP SLOPES

The 35-inch Extension Axles will allow the Gravelly to work on the banks with as much as a 60% angle. These Extension Axles are easily removed, quickly attached.



## DUAL WHEELS ADD TRACTION

Dual Wheels allow you to mow on steep slopes, give you better traction anywhere. They lower the center of gravity, give you twice the traction, and add weight for a better grip on the ground. Especially helpful on rough ground.

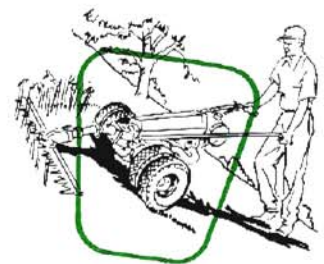

## EASY TO MOW UNDER TREES

The long "neck" of the Sickle Mower mounted on the front of the Tractor allows you to reach under trees, shrubs, bushes, hedges—the reverse allows you to back out quickly and effortlessly.

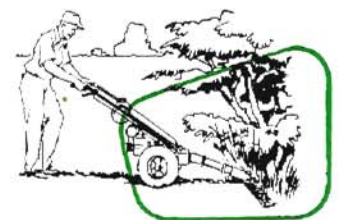

Sharpens six sections of a Sickle Mower Knife before reclamping. It only takes a few minutes to sharpen the complete knife, and sharp knives mean quicker and better work.

Shown below are the two sickle bars—top, the 2-inch Sickle Bar used for lawns and fine cutting. Bottom, the 3-inch Sickle Bar, used for high weeds, heavy cutting of all kinds. Same rugged construction, the only difference is in the size of guards and sections.

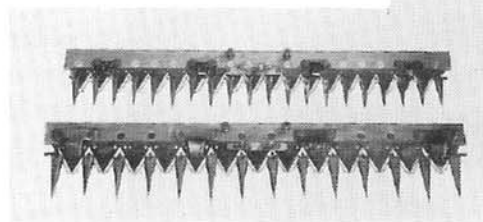
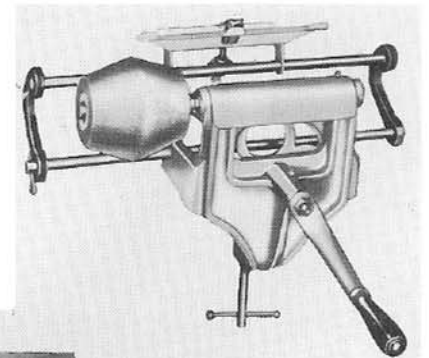



# RIDING SULKIES: STEERING-STANDARD



## STEERING SULKY

The Steering Sulky is used primarily with the Gang Mowers. It gives you easy operation, precision and control.

It is also possible to use the Steering Sulky with other mowing attachments, although a demonstration is advised.

Industrial Users have also found the Steering Sulky a valuable tool in handling the Snowplow and Snowblower. Under most conditions, it may also be used with the New Power Spreader for better control and easier operation.

Heavy duty castings and welded elements, plus pneumatic tires, a comfortable seat.

Dual Wheels and Rear Hitch are required.



## STANDARD SULKY

The Riding Sulky may be used with any Gravely mowing Attachment. With it you enjoy the comfort and convenience of riding while you mow—get more work done in less time. You don't get tired mowing—there are fewer stops to rest, so you get the job done fast!

Steering is done by pressure on the handles. The Sulky trails the tractor, and excellent control for close work is obtained.

The Riding Sulky's low cost and advantages of speed, ease and convenience in mowing have made it one of our most popular attachments. It is sturdily constructed of welded elements for long service, equipped with a comfortable seat and pneumatic tires. Rear Hitch is required.

## PROTECT YOUR INVESTMENT IN YOUR LAWN!



## LAWN ROLLER

You want a velvet-smooth lawn—and the Gravely Water Ballast Roller will help you. The Roller levels your lawn, takes out unsightly humps and depressions. And more important still, the compacting of the soil will give you a close-knit, firmly rooted lawn, resistant to disease, weeds and drouth. The Roller will follow the contour of the ground. The edges are rounded to prevent cutting or injury to your lawn. You have plenty of power with the Gravely Tractor to pull this load, and you will find that the Roller does a fast and efficient job. The roller is 32" wide, weighs 655 pounds when loaded. *Particularly useful for rolling down Frost and Freeze damage.*



# HAULING CART



**HAULS ½ TON LOADS WITH EASE!**

You always need a Transportation Cart to do odd jobs of hauling. A thousand pound load of apples, wood, hay, alfalfa, feed, or other material can be handled with this sturdy, self-dumping cart. The body is wood, reinforced by steel. Merely releasing a latch dumps the cart with no effort. The body may be removed and special racks attached for hauling hay, alfalfa and other bulky crops. The body is 48 inches long by 30 inches wide by 11½ inches deep. The Cart is equipped with pneumatic tires, roller bearing wheels, and a seat.



## POWER BARROW

Now you haul sand, cement gravel, other heavy loads quickly, safely. The Power Barrow handles up to five cubic feet of material, dumps easily by raising the handle; locks down for safety.

When you use the Gravelly Power Barrow, the powerful Gravelly moves the heavy loads . . . all you do is guide it!

Steel and cast-iron construction, Roller Bearing Caster Wheel. Can be used with Starter, with a special inexpensive Side-Mount for the Battery.

## DUAL WHEELS

The Dual Wheels are required when using the Gravelly Steering Sulky for best results, and should always be used when using the tractor on steep slopes.

The Dual Wheels are quick and easy to install. They double your traction surface, add weight. They consist of Tractor Tires and Tubes, Rims, and the Dual Wheel spacers and necessary attaching bolts.



## GEAR REDUCTION WHEELS

You can have an even more powerful Tractor by using Geared Wheels. The Gear Reduction ratio in the wheel (3 to 1) gives the same effect as an extra low gear. The engine speed stays the same but the ground speed is only one-half as fast. The extra weight—65 pounds per wheel—gives you considerably more traction. These wheels will enable you to do a much better job of heavy work, especially with the Rotary Plow in hard soil. The wheels give nine-inch maximum ground clearance under the tractor. Tires are 20" in diameter.





# SNOWBLOWER - *GRAVELY* POWER

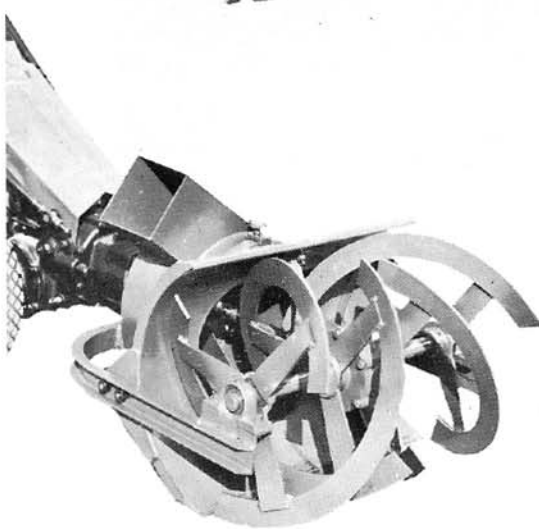

## **MOVE THE SNOW—FAST!**

Why endure the misery and freezing-cold, the hard and exasperating work of hand shoveling snow? The Gravelly does the job quickly, almost without effort! Instead of hours spent in hard work, a few minutes behind your Gravelly and your sidewalk and drive are snow free. You can get going without the delay and uncertainties of waiting for someone to dig you out — protect yourself and your family from the danger and inconvenience of snow-clogged walks and drives.

## **Only Gravelly Gives you a Choice of Three Snow Removal Tools!**

Remember this important fact when you consider snow removal equipment. Only Gravelly offers you **THREE** attachments—the power-driven Snowblower, the Blade Type Snow Plow, and the power-driven Rotary Brush. Only Gravelly has the complete answer to your snow removal problem! Because these three tools—singly or in combination—can handle any snow removal situation where small power equipment is used.

Another vital fact: Only the Gravelly Tractor has the power to handle the work these attachments perform! Snow removal is heavy work—it takes plenty of dependable power, good traction, and tools that are specifically designed for the job.

The Gravelly has proved its worth by the many users in Industry, Cities, Schools, Hospitals. You can't go wrong with the time-tested Gravelly snow removal equipment.



# DOES THE WORK - SNOWPLOW

## SNOW BLOWER

A few minutes with your Gravely Snowblower, and your snow troubles are blown away!

The Snowblower handles snow up to four feet deep, hard-packed or powdery. Picks it up, throws it as much as thirty feet, right or left, at any angle! Don't worry if other snows come while the first ones are still banked beside your walk or drive—the Snowblower puts the snow over the top of the deepest drift.

The heavy reel, gear-driven, cuts into snow crust and ice, breaking it into pieces and actually pulling the snow into the heavy duty gear-driven fan. There are no belts or chains to freeze, slip or wear on the Gravely Snowblower—it is all-gear, fully enclosed drive!

The Snowblower will remove snow from almost any surface efficiently. The Snowblower is equipped with runners to reduce the possibility of picking up loose stones and gravel when working on bluestone or gravel walks or drives. When blowing snow on macadam or concrete, removing the runners will give you a clean sweep of snow down to the surface.

Geared wheels are recommended for moving deep, heavy snows.

## BLADE TYPE SNOW PLOW

The Snow Plow attachment is 48 inches wide. The usual width driveway is cleared in two sweeps, the sidewalk in one. The plow will handle snow up to 14 inches deep. It moves more snow better because the blade is scientifically designed to roll the snow out of the way instead of pushing it. The angle of the plow is instantly changed by only one pin adjustment. It may be set to throw snow to the left, right, or straight ahead. The wearing edge is of carbon steel, renewable—you will never wear out our plow blade. Extra heavy construction, built for the rugged snow removal jobs!

The Snow Plow attachment is a good tool for efficient and economical light landscaping. You bulldoze loose dirt, poultry litter, and similar materials. Best results will be obtained by using Dual Wheels, Chains or Gear Reduction Wheels to give the Tractor sufficient traction for a heavy job.

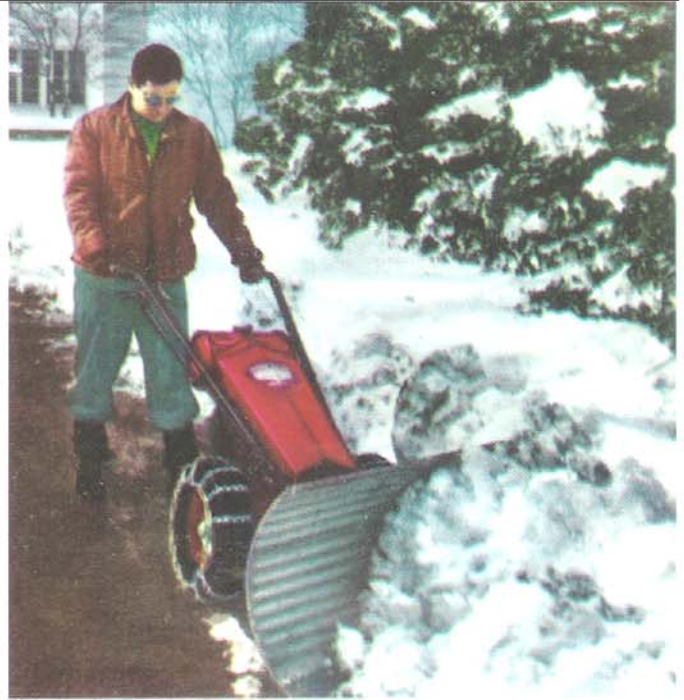

### SPECIFICATIONS

#### SNOWBLOWER

BLADE: 25 $\frac{3}{4}$ " wide, 12 Gauge (.109") Carbon Steel.  
REEL: 18 $\frac{1}{2}$ " diameter,  $\frac{1}{4}$ " Carbon Steel, welded.  
FAN: Blades  $\frac{5}{8}$ " Carbon Steel. Fan Disc .109" Carbon Steel. Hub machined alloy Steel.  
CASTINGS: Malleable Iron.  
GEARS: Bevel Gears, machine cut from Pearlite Malleable Iron.  
BEARINGS: Roller and Ball Bearings, with Reel Shaft running on Pillow Block Bearings.  
FRAME:  $\frac{1}{2}$ " Channel, 1" x 2" Welded supports.  
DRIVESHAFTS: Cold Rolled Steel.

#### SNOW PLOW

BLADE:  $\frac{1}{4}$ " Carbon Steel.  
WEARING STRIP:  $\frac{1}{4}$ " Carbon Steel.  
CASTINGS: Malleable and Grey Iron.

"My driveway is about 150' long with a turning area. Last spring I had one of those coronary thrombosis affairs and either had to get something to lighten my chores, or sell and get a smaller place which I wouldn't want to do.  
"Now I can clean out our driveway in twenty minutes or less with practically no effort where it used to take hours of shoveling. By actual timing I cleaned 165' of straight driveway of about 8" of snow in ten minutes flat for an old neighbor!  
"If anyone wants to know what a user of your snowblower thinks of it, refer them to me."

Yours truly,

RAYMOND S. CARTER  
RD No. 1, Escarpment Dr.  
Lewiston, New York



# POWER SPREADER

# POWER BRUSH



## Get Rid of Ice—QUICK!

Icy, dangerous areas are now made SAFE quickly and efficiently, with the new Gravely self-propelled, power-driven Power Spreader.

The Spreader handles Salt, Sand, Calcium Chloride, Granular Fertilizer, Pelletized Feed. Spread is from 4 feet minimum to 15 feet maximum, when using the standard mix of salt and sand.

Controls are at the Operator's fingertips for top efficiency. Spread is controlled while moving, narrowing or widening as required. Feed of the material is controlled by a lever, within easy reach of the operator.

The Spreader handles a maximum of 1,500 pounds of material. Approximate spread area, 15 feet wide by 1,050 feet in one loading.

In addition to removing ice hazards, the Spreader will fertilize. It is also useful, with Calcium Chloride, as an efficient spreader to reduce dust on roads, construction projects, etc.

## Sweep Snow, Debris, Away!

Home owners with long drives and walks, Industries with outside docks, drives and walks find the Power Brush very useful in sweeping snow and cleaning up. Large lawn areas are kept clean with the Power Brush removing debris and dead grasses.

You can sweep faster than you can shovel . . . for light snows, the 38" sweeping width of the Power Brush means a fast clean-up job before the snow has a chance to melt and freeze. It will sweep *clean* the first time over!

Available with either fine or coarse bristles, to suit your job. Interchangeable on the carrying shaft for maximum wear.

There is an easy brush-to-surface pressure adjustment. A single lever lifts the Brush from contact level for transportation.

Industry uses it widely for roofing jobs, snow removal, general sweeping. Whether it is dirt, litter or light snow, the Gravely Power Brush sweeps *clean* and *fast* the first time over!

### POWER SPREADER—SPECIFICATIONS—POWER BRUSH

**DIMENSIONS:** 36" Wide, 48" Long, 35" High.

**HOPPER CAPACITY:** 11 cu. ft. 1500 lbs. sand, 600 lbs. Salt, Calcium Chloride, Granular Fertilizer or Lime.

**CARRIAGE:** 3/16" Structural Steel Framing, welded. Floating Axle, Dual Tire bolts to Wheel.

**HOPPER:** 16 Ga. reinforced Steel. Equipped with power vibrator, ports and flaps (one each side) operator controlled.

**DRIVE:** REQUIRES ROTARY MOWER DRIVE.

**CASTERS:** Heavy-Duty, Timken Bearings.

**GUARD:** 18 Gauge Steel

**HOUSINGS:** Grey Iron or Meehanite

**DRIVE:** Cold-rolled steel shafts

**BEARINGS:** Tapered Roller and Ball Bearings

**SPROCKETS:** Carbon Steel, hardened teeth

**DIMENSIONS:**

Overall Width: 47½" Overall Height: 18"

Overall Length: 30" (Tractor to edge of brush segment)

Brush Diameter: 14"

**CASTER WHEELS:** 5" Diameter

**BRUSH STRIPS:** Fine or Coarse Bristle. Replaceable.



# ACCESSORIES & OPTIONAL EQUIPMENT

## STARTER

A completely new experience in push-button power is yours with the Gravely Electric Starter.

Now practically all the work is taken from upkeep and gardening jobs. Just touch your toe to power and you are ready for the toughest jobs!

The Gravely Starter is inexpensive. Weight is balanced perfectly to your tractor. Installation is simple and easy.

With an improved 21-cam over-running clutch, the Gravely Starter is long-lasting and dependable. Think of the advantage of just pushing the button—in any weather, at any time—and instantly the powerful Gravely is ready to take the drudgery from your country living!

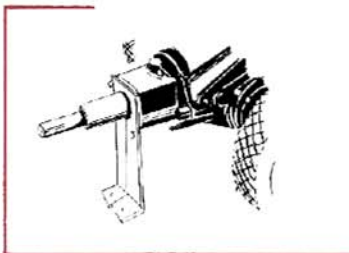
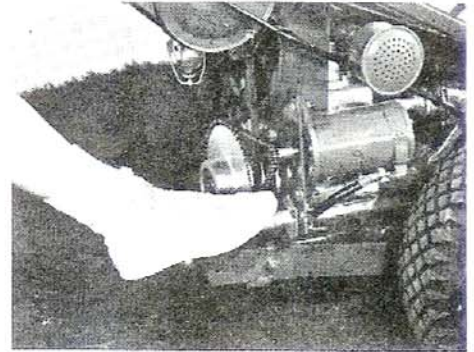

### POWER TAKE-OFF

You drive most belt-driven machinery found on the average country home or farm. The Attachment can be bolted to the floor, and the tractor run up to it when power is desired.

The Power Take-Off is required for many Use-Multiplier Attachments. Any standard pulley up to 20" may be used.

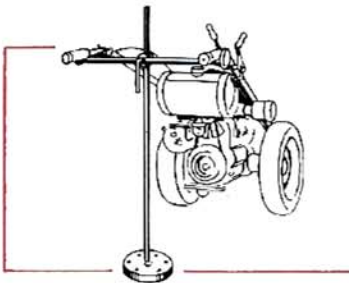

### TRACTOR STAND

An inexpensive Tractor Stand makes changing Attachments easy. Quickly adjusted to the correct height and locked firmly, it allows you to attach your equipment with new ease and speed, holding the Tractor securely at just the right height.

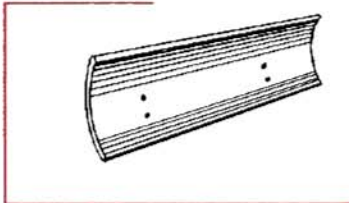

### SCRAPER BLADE

This small, inexpensive scraper blade is ideal for many small scraping and leveling jobs. Rolled blade design moves loose dirt, gravel, cinders easily. Attaches to your Gravely Toolholder. 36" wide, 8½" high.



### OIL PRESSURE GAUGE

Now you can check your oil pressure at a glance! Quickly and easily installed, the Gravely Oil Pressure Gauge makes it fast and easy to check your oil pressure.

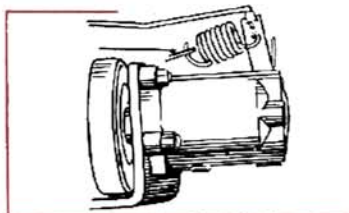

### GOVERNOR

Using a Gravely Governor gives you amazing ease and convenience. The Governor regulates the fuel to the job automatically. You save fuel and wear on your engine with this Governor protection.



### ATTACHMENT CLUTCH CONTROL

An optional Attachment Clutch Control allows you to put the Attachment in or out of gear from the Handle. The price is low—the convenience great. Installed in minutes.

### TIRE CHAINS

Tire chains will give you added traction in snow, ice, loose soil. Manufactured especially for the Gravely, the chains are easily installed, will give you years of service.



### SULKY, SEAT CUSHION

A soft, foam rubber cushion that makes your Riding Sulky even more comfortable. With a heavy duty plastic cover and tie-strings, the cushion floats you on air as you do your mowing.

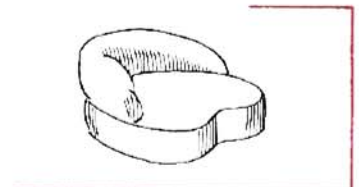

### TRACTOR COVER

Contoured to fit your Tractor, of heavy, mildew-proof water-proof reinforced duck, the Gravely Tractor Cover will protect your equipment from the weather. A must when Gravely equipment is stored outdoors.





# USE - MULTIPLIER ATTACHMENTS



## SEEDER-SPREADER

Ride comfortably on this big, 5' Seeder-Spreader, while you make your seeding and spreading jobs fast and easy!

Even, accurate control for seed, lime or fertilizer. 300 pound capacity hopper with positive action gate, and an application control guide and handle that makes accurate seeding or spreading simple—just set it and forget it!

Ideal for lawn feeding, small farm fertilizing, golf course, city, school and industrial seeding and spreading, the Seeder-Spreader will soon pay for itself in efficient spreading, better control of seed and fertilizer—and time!



## HOME 'N-GARDEN SPRAYER

Get rid of insects, weeds, fungus quickly and easily . . . protect your investment in your lawn, garden, shrubs and trees. Old-fashioned hand and carry sprayers take too long to do the job—and are too much work! The 15 gallon capacity Home'n-Garden Sprayer, powered by the Gravelly Tractor, will handle corrosive and abrasive sprays, all routine spraying jobs besides doing fly, mosquito and weed-control jobs efficiently.

No lifting, carrying or pushing—the Sprayer and Tractor goes to the job with nothing but a guiding hand. Slender as a Gravelly, goes easily down garden rows, through gates and doors.

Optional boom attachment for lawn and garden spraying, applying liquid fertilizers. Help yourself to an abundant harvest, pest free lawn, garden, flowers and trees with this inexpensive, efficient sprayer! Sprays 3 GPM at 300 lbs. pressure. Power Take-Off Required.

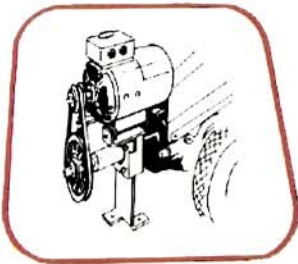

## GENERATOR

1500 Watt Generator for emergency power. Complete with bracket. Gravelly Power Take Off required.



## PUMP

Low pressure, high capacity pump for volume pumping of liquids. Complete with bracket. Gravelly Power Take Off required.

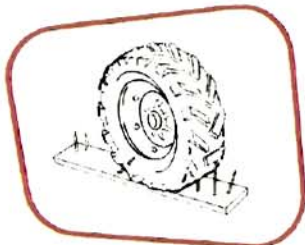

## SEMI-PNEUMATIC TIRES

No more punctures. Special semi-pneumatic tires never go flat. One inch wider for more traction surface. Ground grip tread only.



## BLITZ-FOGGER

Gets rid of insects, mosquitos, fast. Puts out a cloud of fog which kills insects on contact, harmless to human beings. Complete with 1 qt. Thermaline fog.

# ASK FOR "USE-MULTIPLIER" FOLDER — FREE!



# WORLDWIDE SALES AND SERVICE



DEALER



PARTS

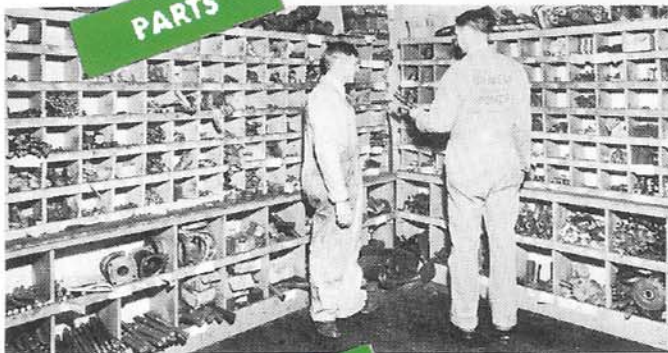

SERVICE



## A Specialized Organization To Serve You Best

On this page are illustrated the four main features of the world-wide Gravelly sales and service organization. The Company-owned Station sells and services retail in its own area, and supplies its Dealers with equipment and parts. The Dealers are independent business men, most of whom do nothing but sell and service Gravelly Equipment. You will find this same organization not only in the U.S.A. but in Canada and most foreign lands.

## Special Tools Trained Mechanics

Both the Dealer and Station have tooled their shops to render the most efficient service on the Gravelly. Their mechanics are trained in factory methods. They stock Gravelly repair parts at all times. Their service is fast and efficient, therefore it costs you less and serves you better.

## Buy With Confidence

You buy the Gravelly with confidence—this world-wide organization could only have been built by consistently providing an excellent product and dependable service to our Gravelly users!



# HERE'S WHY **GRAVELY** IS



## Built To Out-Perform All Others

The next page shows you many exclusive mechanical features. But individual features are not what you buy.

You buy *performance*—the whole Gravelly Tractor. Put all these mechanical features together and you have the finest tractor money can buy. You have a tractor that will outperform any other tractor.

### SEE FOR YOURSELF!

Until you actually get behind a Gravelly, until you see and feel for yourself the amazing power and versatility of the Gravelly, you will have no conception of what **POWER** upkeep and **POWER** gardening really mean.

When you use your Gravelly and see your work done faultlessly . . . when you suddenly realize what a wonderful job you have done with such amazing speed and ease . . . then you realize that the Gravelly is *your* tractor.

Only then can you know the absolute, complete satisfaction that comes to you when you have bought the best—and proved it by job test.

The Gravelly has integrated design, with 35 years of specialized experience in manufacturing Gravelly equipment. The next page shows you some of the many exclusive features that have helped build the Gravelly reputation to that of the acknowledged leader in its field.

With all these features, you still buy the Gravelly at a price that compares favorably with many other makes with less horsepower, less performance at the job!

### SATISFACTION

And remember this. The price you pay for the Gravelly will soon be forgotten. But the satisfaction of using the best, of investing your money wisely, of getting your work done in the best possible way . . . that satisfaction is yours for *years*. Because Gravelly is a lifetime investment in power for your jobs! Invest in the best—Gravelly!

### GROUND SPEED OF YOUR CHOICE

Now you can buy a Gravelly Tractor with the ground speed of your choice, to suit your pace, your job. Three models are available, and your Gravelly Dealer will suggest the one best suited to your particular needs. Below is a table giving the ground speeds available with the three models.

**TABLE OF MAXIMUM GROUND SPEEDS FOR ALL MODELS**

LS GRAVELLY	LI GRAVELLY	L GRAVELLY
High Gear: 2 mph	High Gear: 3 mph	High Gear: 4 mph
Low Gear: 1½ mph	Low Gear: 2¼ mph	Low Gear: 3 mph



# YOUR BEST BUY

## Practical, Quality Design

This cutaway view shows the completely functional design of the Gravelly . . . the motor, chassis and attachment flowing cleanly and simply into one compact, precision machine.

Each part of the Gravelly is designed to be used with the other — not merely assembled. The Gravelly uses the same type of drive and transmission as an automobile for dependable power.

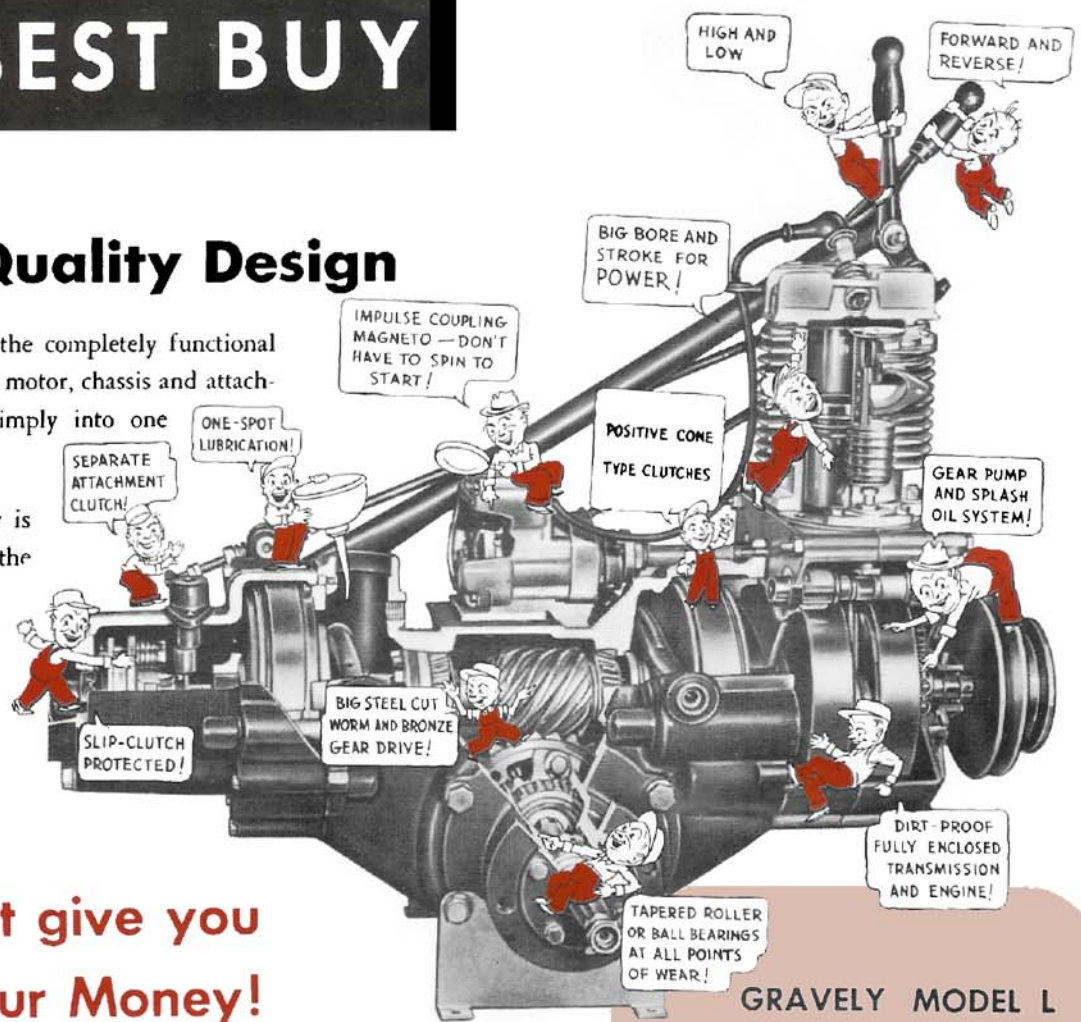

## Features that give you More for your Money!

**Power!** The Gravelly engine is conservatively rated at 6.6 HP. Its large bore and stroke at a comparatively low piston speed means dependable power for the toughest jobs. Power is transmitted to the job through gears and splined steel shafts — no belts or chains to slip or wear!

**Precision Made** in two modern factories devoted exclusively to the manufacture of Gravelly products.

**Safety Clutch Protected.** Every Gravelly power attachment is protected against shock damage by a special Gravelly Safety Clutch. This clutch dissipates the shock and stalls the tractor without damage to either attachment or tractor. The Clutch transmits the full power of the engine . . . but saves your equipment from breakage and damage when you strike an obstacle.

**Attachments Power-Designed** to put the power to the job. Gravelly is unique because each attachment is designed as an integral part of the tractor, to give the maximum performance at the job.

**Unique Swivel Action.** Only the Gravelly gives you complete Swivel Action. The attachments follow the contour of the ground, regardless of the position of the Tractor Wheels.

### GRAVELLY MODEL L TRACTOR SPECIFICATIONS

**MOTOR:** Gravelly (own make) one-cylinder 4-stroke, T-head type with removable head. Air-cooled by motor driven fan.  
**BORE:** 3¼ inches. **STROKE:** 3½ inches.  
**RINGS:** One Oil Ring, 2 Compression Rings, Top Ring Chromed.  
**VALVES:** Mechanical. **CARBURETOR:** Zenith, Gravelly Special.  
**OILING SYSTEM:** Gear pump and Splash, full-flow oil filter, high-pressure—high volume system. Filtered oil under pressure to connecting rod and drive shaft bearings.  
**MAGNETO:** Impulse Type. Brand: Wico.  
**OIL FILTER:** WIX Full-flow.  
**AIR CLEANER:** Oil Bath. Brand: United Specialty.  
**BEARINGS:** Tapered Roller or Precision Ball Bearings at all important points.  
**HORSEPOWER:** 6.6 Horsepower at 2600 RPM.  
**TRANSMISSION:** Transmission and Timing Gears Alloyed Iron and hardened steel. Precision Cut Teeth.  
**DIFFERENTIAL:** (Automotive Gear Type) hardened steel cut Bevel Gears, Steel Worm, special alloyed bronze Worm Gear.  
**CLUTCH:** Two double-acting cone-type clutches, one as speed selector, one giving forward and reverse motion. Planetary Gears. Clutch Bands special bonded lining to heavy duty grey iron casting.  
**CLUTCH, SAFETY:** All power attachments individually protected from shock by Safety Clutch, consisting of two Fiber and one Steel Disc enclosed in springloaded driving plates. Disc slip under sudden shock, drive attachment at full Horsepower under load.  
**HEIGHT:** 28 inches (Not including adjustable handles)  
**OVERALL WIDTH:** 24 inches at widest point.  
**LENGTH:** 55 inches (Not including attachments).  
**WEIGHT:** Net, 296 lbs. Crated, 355 lbs. domestic, 410 lbs. export.  
**THROTTLE:** Thumb throttle. Optional Governor (Pierce).  
**GAS TANK CAPACITY:** 1¾ Gallons. **OIL CAPACITY:** 5 Pints.  
**TIRES:** 4.00 x 8, 16" O.D. 2 Ply, Sure-grip or Diamond tread.





## 38 YEARS OF SPECIALIZED EXPERIENCE!

SEE WHAT A GRAVELY  
USER SAYS ABOUT  
HIS PLEASURE IN  
BUYING THE BEST!

Gravelly Tractors  
Dunbar,  
West Virginia

Gentlemen:

I can't imagine how I could get along without my Model L Gravelly equipment. For the past two years I have lived on a ten acre tract of lawn, orchard and wooded land with a large garden, some grapes, berries, etc. Besides several acres of level mowing, there are also quite difficult slopes and grades to maintain, all of which is handled very nicely with your equipment.

There has been no mechanical trouble whatsoever in over a year and a half of use and the machine seems to be as good as new today.

I use both sizes of cutter bar in mowing as well as the cultivating and weeding equipment for garden and vineyard. This work is done by myself out of business hours and I not only enjoy seeing the results but there is actually pleasure in it.

The Gravelly makes possible for me the difference between that of just a house in the country with perhaps only a small lawn and garden and that of a well kept ten acres with an expanse of lawn and all the other areas in good order. My friends wonder how it is done and your Gravelly equipment is really the answer. There should be a very broad market for something so practical as this.

Very truly yours,

*Kenneth Alcock*

KACool/ew

In 1922 the Gravelly Tractor was offered to the world as a novel and practical time-saving invention—a power driven small tractor. Improvements and new models have been added, and the many varied and useful attachments that you have read about have been developed.

Over the years the factory at Dunbar was enlarged. The most modern machinery was installed and re-installed; special machinery designed and put into production. It is a factory devoted exclusively to the making of the Gravelly Tractor, its own motor, and attachments.

In 1957 a second factory was built at Albany, Georgia, for the same purpose.

Each manufacturing operation at both plants is controlled, each machine produced as a complete unit, each part DESIGNED to be used with the other. Not merely assembled, but completely designed and manufactured by the Gravelly Company. You will do best by buying the machine that is time-proved. More than a quarter-century of engineering and manufacturing skill are back of the famous Gravelly Tractor and Attachments.

### FREE DEMONSTRATION

Like our product, our sales policy is better than the usual one. We do not ask you to buy a Gravelly until you have seen what it will do for you on your own ground, under your own conditions. Our Dealers and Distributors are glad to give you the benefit of their experience with power equipment, glad to show you the Gravelly at no obligation.

Ask your Dealer or Distributor for your free demonstration—or write us and we will arrange for a representative to visit you and quote prices on the tools they would recommend for your work.

Request your free demonstration today!

### SOLD BY

**GRAVELY TRACTORS, DUNBAR, WEST VIRGINIA, U. S. A.**