

KOHLER[®]engines

SERVICE MANUAL ***COMMAND 11, 12.5, 14 HP*** ***Horizontal Crankshaft***



COMMAND

CONTENTS

SECTION 1. General Information	1
SECTION 2. Special Tools	2
SECTION 3. Troubleshooting	3
SECTION 4. Air Cleaner And Intake System	4
SECTION 5. Fuel System And Governor	5
SECTION 6. Lubrication System	6
SECTION 7. Retractable Starter	7
SECTION 8. Electrical System And Components	8
SECTION 9. Disassembly	9
SECTION 10. Internal Components	10
SECTION 11. Reassembly	11

SECTION 1 GENERAL INFORMATION

FOR YOUR SAFETY

WARNING: For Your Safety!



This symbol points out important safety Warnings and Cautions throughout this manual. These Warnings and Cautions should be followed at all times. Failure to follow Warnings and Cautions could result in injury to yourself and others nearby.

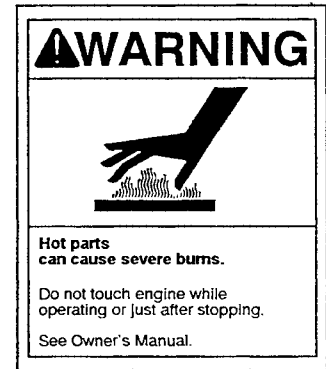
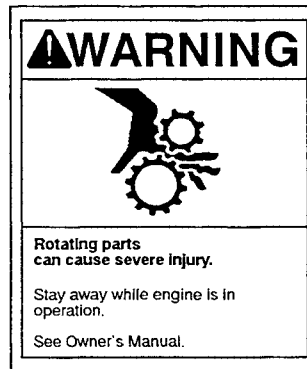
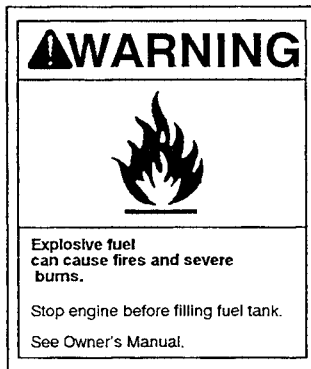

WARNING: Explosive Fuel!



Gasoline is extremely flammable and its vapors can explode if ignited. Store gasoline only in approved containers, in well-ventilated, unoccupied buildings, away from sparks or flames. Do not fill the fuel tank while the engine is hot or running, since spilled fuel could ignite if it comes in contact with hot parts or sparks from ignition. Do not start the engine near spilled fuel. Never use gasoline as a cleaning agent.

WARNING: Rotating Parts!



Keep hands, feet, hair, and clothing away from all moving parts to prevent injury. Never operate the engine with covers, shrouds, or guards removed.

WARNING: Hot Parts!



Engine components can get extremely hot from operation. To prevent severe burns, do not touch these areas while the engine is running—or immediately after it is turned off. Never operate the engine with heat shields or guards removed.

SECTION 1 GENERAL INFORMATION

WARNING: Accidental Starts!



Before servicing the engine or equipment, always disconnect the spark plug lead to prevent the engine from starting accidentally. Ground the lead to prevent sparks that could cause fires. Make sure the equipment is in neutral.

CAUTION: Electrical Shock!



Never touch electrical wires or components while the engine is running. They can be sources of electrical shock.

WARNING: Lethal Exhaust Gases!



Engine exhaust gases contain poisonous carbon monoxide. Carbon monoxide is odorless, colorless, and can cause death if inhaled. Avoid inhaling exhaust fumes, and never run the engine in a closed building or confined area.

WARNING: Overspeed Is Hazardous!



Do not tamper with the governor setting. Overspeed is hazardous and could cause personal injury.

WARNING: Dangerous Acid, Explosive Gases!



Batteries contain sulfuric acid. To prevent acid burns, avoid contact with skin, eyes, and clothing. Batteries produce explosive hydrogen gas while being charged. To prevent a fire or explosion, charge batteries only in well ventilated areas. Keep sparks, open flames, and other sources of ignition away from the battery at all times. Keep batteries out of the reach of children. Remove all jewelry when servicing batteries.

Before disconnecting the negative (-) ground cable, make sure all switches are OFF. If ON, a spark will occur at the ground cable terminal which could cause an explosion if hydrogen gas or gasoline vapors are present.

WARNING: Flammable Solvents!



Carburetor cleaners and solvents are extremely flammable. Keep sparks, flames, and other sources of ignition away from the area. Follow the cleaner manufacturer's warnings and instructions on its proper and safe use. Never use gasoline as a cleaning agent.

WARNING: Spring Under Tension!



Retractable starters contain a powerful, flat wire recoil spring that is under tension. Do not remove the center screw from the starter until the spring tension is released. Removing the center screw before releasing spring tension, or improper starter disassembly, can cause the sudden and potentially dangerous release of the spring.

Always wear safety goggles when servicing retractable starters—full face protection is recommended.

To ensure personal safety and proper starter disassembly and reassembly, follow the procedures in this section carefully.

ENGINE IDENTIFICATION NUMBERS

When ordering parts, or in any communication involving an engine, always give the **Model, Specification, and Serial Numbers** of the engine. Include letter suffixes, if there are any.

The engine identification numbers appear on decal (or decals) affixed to the engine shrouding. See Figure 1-1. The significance of these numbers is shown in Figure 1-2.

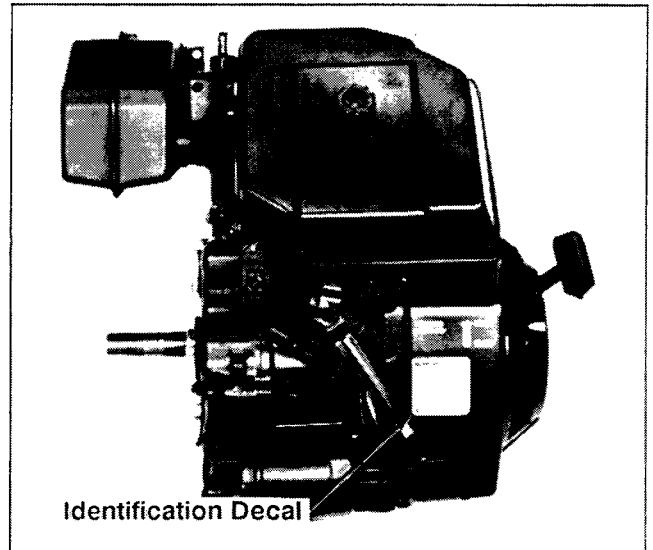

Figure 1-1. Engine Identification Plate Location.

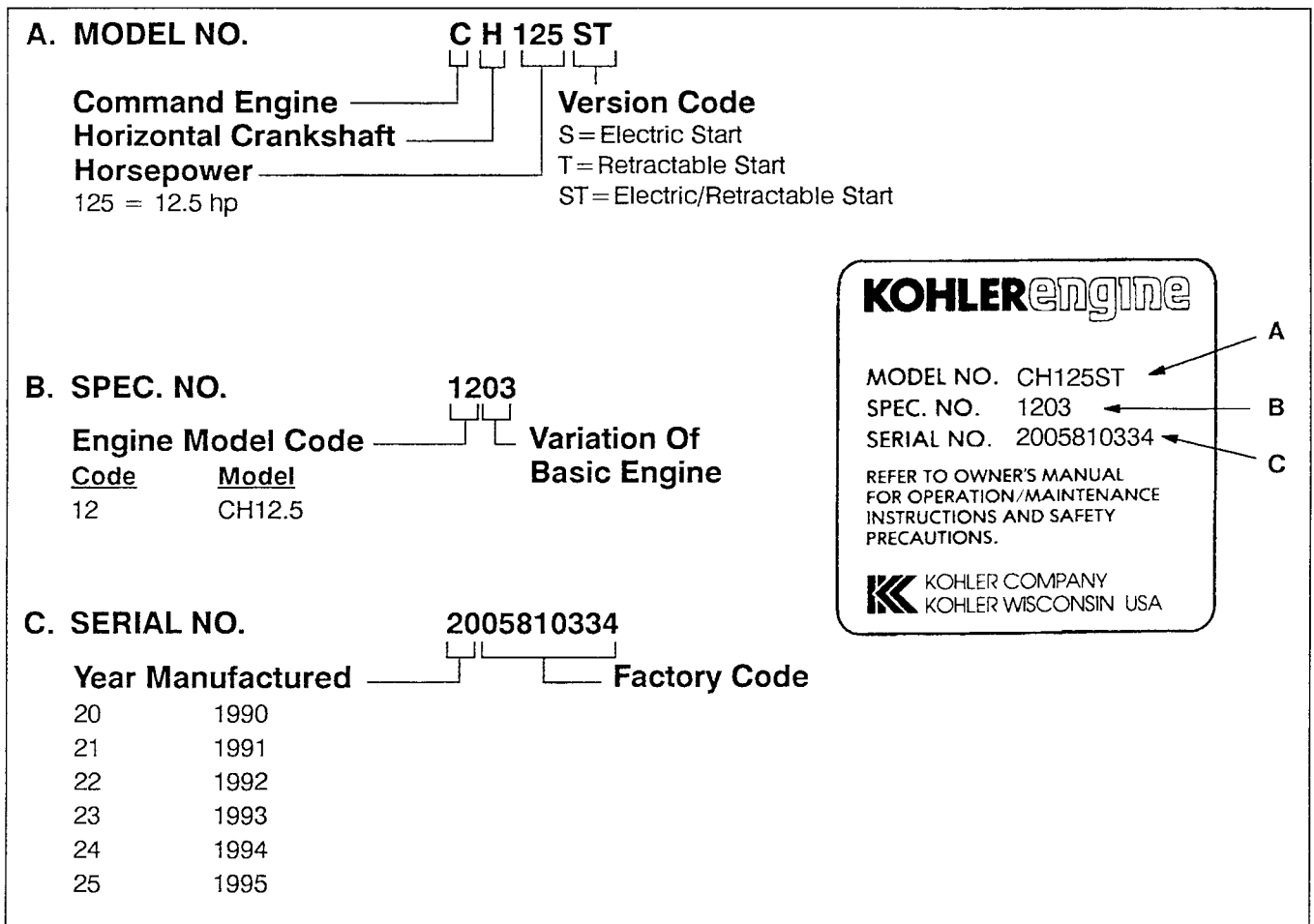

Figure 1-2. Significance Of Engine Identification Numbers.

SECTION 1

GENERAL INFORMATION

OIL RECOMMENDATIONS

Using the proper type and weight of oil in the crankcase is extremely important. So is checking oil daily and changing oil regularly. Failure to use the correct oil, or using dirty oil, causes premature engine wear and failure.

Oil Type

Use high-quality detergent oil of **API (American Petroleum Institute) service class SF, or SG**. Select the viscosity based on the air temperature at the time of operation as shown in the following table.

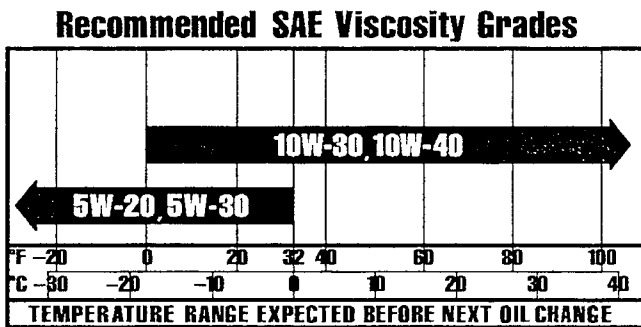

NOTE: Using other than service class SF or SG oil or extending oil change intervals longer than recommended can cause engine damage.

A logo or symbol on oil containers identifies the API service class and SAE viscosity grade. See Figure 1-3.

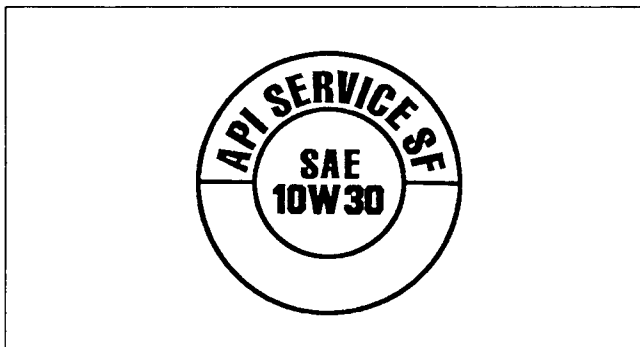

Figure 1-3. Oil Container Logo.

Refer to Section 6 – “Lubrication System” for detailed oil check, oil change, and oil filter change procedures.

FUEL RECOMMENDATIONS



Explosive Fuel!

Gasoline is extremely flammable and its vapors can explode if ignited. Store gasoline only in approved containers, in well-ventilated, unoccupied buildings, away from sparks or flames. Do not fill the fuel tank while the engine is hot or running, since spilled fuel could ignite if it comes in contact with hot parts or sparks from ignition. Do not start the engine near spilled fuel. Never use gasoline as a cleaning agent.

General Recommendations

Purchase gasoline in small quantities and store in clean, approved containers. A container with a capacity of 2 gallons or less with a pouring spout is recommended. Such a container is easier to handle and helps eliminate spoilage during refueling.

Do not use gasoline left over from the previous season, to minimize gum deposits in your fuel system and to insure easy starting.

Do not add oil to the gasoline.

Do not overfill the fuel tank. Leave room for the fuel to expand.

Fuel Type

For best results, use only clean, fresh, unleaded gasoline with a pump sticker octane rating of 87 or higher. In countries using the Research method, it should be 90 octane minimum.

Unleaded gasoline is recommended, as it leaves less combustion chamber deposits. Leaded gasoline may be used in areas where unleaded is not available and exhaust emissions are not regulated. Be aware however, that the cylinder head will require more frequent service.

Gasoline/Alcohol blends

Gasohol (up to 10% ethyl alcohol, 90% unleaded gasoline by volume) is approved as a fuel for Kohler engines. Other gasoline/alcohol blends are not approved.

Gasoline/Ether blends

Methyl Tertiary Butyl Ether (MTBE) and unleaded gasoline blends (up to a maximum of 15% MTBE by volume) are approved as a fuel for Kohler engines. Other gasoline/ether blends are not approved.

PERIODIC MAINTENANCE

WARNING: Accidental Starts!



Before servicing the engine or equipment, always disconnect the spark plug lead to prevent the engine from starting accidentally. Ground the lead to prevent sparks that could cause fires.

Maintenance Schedule

These required maintenance procedures should be performed at the frequency stated in the table. They should also be included as part of any seasonal tune-up.

FREQUENCY	MAINTENANCE REQUIRED	REFER TO:
Daily Or Before Starting Engine	Fill fuel tank. Check oil level. Check air cleaner for dirty ¹ , loose, or damaged parts. Check air intake and cooling areas, clean as necessary ¹ .	SECTION 5 SECTION 6 SECTION 4 SECTION 4
Every 25 Hours	Service precleaner element ¹ .	SECTION 4
Every 100 Hours	Service air cleaner element ¹ . Change oil. Check spark plug condition and gap. Remove cooling shrouds and clean cooling areas ¹ .	SECTION 4 SECTION 6 SECTION 8 SECTION 4
Every 200 Hours	Change oil filter.	SECTION 6
Annually Or Every 500 Hours	Service starter motor drive.	SECTION 8

¹ Perform these maintenance procedures more frequently under extremely dusty, dirty conditions.

STORAGE

If the engine will be out of service for two months or more, use the following storage procedure:

1. Change the oil and oil filter while the engine is still warm from operation. See "Change Oil And Oil Filter" in Section 6.
2. Drain the fuel tank and fuel system (or run the engine until the fuel tank and fuel system are empty).
3. Remove the spark plug. Add one tablespoon of engine oil into the spark plug hole. Install the plug, but do not connect the plug lead. Crank the engine two or three revolutions.
4. Remove the spark plug and rotate the crankshaft until the piston is at the top of its stroke. Reinstall the plug, but do not connect the plug lead.
5. Clean the exterior surfaces of the engine.
6. Store the engine in a clean, dry place.

SECTION 1

GENERAL INFORMATION

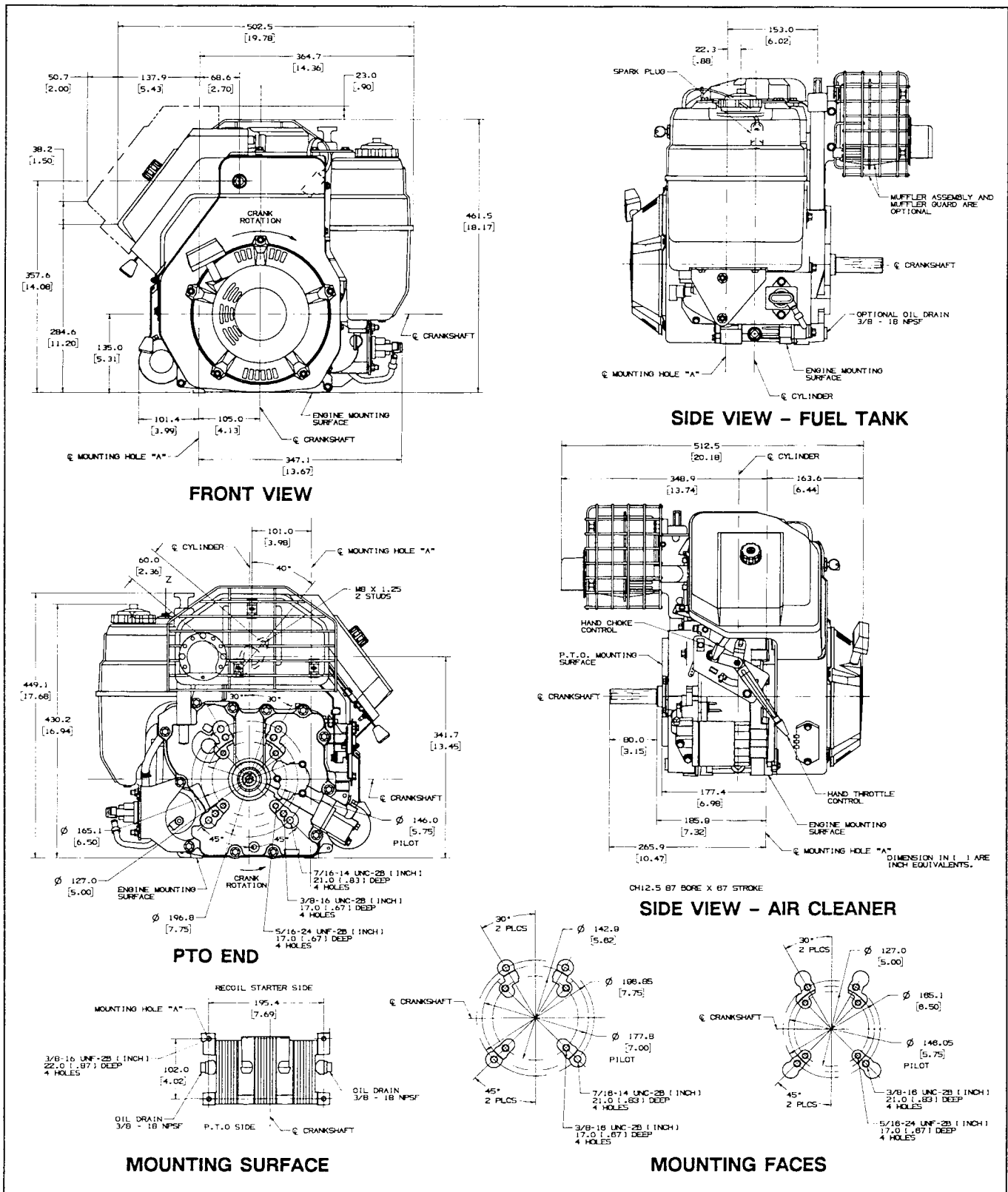
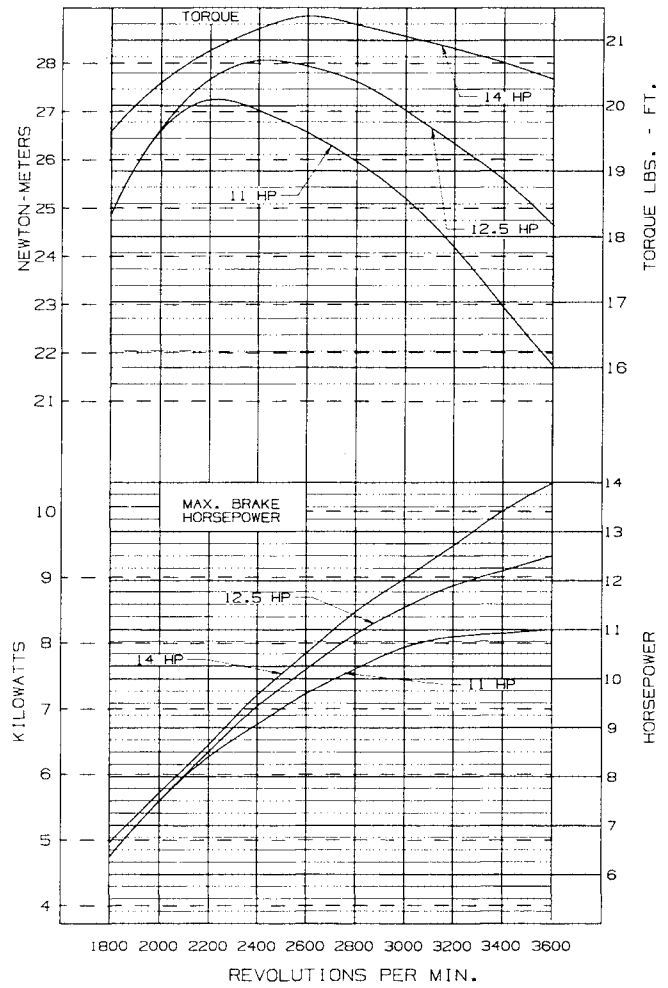

Figure 1-4. Typical Engine Dimensions.

SECTION 1
GENERAL INFORMATION

TORQUE

HORSEPOWER



FUEL

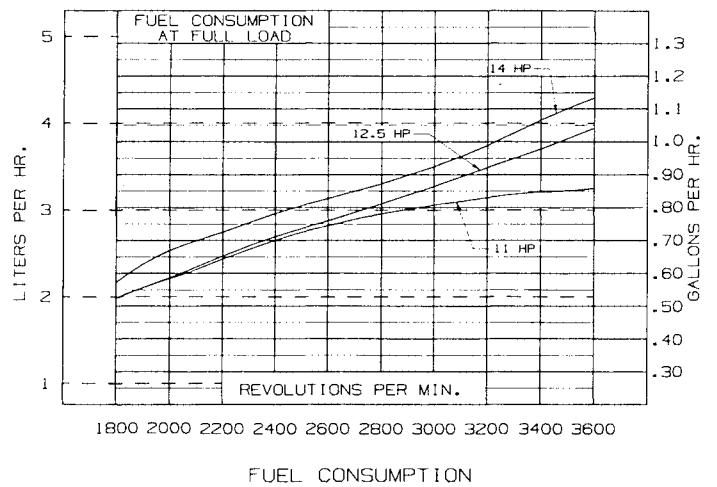







Figure 1-5. Power, Torque, And Fuel Data.





SECTION 1

GENERAL INFORMATION

TORQUE INFORMATION, SPECIFICATIONS, AND TOLERANCES

Metric Fastener Torque Recommendations For Standard Applications

Tightening Torque: N•m (lbf•in) + or – 10%						Noncritical Fasteners Into Aluminum
	Property Class					
						
Size						
M4	1.2 (11)	1.7 (15)	2.9 (26)	4.1 (36)	5.0 (44)	2.0 (18)
M5	2.5 (22)	3.2 (28)	5.8 (51)	8.1 (72)	9.7 (86)	4.0 (35)
M6	4.3 (38)	5.7 (50)	9.9 (88)	14.0 (124)	16.5 (146)	6.8 (60)
M8	10.5 (93)	13.6 (120)	24.4 (216)	33.9 (300)	40.7 (360)	17.0 (150)

Tightening Torque: N•m (lbf•ft) + or – 10%						Noncritical Fasteners Into Aluminum
	Property Class					
						
Size						
M10	21.7 (16)	27.1 (20)	47.5 (35)	66.4 (49)	81.4 (60)	33.9 (25)
M12	36.6 (27)	47.5 (35)	82.7 (61)	116.6 (86)	139.7 (103)	61.0 (45)
M14	58.3 (43)	76.4 (55)	131.5 (97)	184.4 (136)	219.7 (162)	94.9 (70)

Oil Drain Plugs Tightening Torque: N•m (English Equiv.)

Size	Into Cast Iron	Into Aluminum
1/8" NPT	-----	4.5 (40 lbf•in)
1/4"	17.0 (150 lbf•in)	11.3 (100 lbf•in)
3/8"	20.3 (180 lbf•in)	13.6 (120 lbf•in)
1/2"	27.1 (20 lbf•ft)	17.6 (13 lbf•ft)
3/4"	33.9 (25 lbf•ft)	21.7 (16 lbf•ft)
X-708-1	27.1/33.9 (20/25 lbf•ft)	27.1/33.9 (20/25 lbf•ft)

Torque Conversions

N•m = lbf•in x 0.113
 N•m = lbf•ft x 1.356
 lbf•in = N•m x 8.85
 lbf•ft = N•m x 0.737

SECTION 1 GENERAL INFORMATION

SPECIFICATIONS, TOLERANCES, AND SPECIAL TORQUE VALUES¹

DESCRIPTION Command 11, 12.5, 14 Hp

General Specifications

Power (@ 3600 rpm, corrected to SAE J1349)

Command 11	8.20 kW (11 hp)
Command 12.5	9.33 kW (12.5 hp)
Command 14	10.50 kW (14 hp)

Peak Torque

Command 11	27.4 N•m (20.2 lbf•ft)
Command 12.5	27.8 N•m (20.5 lbf•ft)
Command 14	28.9 N•m (21.3 lbf•ft)

Bore 87 mm (3.43 in)

Stroke 67 mm (2.64 in)

Displacement 398 cm³ (24.3 in³)

Compression Ratio 8.5:1

Approx. Weight 36.3 kg (80 lb)

Approx. Oil Capacity 1.9 L (2.0 U.S. qt)

Air Cleaner

Base Nut Torque 9.9 N•m (88 lbf•in)

Angle Of Operation – Maximum (At Full Oil Level)

Intermittent – All Directions 35°

Continuous – All Directions 25°

Balance Shaft

End Play (Free) 0.0575/0.3625 mm (0.0023/0.0143 in)

Running Clearance 0.025/0.063 mm (0.0009/0.0025 in)

Bore I.D. – New 20.000/20.025 mm (0.7874/0.7884 in)

Bore I.D. – Max. Wear Limit 20.038 mm (0.7889 in)

Balance Shaft Bearing Surface O.D. – New 19.962/19.975 mm (0.7859/0.7864 in)

Balance Shaft Bearing Surface O.D. – Max. Wear Limit 19.959 mm (0.7858 in)

Camshaft

End Play (With Shims) 0.076/0.127 mm (0.003/0.005 in)

Running Clearance 0.025/0.063 mm (0.0010/0.0025 in)

Bore I.D. – New 20.000/20.025 mm (0.7874/0.7884 in)

Bore I.D. – Max. Wear Limit 20.038 mm (0.7889 in)

Camshaft Bearing Surface O.D. – New 19.962/19.975 mm (0.7859/0.7864 in)

Camshaft Bearing Surface O.D. – Max. Wear Limit 19.959 mm (0.7858 in)

SECTION 1

GENERAL INFORMATION

Carburetor

Preliminary Low Idle Fuel Needle Setting

Command 11	1-1/4 Turn
Command 12.5	1-1/4 Turn
Command 14	1-3/4 Turn
Fuel Bowl Nut Torque	5.1/6.2 N•m (45/55 lbf•in)

Charging

Stator Mounting Screw Torque	4.0 N•m (35 lbf•in)
------------------------------------	---------------------

Closure Plate

Oil Filter Torque	5.7/9.0 N•m (50/80 lbf•in)
Oil Filter Drain Plug (1/8" NPT) Torque	7.3/9.0 N•m (65/80 lbf•in)
Closure Plate Fastener Torque	24.4 N•m (216 lbf•in)
Oil Sentry Pressure Switch Torque	7.9 N•m (70 lbf•in)
Oil Pump Cover Fastener Torque ²	4.0*6.2 N•m (35*55 lbf•in)
Oil Filter Adapter Fastener Torque	11.3 N•m (100 lbf•in)

Connecting Rod

Connecting Rod Cap Fastener Torque	22.6 N•m (200 lbf•in)
Connecting Rod To Crankpin Running Clearance — New	0.030/0.055 mm (0.0012/0.0022 in)
Connecting Rod To Crankpin Running Clearance — Max. Wear Limit	0.07 mm (0.0025 in)
Connecting Rod To Crankpin Side Clearance	0.18/0.41 mm (0.007/0.016 in)
Connecting Rod To Piston Pin Running Clearance	0.015/0.028 mm (0.0006/0.0011 in)
Piston Pin End I.D. — New	19.015/19.023 mm (0.7486/0.7489 in)
Piston Pin End I.D. — Max. Wear Limit	19.036 mm (0.7495 in)

Crankcase

Governor Cross Shaft Bore I.D. — New	6.025/6.050 mm (0.2372/0.2382 in)
Governor Cross Shaft Bore I.D. — Max. Wear Limit	6.063 mm (0.2387 in)

Crankshaft

End Play (Free)	0.0575/0.4925 mm (0.0023/0.0194 in)
Crankshaft Sleeve Bearing I.D. — (Installed) New	44.965/45.003 mm (1.7703/1.7718 in)
Crankshaft Sleeve Bearing I.D. — Max. Wear Limit	45.016 mm (1.7723 in)
Crankshaft To Sleeve Bearing Running Clearance — New	0.03/0.09 mm (0.0012/0.0035 in)
Crankshaft Bore (In Oil Pan) To Crankshaft Running Clearance — New	0.03/0.09 mm (0.0012/0.0035 in)
Flywheel End Main Bearing (O.D. — New)	44.913/44.935 mm (1.7682/1.7691 in)
(O.D. — Max. Wear Limit)	44.84 mm (1.765 in)
(Max. Taper)	0.022 mm (0.0009 in)
(Max. Out Of Round)	0.025 mm (0.0010 in)

SECTION 1

GENERAL INFORMATION

Closure Plate End Main Bearing Journal

(O.D. — New)	41.915/41.935 mm (1.6502/1.6510 in)
(O.D. — Max. Wear Limit)	41.86 mm (1.648 in)
(Max. Taper)	0.020 mm (0.0008 in)
(Max. Out Of Round)	0.025 mm (0.0010 in)

Connecting Rod Journal

(O.D. — New)	38.958/38.970 mm (1.5338/1.5343 in)
(O.D. — Max. Wear Limit)	38.94 mm (1.5328 in)
(Max. Taper)	0.012 mm (0.0005 in)
(Max. Out Of Round)	0.025 mm (0.0010 in)

Crankshaft T.I.R.

(PTO End, Crank In Engine)	0.15 mm (0.0059 in)
(Entire Crank, In V-Blocks)	0.10 mm (0.0039 in)

Cylinder Bore

Cylinder Bore I.D. — New	87.000/87.025 mm (3.4252/3.4262 in)
Cylinder Bore I.D. — Max. Wear Limit	87.063 mm (3.4277 in)
Cylinder Bore I.D. — Max. Out Of Round	0.12 mm (0.0047 in)
Cylinder Bore I.D. — Max. Taper	0.05 mm (0.0020 in)

Cylinder Head

Cylinder Head Fastener Torque	40.7 N•m (30 lbf•ft)
Max. Out Of Flatness	0.076 mm (0.003 in)
Rocker Pedestal Fastener Torque	9.9 N•m (88 lbf•in)

Electric Starter

Drive Pinion Fastener Torque	15.3 N•m (135 lbf•in)
Drive Pinion To Flywheel Ring Gear Backlash	0.025/1.56 mm (0.001/0.061 in)

Fan/Flywheel

Fan Fastener Torque	9.9 N•m (88 lbf•in)
Flywheel Retaining Screw Torque	66.4 N•m (49 lbf•ft)

Fuel Pump

Fuel Pump/Cover Fastener Screw Torque ²	7.3*9.0 N•m (65*80 lbf•in)
--	----------------------------

Fuel Tank

Fuel Tank Fastener Torque	7.3 N•m (65 lbf•in)
---------------------------------	---------------------

SECTION 1

GENERAL INFORMATION

Governor

Governor Cross Shaft To Crankcase Running Clearance	0.025/0.075 mm (0.0010/0.0030 in)
Governor Cross Shaft O.D. — New	5.975/6.000 mm (0.2352/0.2362 in)
Governor Cross Shaft O.D. — Max. Wear Limit	5.962 mm (0.2347 in)
Governor Gear Shaft To Governor Gear Running Clearance	0.015/0.140 mm (0.0006/0.0055 in)
Governor Gear Shaft O.D. — New	5.990/6.000 mm (0.2358/0.2362 in)
Governor Gear Shaft O.D. — Max. Wear Limit	5.977 mm (0.2353 in)

Ignition

Spark Plug Type (Champion Or Equiv.)	RC12YC
Spark Plug Gap	1.02 mm (0.040 in)
Spark Plug Torque	38.0/43.4 N•m (28/32 lbf•ft)
Ignition Module Air Gap	0.203/0.305 mm (0.008/0.012 in)
Ignition Module Fastener Torque ²	4.0*6.2 N•m (35*55 lbf•in)

Muffler

Muffler Retaining Nuts	24.4 N•m (216 lbf•in)
------------------------	-----------------------

Piston, Piston Rings, And Piston Pin

Piston To Piston Pin (Selective Fit)	0.006/0.017 mm (0.0002/0.0007 in)
Piston Pin Bore I.D. — New	19.006/19.012 mm (0.7483/0.7485 in)
Piston Pin Bore I.D. — Max. Wear Limit	19.025 mm (0.7490 in)
Piston Pin O.D. — New	18.995/19.000 mm (0.7478/0.7480 in)
Piston Pin O.D. — Max. Wear Limit	18.994 mm (0.74779 in)
Top Compression Ring To Groove Side Clearance	0.040/0.105 mm (0.0016/0.0041 in)
Middle Compression Ring To Groove Side Clearance	0.040/0.072 mm (0.0016/0.0028 in)
Oil Control Ring To Groove Side Clearance	0.551/0.675 mm (0.0217/0.0266 in)
Top And Center Compression Ring End Gap — New Bore	0.3/0.5 mm (0.012/0.020 in)
Top And Center Compression Ring End Gap — Used Bore (Max.)	0.77 mm (0.030 in)
Piston Thrust Face (@D ₁) To Cylinder Bore Running Clearance — New ³	0.041/0.044 mm (0.0016/0.0017 in)

SECTION 1 GENERAL INFORMATION

Retractable Starter

Center Screw Torque 7.4/8.5 N•m (65/75 lbf•in)

Throttle/Choke Controls

Governor Control Lever Fastener Torque 9.9 N•m (88 lbf•in)

Speed Control Bracket Assembly Fastener Torque² 7.3*10.7 N•m (65*95 lbf•in)

Valve Cover/Rocker Arms

Valve Cover Fastener Torque² 7.3*10.7 N•m (65*95 lbf•in)

Rocker Arm I.D. — New 15.837/16.127 mm (0.63/0.64 in)

Rocker Arm I.D. — Max. Wear Limit 16.13 mm (0.640 in)

Rocker Shaft O.D. — New 15.90/15.85 mm (0.63 in)

Rocker Shaft O.D. — Max. Wear Limit 15.727 mm (0.619 in)

Valves And Valve Lifters

Hydraulic Valve Lifter To Crankcase Running Clearance 0.0124/0.0501 mm (0.0005/0.0020 in)

Intake Valve Stem To Valve Guide Running Clearance 0.038/0.076 mm (0.0015/0.0030 in)

Exhaust Valve Stem To Valve Guide Running Clearance 0.050/0.088 mm (0.0020/0.0035 in)

Intake Valve Guide I.D. — New 7.038/7.058 mm (0.2771/0.2779 in)

Intake Valve Guide I.D. — Max. Wear Limit 7.134 mm (0.2809 in)

Exhaust Valve Guide I.D. — New 7.038/7.058 mm (0.2771/0.2779 in)

Exhaust Valve Guide I.D. — Max. Wear Limit 7.159 mm (0.2819 in)

Valve Guide Reamer Size — STD 7.048 mm (0.2775 in)

Valve Guide Reamer Size — 0.25 mm O.S. 7.298 mm (0.2873 in)

Intake Valve Minimum Lift 8.96 mm (0.353 in)

Exhaust Valve Minimum Lift 9.14 mm (0.360 in)

Nominal Valve Seat Angle 45°

NOTES:

¹ Values are in Metric units. Values in parenthesis are English equivalents. Lubricate threads with engine oil prior to assembly.



² For self-tapping (thread forming) fasteners: the higher torque value is for initial installation into a new cored hole*the lower torque value is for subsequent installation and installation into tapped holes and weld nuts.

³ Measure 6 mm (0.236 in) above the bottom of the piston skirt at right angles to the piston pin.

SECTION 1

GENERAL INFORMATION

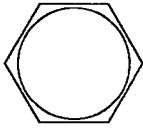
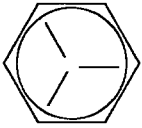
English Fastener Torque Recommendations For Standard Applications

Tightening Torque: N·m (lbf·in) + or - 20%				
Bolts, Screws, Nuts And Fasteners Assembled Into Cast Iron Or Steel				Grade 2 Or 5 Fasteners Into Aluminum
	 Grade 2	 Grade 5	 Grade 8	
Size				
8-32	2.3 (20)	2.8 (25)	_____	2.3 (20)
10-24	3.6 (32)	4.5 (40)	_____	3.6 (32)
10-32	3.6 (32)	4.5 (40)	_____	_____
1/4-20	7.9 (70)	13.0 (115)	18.7 (165)	7.9 (70)
1/4-28	9.6 (85)	15.8 (140)	22.6 (200)	_____
5/16-18	17.0 (150)	28.3 (250)	39.6 (350)	17.0 (150)
5/16-24	18.7 (165)	30.5 (270)	_____	_____
3/8-16	29.4 (260)	_____	_____	_____
3/8-24	33.9 (300)	_____	_____	_____
Tightening Torque N·m (lbf·ft) + or - 20%				
Size				
5/16-24	_____	_____	40.7 (30)	_____
3/8-16	_____	47.5 (35)	67.8 (50)	_____
3/8-24	_____	54.2 (40)	81.4 (60)	_____
7/16-14	47.5 (35)	74.6 (55)	108.5 (80)	_____
7/16-20	61.0 (45)	101.7 (75)	142.4 (105)	_____
1/2-13	67.8 (50)	108.5 (80)	155.9 (115)	_____
1/2-20	94.9 (70)	142.4 (105)	223.7 (165)	_____
9/16-12	101.7 (75)	169.5 (125)	237.3 (175)	_____
9/16-18	135.6 (100)	223.7 (165)	311.9 (230)	_____
5/8-11	149.2 (110)	244.1 (180)	352.6 (260)	_____
5/8-18	189.8 (140)	311.9 (230)	447.5 (330)	_____
3/4-10	199.3 (150)	332.2 (245)	474.6 (350)	_____
3/4-16	271.2 (200)	440.7 (325)	637.3 (470)	_____

SECTION 2 SPECIAL TOOLS

SPECIAL SERVICE TOOL KITS

These quality tools are designed to help you perform specific disassembly, repair, and reassembly procedures. By using tools designed for the job, you can service engines easier, faster, and safer! In addition, you'll increase your service capabilities and customer satisfaction by decreasing engine down time.

Tool Kit No. KO-3211-A — This basic tool kit includes tools necessary to service Kohler K-Series and Magnum engines. It includes the tools originally sold as kit NU-3211 and the new tools kit no. KO-3212.

Tool Kit No. KO-3212 — This kit updates original tool kit No. NU-3211 to include all new tools released in 1986 and 1987. Specifically, the kit includes fixed jet carburetor Welch plug removal and installation, cam-

shaft pin and camshaft pin cup plug installation, MV oil seal installation tools, and a tool board.

COMMAND Tool Kit No. KO-3213 — This kit is designed for the current Kohler Engine Service Dealer already having the KO-3211-A basic tool kit. This kit includes all additional tools necessary to service current Command series engines.

COMMAND Tool Kit No. KO-3214 — This kit is for the new Kohler Dealer servicing the Command series engines *only*.

COMMAND Tool Kit No. KO-3215 — This kit is for the new Kohler Dealer servicing the Command 11, 12.5, 14 models *only*.

To avoid tool duplication, and to ensure you have all necessary tools, refer to the following table:



IF YOU ARE CURRENTLY	SERVICING	ORDER KIT NO.				
		KO-3211-A	KO-3212	KO-3213	KO-3214	KO-3215
New/Existing Kohler Dealer "No Tools"	K, M, & C	X		X		
Existing Kohler Dealer With NU-3211 Kit	K & M		X			
Existing Kohler Dealer With NU-3211 Kit	K, M, & C		X	X		
Existing Kohler Dealer With KO-3211-A Kit	K, M, & C			X		
Existing Kohler Dealer Command Only	C				X	
Existing Kohler Dealer Command 11, 12.5, 14 Only	C					X

K = K-Series Engines
M = Magnum Engines
C = Command Engines

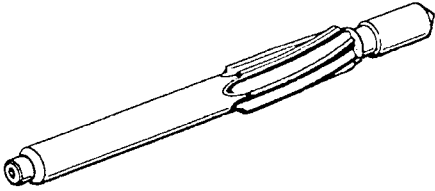
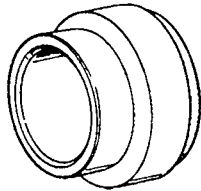
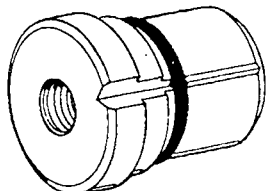
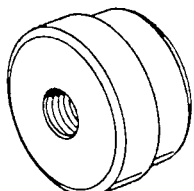

KO-3211-A = Standard Tool Kit For K-Series And Magnum Engines (Includes Kits NU-3211 And KO-3212)
KO-3212 = Add On Kit For NU-3211 (Kit KO-3212 + Kit NU-3211 = Kit KO-3211-A)
KO-3213 = Add On Kit For Command Series Engines (To Be Used With Kit KO-3211-A)
KO-3214 = Command Dealer Tool Kit
KO-3215 = Command 11, 12.5, 14 Dealer Tool Kit

SECTION 2 SPECIAL TOOLS

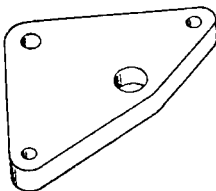
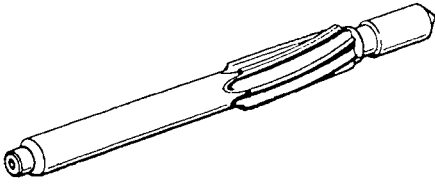
Kit KO-3213 Includes:

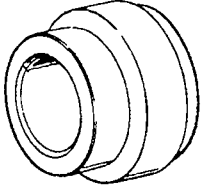
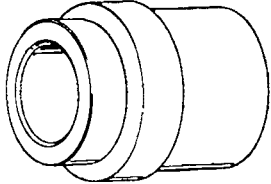

Tool No.	Description	Application	Illustration
KO-1026	REAMER (Oversize Valve Guide)	Used to ream valve guides.	
KO-1027	OIL SEAL INSTALLER (Flywheel, PTO)	Used to install oil seals to the proper depth. Use with KO-1036 handle.	
KO-1028	CRANKSHAFT BEARING INSTALLER	Used to install main bearing. Use with NU-4747 handle.	
KO-1029	CRANKSHAFT BEARING REMOVER	Used to remove main bearing. Use with NU-4747 handle.	
KO-1030	GOVERNOR SHAFT SEAL INSTALLER	Used to install governor shaft seal.	
KO-1031	CAMSHAFT ENDPLAY PLATE	Used to check camshaft endplay. (All necessary hardware is included.)	
KO-1033	REAMER (Oversize Valve Guide)	Used to ream valve guides – CH5.	

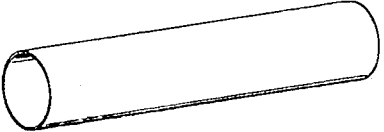
SECTION 2 SPECIAL TOOLS

Tool No.	Description	Application	Illustration
KO-1034	OIL SEAL INSTALLER (Flywheel, PTO)	Used to install oil seals to the proper depth – CH5. Use with KO-1036 handle.	
KO-1035	CAMSHAFT PTO OIL SEAL INSTALLER	Used to install the camshaft PTO oil seal to the proper depth – CH5. Use with KO-1036 handle.	
KO-1036	DRIVING HANDLE	Used with oil seal installers.	
KO-1037	SEAL PROTECTOR SLEEVE	Used on crankshaft when installing oil seals.	
208665	HEX CAP SCREW	Used with flywheel puller kit (NU-3226) – All. (M8x1.25x70 mm)	NOT ILLUSTRATED
10257	FLAT WASHER	Used with flywheel puller kit – All.	
KO-1039	SILO PACK, HOOKS, SCREWS	Used with KO-3213 kit.	

SECTION 2 SPECIAL TOOLS

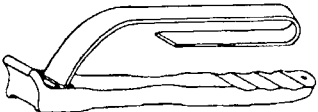
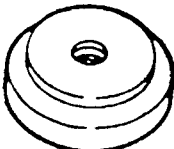
Kit KO-3214 Includes All Of The Above Tools Plus The Following:

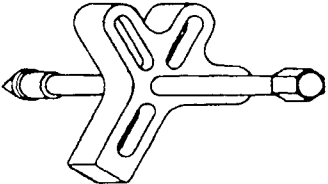
Tool No.	Description	Application	Illustration
NU-4747	HANDLE	Used to install and remove bearings.	
NU-10357	FLYWHEEL STRAP WRENCH	Used to hold flywheel. (For replacement strap, order part no. 305085.)	
NU-12018	BEARING INSTALLER	Used to install main bearings – CH5. Use with NU-4747 handle.	
NU-12021	SEAL PROTECTOR SLEEVE	Used on crankshaft when installing oil seals – CH5.	
NU-3226	FLYWHEEL PULLER KIT	Used to remove flywheel. (All hardware included.)	
KO-1038 KO-1040	TOOL BOARD SILO PACK, HOOKS, SCREWS	Used with KO-3214 kit.	NOT ILLUSTRATED

SECTION 2 SPECIAL TOOLS

Kit No. KO-3214 Tool Usage Chart

Tool Number	Description	C5	CV and CH 11,12.5, 14
KO-1026	Reamer, Oversized Valve Guide		X
KO-1027	Oil Seal Installer (Flywheel)		X
KO-1028	Crankshaft Bearing Installer		X
KO-1029	Crankshaft Bearing Remover		X
KO-1030	Governor Shaft Seal Installer		X
KO-1031	Camshaft Endplay Plate		X
KO-1033	Reamer, Oversized Valve Guide	X	
KO-1034	Oil Seal Installer (Flywheel, PTO)	X	
KO-1035	Camshaft PTO Oil Seal Installer	X	
KO-1036	Driving Handle	X	X
KO-1037	Seal Protector Sleeve		X
208665	Hex Cap Screw (M8x1.25x70 mm)	X	X
10257	Flat Washers	X	X
208562	Hex Cap Screws (M8x1.25x20 mm)		X
KO-1039	Silo Pack, Hooks, And Screws (KO-3213)	X	X
NU-3226	Flywheel Puller Kit	X	X
NU-4747	Handle	X	X
NU-10357	Flywheel Strap Wrench	X	X
NU-12018	Bearing Installer	X	
NU-12021	Seal Protector Sleeve	X	
KO-1038	Tool Board	X	X
KO-1040	Silo Pack, Hooks, And Screws (KO-3214)	X	X

Service tool kits can be ordered complete or the tools can be ordered individually. Contact your Kohler Distributor for price and availability.

SECTION 2 SPECIAL TOOLS

ENGINE ANALYSIS KIT NO. KO 25 800 01

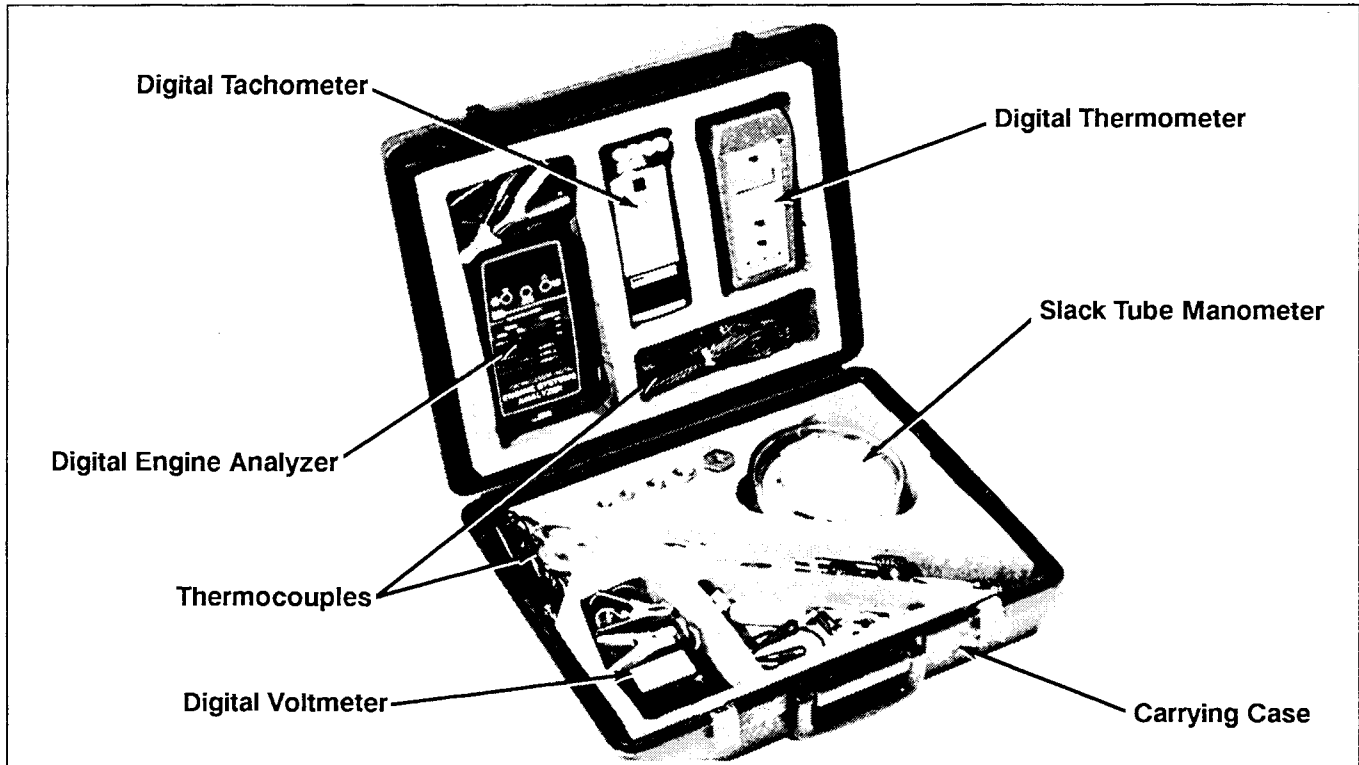

Figure 2-1. Engine Analysis Kit – 25 800 01

The Kohler Engine Analysis Kit contains a selection of instruments that will enable you to measure critical items that relate to engine performance. You will find many uses for these instruments — from basic crankcase vacuum checks to sophisticated application tests.

The Engine Analysis Kit Includes:

Qty.	Description	Part No.
1	Digital Voltmeter	KO 25 800 02
1	Digital Tachometer	KO 25 800 03
1	Digital Thermometer	KO 25 800 04
1	Digital Engine Analyzer	KO 25 800 05
1	Slack Tube Manometer	KO 25 800 06
1	8 Ft. Lead With Plug	KO 25 800 07
3	14mm Spark Plug	
	Thermocouple	KO 25 800 08
2	Head Bolt Thermocouple	KO 25 800 09
1	Oil Sump Thermocouple	KO 25 800 10
1	1/4" x 1/8" Bushing	KO 25 800 11
1	3/8" x 1/8" Bushing	KO 25 800 12
1	1/2" x 1/8" Bushing	KO 25 800 13
1	3/4" x 1/8" Bushing	KO 25 800 14
1	Tube With Fittings	KO 25 800 15
1	Carrying Case	KO 25 800 16
3	Plain Thermocouple	KO 25 800 17

The voltmeter, tachometer, and engine analyzer feature electronic circuitry and digital readouts. Guidelines for using the instruments and testing are included.

Using the instruments in the kit you will be able to:

1. Measure the temperatures of the:
 - a. spark plug base gasket/cylinder head bolt,
 - b. oil sump, and
 - c. air into flywheel and carburetor.
2. Measure engine speed (rpm).
3. Measure crankcase vacuum and exhaust system back pressure.

4. Measure voltage.

5. Measure charging system current.

6. Measure electric starter current (Amp) draw.

The Engine Analysis Kit can be ordered complete as shown, or the instruments can be ordered individually. Contact your Kohler Distributor for price and availability.

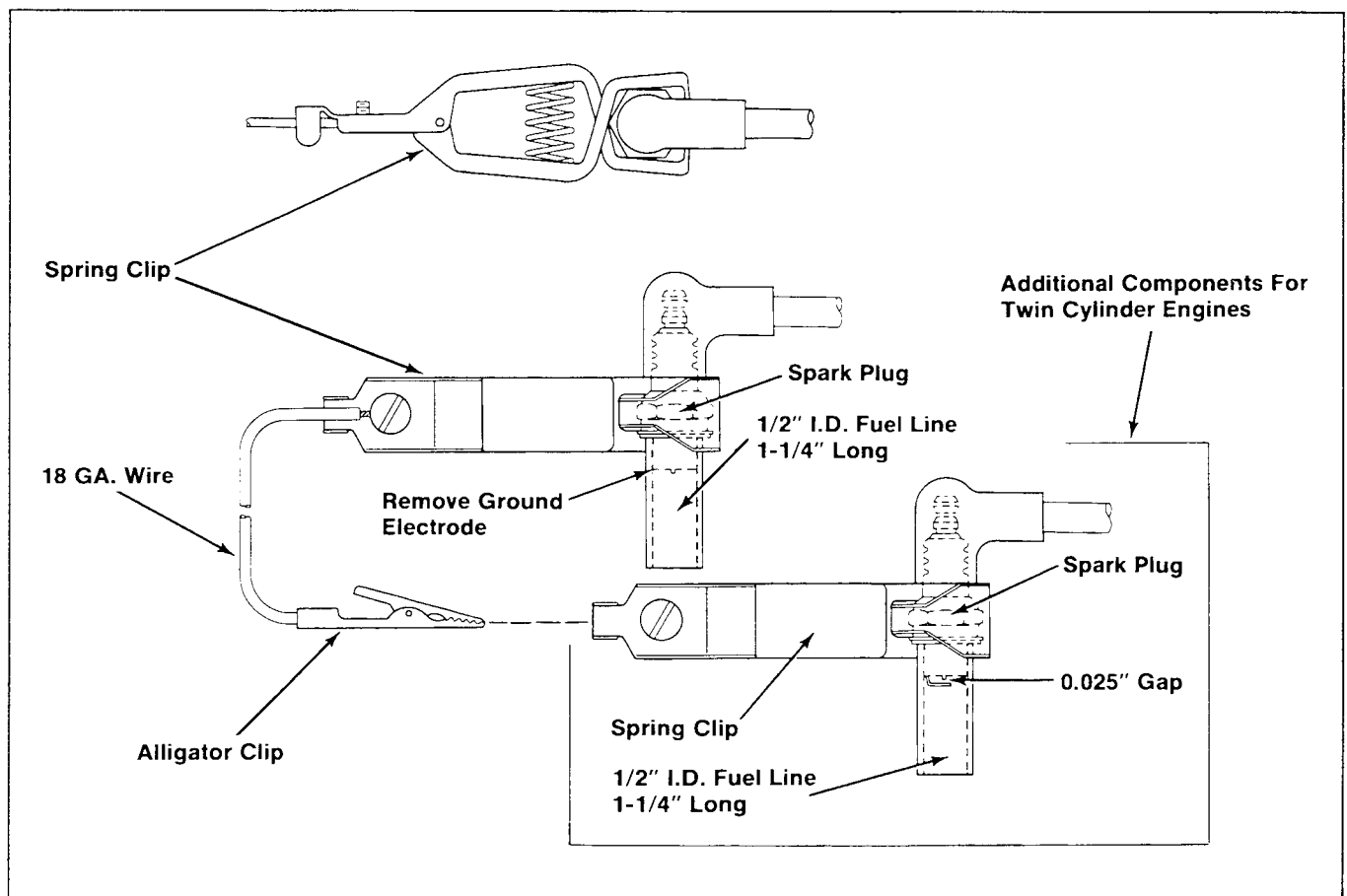

Figure 2-2. Electronic Magneto Ignition System Tester.

IGNITION SYSTEM TESTER

These engines are equipped with a dependable electronic magneto ignition system. A simple tester can be used to determine if the ignition module is functioning properly. See Figure 2-2.

SECTION 2 SPECIAL TOOLS

Tester Construction

1. Obtain a new RJ-8 or RCJ-8 spark plug.
2. Remove the ground electrode from the spark plug. This gives a spark gap of approx. 3.3 mm (0.13 in). This large gap simulates the spark required under actual engine conditions.
3. Make a lead assembly using a large spring clip, an alligator clip, and 18 gauge wire.
4. Cut a 32 mm (1-1/4 in) length of 13 mm (1/2 in) I.D. fuel line. Slide it onto the threads of the test plug. The fuel line shades the firing tip to make the spark more visible.

Using The Tester

Follow the instructions given in Section 8 — “Electrical System And Components.”

ELECTRIC STARTER BRUSH HOLDER TOOL

The electric starter motor brush holder will make the installation of the commutator end cap to the starter frame much easier. The brush holder tool can easily be made from thin sheet metal. See Figure 2-3.

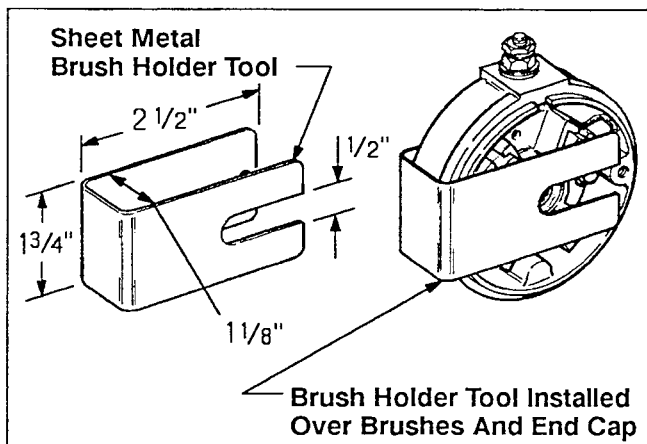

Figure 2-3. Brush Holder Tool.

RTV SILICONE SEALANT

RTV silicone sealant is used as a gasket between the crankcase and oil pan and between the rocker cover and cylinder head. **General Electric Silmate™ type RTV-1473, or RTV-108** (or equivalent) silicone sealant is recommended.

Silicone Sealant Dispenser

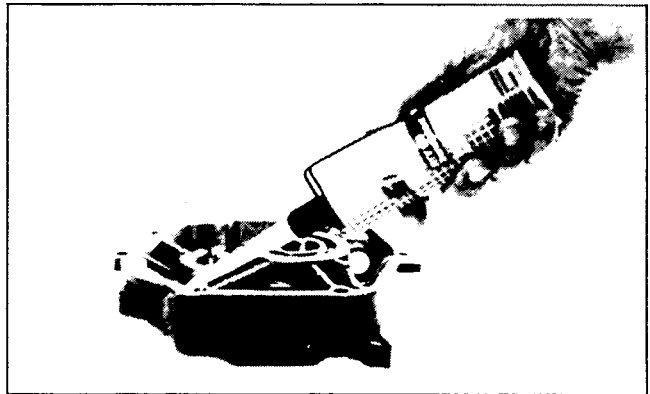

Figure 2-4. Silicone Sealant Dispenser.

An easy-to-use silicone sealant dispenser, **part no. 52 597 01**, is available. This dispenser contains 142cc (4.8 fl.oz.) of RTV-108. See Figure 2-4.

This dispenser also features easy-to-use One Touch® control, precise dispensing of the correct bead and amount of sealant, and a 1-year shelf life for an unopened can — 6 months shelf life after can has been opened.

To order, contact your source of supply.

SECTION 3

TROUBLESHOOTING

TROUBLESHOOTING GUIDE

When troubles occur, be sure to check the simple causes which, at first, may seem too obvious to be considered. For example, a starting problem could be caused by an empty fuel tank.

Some common causes of engine troubles are listed below. Use these to locate the causing factors.

Engine Cranks But Will Not Start

1. Empty fuel tank
2. Fuel shutoff valve closed
3. Dirt or water in the fuel system
4. Clogged fuel line
5. Spark plug lead disconnected
6. Keyswitch or kill switch in "off" position
7. Faulty spark plug
8. Faulty ignition module

Engine Starts But Does Not Keep Running

1. Restricted fuel tank vent
2. Dirt or water in the fuel system
3. Faulty choke or throttle controls/cables
4. Loose wires or connections that short the kill terminal of ignition module to ground
5. Faulty cylinder head gasket
6. Faulty fuel pump
7. Faulty carburetor

Engine Starts Hard

1. Hydrostatic transmission not in neutral/PTO drive is engaged
2. Dirt or water in the fuel system
3. Clogged fuel line
4. Loose or faulty wires or connections
5. Faulty choke or throttle controls/cables
6. Faulty spark plug
7. Low compression
8. Faulty ACR mechanism

Engine Will Not Crank

1. Hydrostatic transmission not in neutral/PTO drive is engaged
2. Battery is discharged
3. Safety interlock switch is engaged
4. Loose or faulty wires or connections
5. Faulty keyswitch or ignition switch
6. Faulty electric starter/starter solenoid
7. Retractable starter not engaging in drive cup
8. Seized internal engine components

Engine Runs But Misses

1. Dirt or water in the fuel system
2. Spark plug lead disconnected
3. Loose wires or connections that intermittently short the kill terminal of ignition module to ground
4. Engine overheated
5. Faulty ignition module

SECTION 3

TROUBLESHOOTING

Engine Will Not Idle

1. Restricted fuel tank vent
2. Dirt or water in the fuel system
3. Faulty spark plug
4. Idle fuel adjusting needle improperly set
5. Idle speed adjusting screw improperly set
6. Low compression

Engine Overheats

1. Air intake/grass screen, cooling fins, or cooling shrouds clogged
2. Excessive engine load
3. Low crankcase oil level
4. High crankcase oil level

Engine Knocks

1. Excessive engine load
2. Low crankcase oil level
3. Old/improper fuel
4. Internal wear or damage

Engine Loses Power

1. Low crankcase oil level
2. High crankcase oil level
3. Dirty air cleaner element
4. Dirt or water in the fuel system
5. Excessive engine load
6. Engine overheated
7. Faulty spark plug
8. Low compression

Engine Uses Excessive Amount Of Oil

1. Incorrect oil viscosity/type
2. Clogged or improperly assembled breather
3. Worn or broken piston rings
4. Worn cylinder bore
5. Worn valve stems/valve guides

EXTERNAL ENGINE INSPECTION

Before cleaning or disassembling the engine, make a thorough inspection of its external appearance and condition. This inspection can give clues to what might be found inside the engine (and the cause) when it is disassembled.

- Check for buildup of dirt and debris on the crankcase, cooling fins, grass screen and other external surfaces. Dirt or debris on these areas are causes of overheating.

- Check for obvious fuel and oil leaks, and damaged components. Excessive oil leakage can indicate a clogged or improperly assembled breather, worn or damaged seals and gaskets, or loose or improperly torqued fasteners.

- Check the air cleaner cover and base for damage or indications of improper fit and seal.

- Check the air cleaner element. Look for holes, tears, cracked or damaged sealing surfaces, or other damage that could allow unfiltered air into the engine. Also note if the element is dirty or clogged. These could indicate that the engine has been underserviced.

- Check the carburetor throat for dirt. Dirt in the throat is further indication that the air cleaner is not functioning properly.

- Check the oil level. Note if the oil level is within the operating range on the dipstick, or if it is low or overfilled.

- Check the condition of the oil. Drain the oil into a container—the oil should flow freely. Check for metal chips and other foreign particles.

Sludge is a natural by-product of combustion; a small accumulation is normal. Excessive sludge formation could indicate the oil has not been changed at the recommended intervals, the incorrect type or weight of oil was used, overrich carburetion, and weak ignition, to name a few.

NOTE: It is good practice to drain oil at a location away from the workbench. Be sure to allow ample time for complete drainage.

CLEANING THE ENGINE

After inspecting the external condition of the engine, clean the engine thoroughly before disassembling it. Also clean individual components as the engine is disassembled. Only clean parts can be accurately inspected and gauged for wear or damage. There are many commercially available cleaners that will quickly remove grease, oil, and grime from engine parts. When such a cleaner is used, *follow the manufacturer's instructions and safety precautions carefully.*

Make sure all traces of the cleaner are removed before the engine is reassembled and placed into opera-

tion. Even small amounts of these cleaners can quickly break down the lubricating properties of engine oil.

BASIC ENGINE TESTS

Crankcase Vacuum Test

A partial vacuum should be present in the crankcase when the engine is operating at normal temperatures. Pressure in the crankcase (normally caused by a clogged or improperly assembled breather) can cause oil to be forced out at oil seals, gaskets, or other available spots.

Crankcase vacuum is best measured with a water manometer. The manometer included in the Kohler Engine Analysis Kit is recommended. Refer to Section 2 – “Special Tools” for more information.

Test the crankcase vacuum with the manometer as follows:

1. Insert the stopper/hose into the oil fill hole. Leave the other vent hose of manometer open to atmosphere.

Make sure the shutoff clamp is closed.

2. Start the engine and run at no-load high idle speed (3200 to 3750 rpm).
3. Open the clamp and note the water level in the tube.

The level in the engine side should be a minimum of **10.2 cm (4 in)** above the level in the open side.

If the level in the engine side is the same as the open side (no vacuum), or the level in the engine side is lower than the level in the open side (pressure), check for the conditions in the table below.

4. Close the shutoff clamp **before** stopping the engine.

Compression Test

These engines are equipped with an automatic compression release (ACR) mechanism. Because of the ACR mechanism, it is difficult to obtain an accurate compression reading.

To check the condition of the combustion chamber and related mechanisms, physical inspection and a crankcase vacuum test are recommended.

NO CRANKCASE VACUUM/PRESSURE IN CRANKCASE

Possible Cause	Solution
1. Crankcase breather clogged or inoperative.	1. Disassemble breather, clean parts thoroughly, reassemble, and recheck pressure.
2. Seals and/or gaskets leaking. Loose or improperly torqued fasteners.	2. Replace all worn or damaged seals and gaskets. Make sure all fasteners are tightened securely. Use appropriate torque values and sequences when necessary.
3. Piston blowby or leaky valves. (Confirm by inspecting components.)	3. Recondition piston, rings, cylinder bore, valves, and valve guides.
4. Restricted exhaust.	4. Repair/replace restricted muffler/exhaust system.

SECTION 3
TROUBLESHOOTING

SECTION 4

AIR CLEANER & AIR INTAKE SYSTEM

AIR CLEANER

These engines are equipped with a replaceable, high-density paper air cleaner element. Some engines are also equipped with an oiled-foam precleaner which surrounds the paper element. See Figures 4-1 and 4-2.

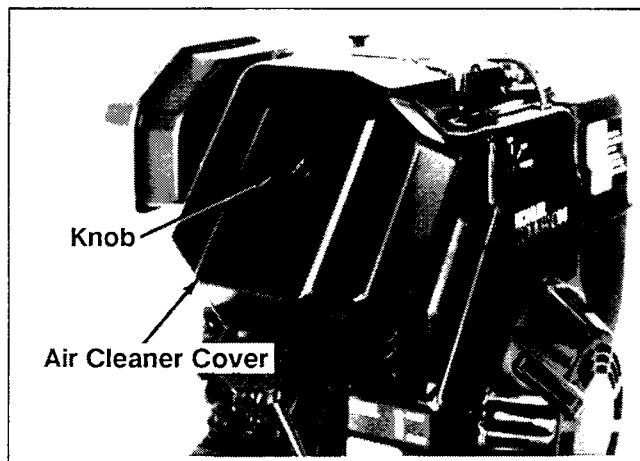

Figure 4-1. Air Cleaner Housing Components.

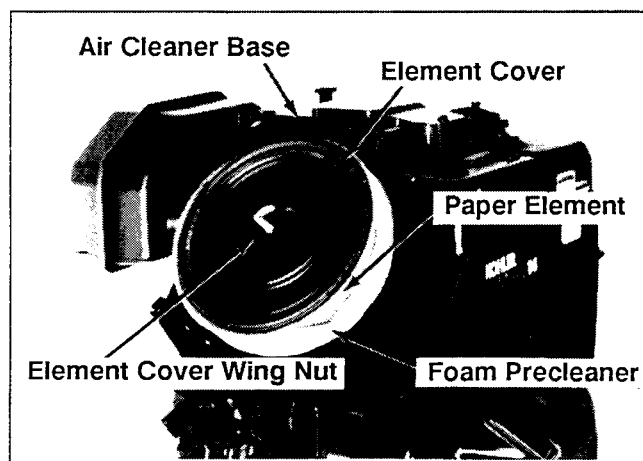

Figure 4-2. Air Cleaner Elements.

Air Cleaner Service

Check the air cleaner **daily or before starting the engine**. Check for and correct heavy buildup of dirt and debris, and loose or damaged components.

NOTE: Operating the engine with loose or damaged air cleaner components could allow unfiltered air into the engine causing premature wear and failure.

Service Precleaner

If so equipped, wash and recoil the precleaner every **25 hours** of operation (more often under extremely dusty or dirty conditions).

1. Remove the precleaner from the paper element.
2. Wash the precleaner in warm water with detergent. Rinse the precleaner thoroughly until all traces of detergent are eliminated. Squeeze out excess water (do not wring). Allow the precleaner to air-dry.
3. Saturate the precleaner with new engine oil. Squeeze out all excess oil.
4. Reinstall the precleaner over the paper element.
5. Reinstall air cleaner cover, and air cleaner cover retaining knob. Make sure the knob is tightened securely.

Service Paper Element

Every **100 hours** of operation (more often under extremely dusty or dirty conditions), check the paper element. Replace the element as necessary.

1. Remove the precleaner (if so equipped) from the paper element.
2. Remove the wing nut, washer, element cover, and air cleaner element.

SECTION 4

AIR CLEANER & AIR INTAKE SYSTEM

3. Do not wash the paper element or use pressurized air, as this will damage the element. Replace a dirty, bent, or damaged element with a genuine Kohler element. Handle new elements carefully; do not use of the sealing surfaces are bent or damaged.
4. Reinstall the paper element, element cover, washer, wing nut, precleaner, air cleaner cover, and air cleaner cover retaining knob. Make sure the knob is tightened securely.

Inspect Air Cleaner Components

Whenever the air cleaner cover is removed, or the paper element or precleaner are serviced, check the following areas/components:

Covered Air Cleaner Element — Inspect the rubber grommet in the hole of the air cleaner element cover. Replace the grommet if it is worn or damaged.

Air Cleaner Base — Make sure the base is secured and not cracked or damaged. Since the air cleaner base and carburetor are secured to the intake port with common hardware, it is extremely important that the nuts securing these components are tight at all times.

Breather Tube — Make sure the tube is installed to both the air cleaner base *and* valve cover.

NOTE: Damaged, worn, or loose air cleaner components can allow unfiltered air into the engine causing premature wear and failure. Tighten or replace all loose or damaged components.

Disassembly

The following procedure is for complete disassembly of all air cleaner components.

1. Remove the air cleaner cover retaining knob and air cleaner cover.
2. If so equipped, remove the precleaner from paper element.
3. Remove the wing nut, washer, element cover, and air cleaner element.
4. Disconnect the breather hose from the valve cover.
5. Remove the air cleaner base mounting nuts, air cleaner base, and gasket.
6. If necessary, remove the self-tapping screws and elbow from air cleaner base.

Reassembly

The following procedure is for complete assembly of all air cleaner components.

1. Install the elbow and self-tapping screws to air cleaner base.
2. Install the gasket, air cleaner base, and base mounting nuts. Torque the nuts to **9.9 N·m (88 lbf·in)**.
3. Connect the breather hose to the air cleaner base (and valve cover). Secure with hose clamps.
4. If necessary, install the grommet into the cover of air cleaner element. Install the air cleaner element, element cover, washer, and wing nut.
5. If so equipped, install the precleaner (washed and oiled) over the paper element.
6. Install the air cleaner cover and air cleaner cover retaining knob. Tighten the knob securely.

AIR INTAKE/COOLING SYSTEM

Clean Air Intake/Cooling Areas

To ensure proper cooling, make sure the grass screen, cooling fins, and other external surfaces of the engine are kept clean **at all times**.

Every **100 hours** of operation (more often under extremely dusty, dirty conditions), remove the blower housing and other cooling shrouds. Clean the cooling fins and external surfaces as necessary. Make sure the cooling shrouds are reinstalled.

NOTE: Operating the engine with a blocked grass screen, dirty or plugged cooling fins, and/or cooling shrouds removed, will cause engine damage due to overheating.

SECTION 5

FUEL SYSTEM AND GOVERNOR



Explosive Fuel!

Gasoline is extremely flammable and its vapors can explode if ignited. Before servicing the fuel system, make sure there are no sparks, open flames, or other sources of ignition nearby as these can ignite gasoline vapors. Disconnect and ground the spark plug lead to prevent the possibility of sparks from the ignition system.

FUEL RECOMMENDATIONS

General Recommendations

Purchase gasoline in small quantities and store in clean, approved containers. A container with a capacity of 2 gallons or less with a pouring spout is recommended. Such a container is easier to handle and helps eliminate spoilage during refueling.

Do not use gasoline left over from the previous season, to minimize gum deposits in your fuel system and to insure easy starting.

Do not add oil to the gasoline.

Do not overfill the fuel tank. Leave room for the fuel to expand.

Fuel Type

For best results, use only clean, fresh, unleaded gasoline with a pump sticker octane rating of 87 or higher. In countries using the Research method, it should be 90 octane minimum.

Unleaded gasoline is recommended, as it leaves less combustion chamber deposits. Leaded gasoline may be used in areas where unleaded is not available and exhaust emissions are not regulated. Be aware however, that the cylinder head will require more frequent service.

Gasoline/Alcohol blends

Gasohol (up to 10% ethyl alcohol, 90% unleaded gasoline by volume) is approved as a fuel for Kohler engines. Other gasoline/alcohol blends are not approved.

Gasoline/Ether blends

Methyl Tertiary Butyl Ether (MTBE) and unleaded gasoline blends (up to a maximum of 15% MTBE by volume) are approved as a fuel for Kohler engines. Other gasoline/ether blends are not approved.

FUEL SYSTEM

The typical fuel system and related components include the fuel tank, in-line fuel filter, fuel pump, carburetor, and interconnecting fuel lines.

Operation

The fuel from the tank is moved through the in-line filter and fuel lines by the fuel pump. On engines not equipped with a fuel pump, the fuel tank outlet is located above the carburetor inlet; gravity moves the fuel.

Fuel then enters the carburetor float bowl and is moved into the carburetor body. There, the fuel is mixed with air. This fuel-air mixture is then burned in the engine combustion chamber.

Troubleshooting

Use the following procedure to check if fuel is reaching the combustion chamber.

SECTION 5

FUEL SYSTEM AND GOVERNOR

Test	Conclusion
<p>1. Check for the following:</p> <ul style="list-style-type: none"> A. Make sure the fuel tank contains fuel. B. Make sure the vent in fuel tank is open. C. Make sure the fuel shutoff valve is open. 	
<p>2. Check for fuel in the combustion chamber.</p> <ul style="list-style-type: none"> A. Disconnect the spark plug lead. B. Close the choke on the carburetor. C. Crank the engine several times. D. Remove the spark plug and check for fuel at the tip. 	<p>2. If there is fuel at the tip of the spark plug, fuel is reaching the combustion chamber.</p> <p>If there is no fuel at the tip of the spark plug, check for fuel flow from the fuel tank. (Test 3.)</p>
<p>3. Check for fuel flow from the tank to the fuel pump.</p> <ul style="list-style-type: none"> A. Remove the fuel line from the inlet fitting of fuel pump. B. Hold the line below the bottom of the tank. Open the shutoff valve (if so equipped) and observe flow. 	<p>3. If fuel does flow from the line, check for faulty fuel pump. (Test 4.)</p> <p>If fuel does not flow from the line, check for clogged fuel tank vent, fuel pickup screen, shutoff valve, and fuel lines.</p>
<p>4. Check the operation of fuel pump.</p> <ul style="list-style-type: none"> A. Remove the fuel line from the inlet fitting of carburetor. B. Crank the engine several times and observe flow. 	<p>4. If fuel does flow from the line, check for faulty carburetor. (Refer to the "Carburetor" portions of this Section.)</p> <p>If fuel does not flow from the line, check for clogged fuel line. If the fuel line is unobstructed, the fuel pump is faulty and must be replaced.</p>

FUEL FILTER

Some engines are equipped with an in-line fuel filter. Visually inspect the filter periodically, and replace when dirty with a genuine Kohler filter.

FUEL PUMP

Some engines are equipped with an optional mechanically operated fuel pump. On applications using a gravity feed fuel system, the fuel pump mounting pad is covered with a metal plate.

The fuel pump body is constructed of nylon. The nylon body insulates the fuel from the engine crankcase. This prevents the fuel from vaporizing inside the pump.

Operation

The mechanical pump is operated by a lever which rides on the engine camshaft. The lever transmits a pumping action to the diaphragm inside the pump body. On the downward stroke of the diaphragm, fuel is drawn in through the inlet check valve. On the upward stroke of the diaphragm, fuel is forced out through the outlet check valve. See Figure 5-1.

SECTION 5 FUEL SYSTEM AND GOVERNOR

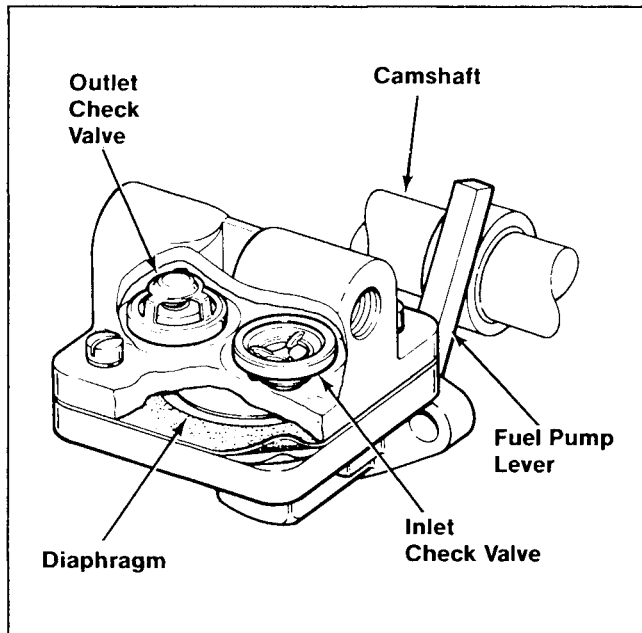

Figure 5-1. Cutaway—Typical Fuel Pump.

Removal

1. Disconnect the fuel lines from the inlet and outlet fittings of pump.
2. Remove the hex. flange screws, fuel pump, and gasket.
3. If necessary, remove the fittings from the pump body.

Repair

Nylon-bodied fuel pumps are not serviceable and must be replaced when faulty. Replacement pumps are available in kits that include the pump and mounting gasket.

Installation

1. **Fittings** — Apply a small amount of Permatex® Aviation Perm-A-Gasket (or equivalent) gasoline

resistant thread sealant to the threads of fittings. Turn the fittings into the pump **6 full turns**; continue turning the fittings in the same direction until the desired position is reached.

2. Install new gasket, fuel pump, and hex. flange screws.

NOTE: Make sure the fuel pump lever is positioned to the **RIGHT** of the camshaft (when looking at fuel pump mounting pad). Damage to the fuel pump, and subsequent severe engine damage could result if the lever is positioned to the left of the camshaft.

Torque the hex. flange screws as follows:

First Time Installation On A New Short Block — 9.0 N·m (80 lbf-in)

All Reinstallations — 7.3 N·m (65 lbf-in).

3. Connect the fuel lines to the inlet and outlet fittings.

CARBURETOR

These engines are equipped with an adjustable main jet carburetor. This subsection covers the troubleshooting, idle adjustment, and service procedures for the carburetor.



Explosive Fuel!

Gasoline may be present in the carburetor and fuel system. Gasoline is extremely flammable and its vapors can explode if ignited. Keep sparks, open flames, and other sources of ignition away from the engine. Disconnect and ground the spark plug lead to prevent the possibility of sparks from the ignition system.

SECTION 5 FUEL SYSTEM AND GOVERNOR

Troubleshooting

If engine troubles are experienced that appear to be fuel system related, check the following areas before adjusting or disassembling the carburetor.

- Make sure the fuel tank is filled with clean, fresh gasoline.
- Make sure the fuel tank cap vent is not blocked and that it is operating properly.
- Make sure fuel is reaching the carburetor. This includes checking the fuel shut-off valve, fuel tank filter screen, in-line fuel filter, fuel lines, and fuel

pump for restrictions or faulty components as necessary.

- Make sure the air cleaner base and carburetor is securely fastened to the engine using gaskets in good condition.
- Make sure the air cleaner element is clean and all air cleaner components are fastened securely.
- Make sure the ignition system, governor system, exhaust system, and throttle and choke controls are operating properly.

If the engine is hard-starting or runs roughly or stall at low idle speed, it may be necessary to adjust or service the carburetor.

Condition	Possible Cause/Probable Remedy
1. Engine starts hard, or runs roughly or stalls at idle speed.	1. Low idle fuel mixture or speed are improperly adjusted. Adjust the low idle speed screw, then adjust the low idle fuel needle.
2. Engine runs rich. (Indicated by black, sooty exhaust smoke, misfiring, loss of speed and power, governor hunting, or excessive throttle opening.)	2a. Choke partially closed during operation. Check the choke lever/linkage to ensure choke is operating properly. b. Low idle fuel mixture is improperly adjusted. Adjust low idle fuel needle. c. Float level is set too high. With fuel bowl removed and carburetor inverted, the exposed surface of float must be parallel with the bowl gasket surface of the carburetor body. d. Dirt under the fuel inlet needle. Remove needle; clean needle and seat and blow with compressed air. e. Bowl vent or air bleeds plugged. Remove fuel bowl, low idle fuel adjusting needle, and welch plugs. Clean vent, ports, and air bleeds. Blow out all passages with compressed air. f. Fuel bowl gasket leaks. Remove fuel bowl and replace gasket. g. Leaky, cracked, or damaged float. Submerge float to check for leaks.
3. Engine runs lean. (Indicated by misfiring, loss of speed and power, governor hunting, or excessive throttle opening.)	3a. Low idle fuel mixture is improperly adjusted. Adjust low idle fuel needle. b. Float level is set too low. With fuel bowl removed and carburetor inverted, the exposed surface of float must be parallel with the bowl gasket surface of the carburetor body. c. Idle holes plugged; dirt in fuel delivery channels. Remove fuel bowl, low idle fuel adjusting needle, and welch plugs. Clean main fuel jet and all passages; blow out with compressed air.
4. Fuel leaks from carburetor.	4a. Float level set too high. See Remedy 2c. b. Dirt under fuel inlet needle. See Remedy 2d. c. Bowl vent plugged. Remove fuel bowl and clean bowl vent. Blow out with compressed air. d. Float is cracked or damaged. Replace float. e. Bowl power screw gasket damaged. Replace gasket. f. Bowl power screw loose. Torque screw to specifications.

SECTION 5 FUEL SYSTEM AND GOVERNOR

Adjustment

NOTE: Carburetor adjustments should be made only after the engine has warmed up.

The carburetor is designed to deliver the correct fuel-to-air mixture to the engine under all operating conditions. The main fuel jet (power screw) is calibrated at the factory and is adjustable. The idle fuel adjusting needle is also set at the factory and normally does not need adjustment.

If the engine is hard-starting or runs roughly or stalls at low idle speed, it may be necessary to adjust or service the carburetor.

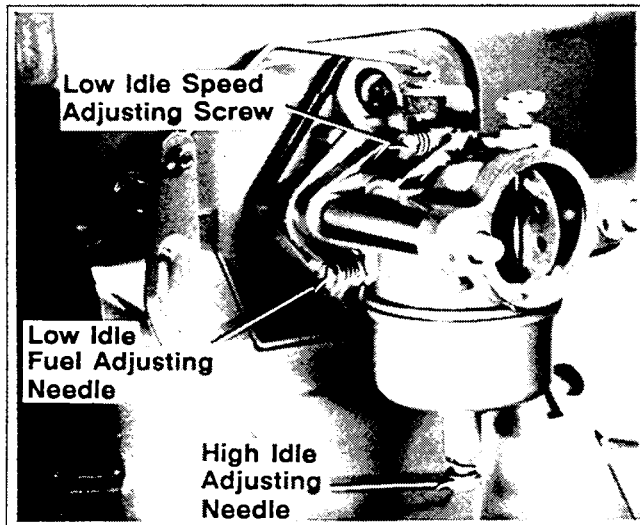

Figure 5-2. Adjustable Main Jet Carburetor.

Adjust Carburetor

1. With the engine stopped turn the low and high idle fuel adjusting needles in **(clockwise)** until they bottom **lightly**.

NOTE: The tip of the idle fuel and high idle fuel adjusting needles are tapered to critical dimensions. Damage to the needles and the seats in carburetor body will result if the needles are forced.

2. **Preliminary settings:** Turn the adjusting needles out **(counterclockwise)** from lightly bottomed to the positions shown in the chart.

TURNS			
	CH11	CH12.5	CH14
IDLE	1-1/4	1-1/4	1-3/4
HIGH SPEED	1-1/2	1-1/2	1-1/4

3. Start the engine and run at half-throttle for 5 to 10 minutes to warm up. The engine must be warm before making final settings. Check that the throttle and choke plates can fully open.
4. **High idle fuel needle setting:** Place the throttle into the "fast" position. If possible place the engine under load. Turn the high idle fuel adjusting needle in (slowly) until engine speed decreases and then back out approximately 1/4 turn for best high-speed performance.
5. **Low idle speed setting:** Place the throttle control into the "idle" or "slow" position. Set the low idle speed to 1500 rpm and $*(\pm 75 \text{ rpm})$ by turning the low idle speed adjusting screw in or out. Check the speed using a tachometer.

*NOTE: The actual low idle speed depends on the application — refer to equipment manufacturer's recommendations. The recommended low idle speed for basic engines is 1500 rpm. To ensure best results when setting the low idle fuel needle the low idle speed should not exceed 1500 rpm ($\pm 75 \text{ rpm}$).

6. **Low idle fuel needle setting:** Place the throttle into the "idle" or "slow" position. Turn the low idle fuel adjusting needle in (slowly) until engine speed decreases and then back out approximately 1/8 to 1/4 turn to obtain the best low speed performance.
7. Recheck the idle speed using a tachometer. Readjust the speed as necessary.

SECTION 5 FUEL SYSTEM AND GOVERNOR

Disassembly

1. Remove the power screw, needle and spring, main jet, power screw gasket and fuel bowl.
2. Remove the bowl gasket, float shaft, float, and fuel inlet needle.

3. Remove the low idle fuel adjusting needle and spring. Remove the low idle speed adjusting screw and spring.

Further disassembly to remove the welch plug, fuel inlet seat, throttle plate and shaft, and choke plate and shaft is recommended only if these parts are to be cleaned or replaced.

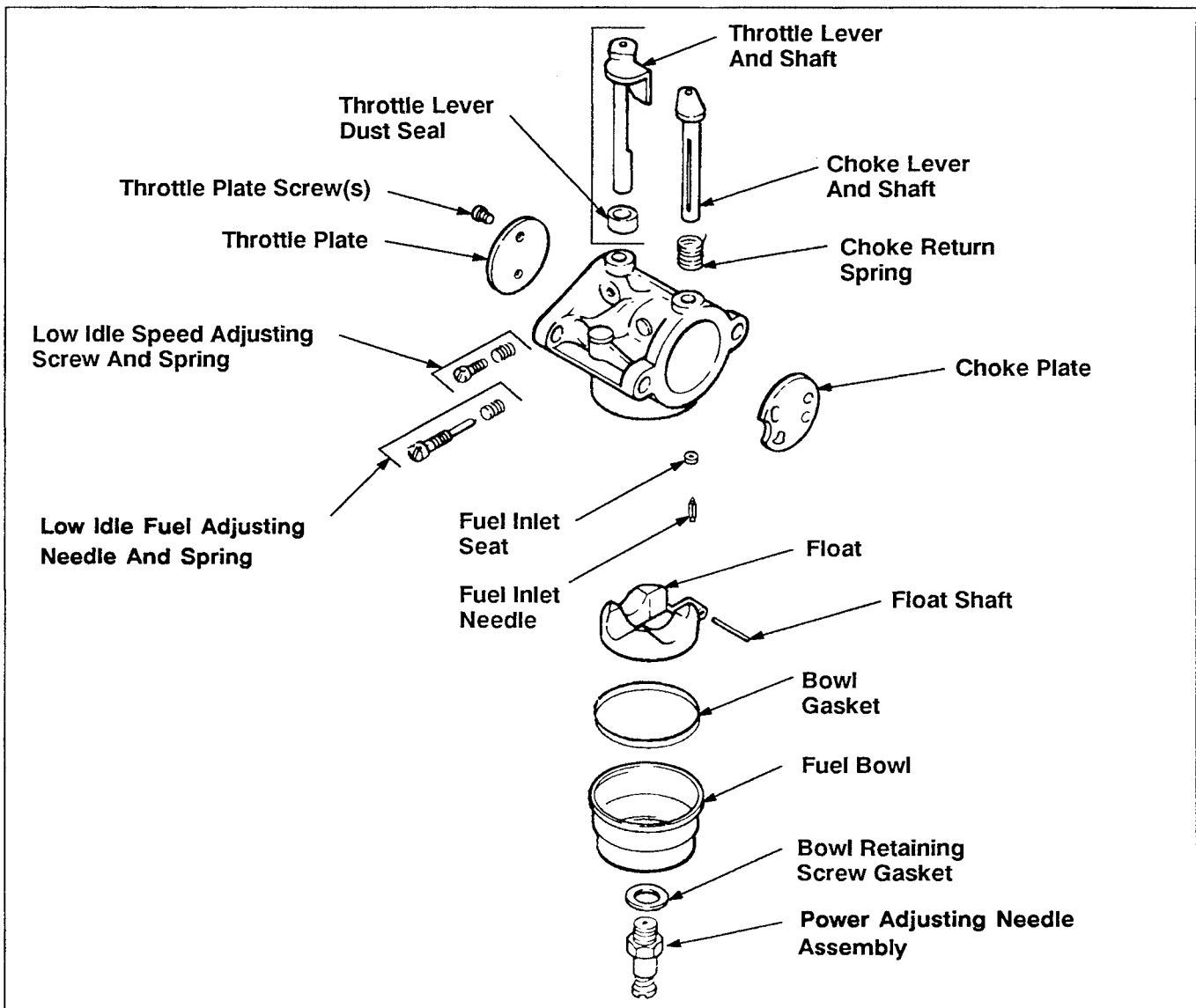

Figure 5-3. Carburetor – Exploded View.

SECTION 5 FUEL SYSTEM AND GOVERNOR

Welch Plug Removal

In order to clean the "off-idle" ports and bowl vent thoroughly, remove the welch plug covering these areas.

Use tool no. **KO-1018** and the following procedure to remove the welch plug. See Figure 5-4.

1. Pierce the welch plug with the tip of the tool.

NOTE: To prevent damage to the carburetor, do not allow the tool to strike the carburetor body.

2. Pry out the welch plug with the tip of the tool.

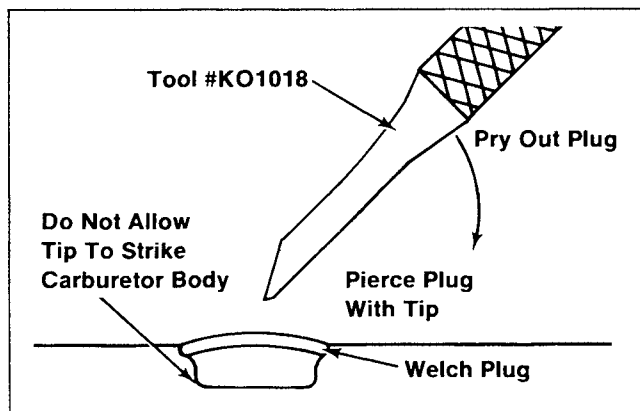

Figure 5-4. Removing Welch Plug.

Fuel Inlet Seat Removal

To remove the fuel inlet seat, pull it out of the carburetor body using a screw, drill bit, or similar tool.

NOTE: Always install a new fuel inlet seat. Do not reinstall a seat that has been removed.

Choke Shaft Removal

1. Because the edges of the choke plate are beveled, mark the choke plate and carburetor body to ensure correct reassembly. See Figure 5-5.

Also take note of the choke plate position in bore, and the position of the choke lever and choke return spring.

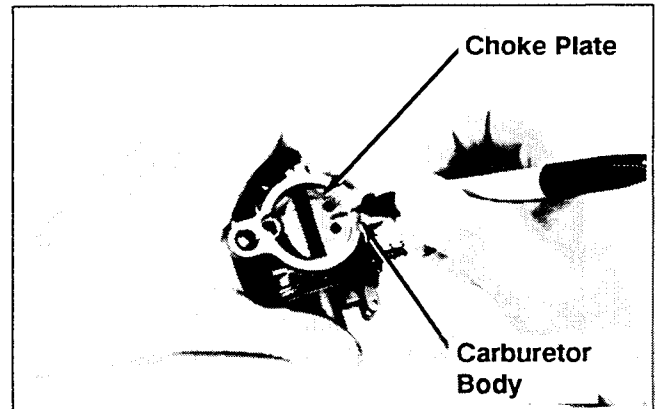

Figure 5-5. Marking Choke Plate And Carburetor Body.

2. Grasp the choke plate with a pliers. Pull it out of the slot in the choke shaft. See Figure 5-6.

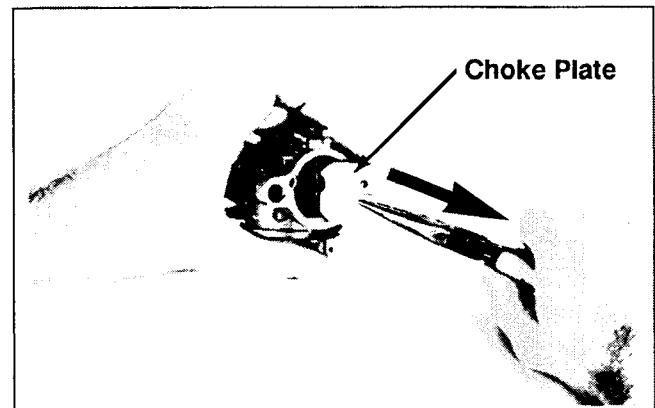

Figure 5-6. Removing Choke Plate.

3. Remove the choke shaft and choke return spring.

Throttle Shaft Removal

1. Because the edges of the throttle plate are beveled, mark the throttle plate and carburetor body to ensure correct reassembly.

Also take note of the throttle plate position in bore, and the position of the throttle lever.

2. Carefully and slowly remove the screws securing the throttle plate to the throttle shaft. Remove the throttle plate.
3. File off any burrs which may have been left on the throttle shaft when the screws were removed. Do this **before** removing the throttle shaft from the carburetor body.

SECTION 5 FUEL SYSTEM AND GOVERNOR

4. Remove the throttle lever/shaft assembly with foam dust seal.

Cleaning

WARNING: Flammable Solvents!



Carburetor cleaners and solvents are extremely flammable. Keep sparks, flames, and other sources of ignition away from the area. Follow the cleaner manufacturer's warnings and instructions on its proper and safe use. Never use gasoline as a cleaning agent.

All parts should be cleaned thoroughly using a carburetor cleaner (such as acetone). Make sure all gum deposits are removed from the following areas:

- **Carburetor body and bore;** especially the areas where the throttle plate, choke plate and shafts are seated.
- **Idle fuel and "off-idle" ports in carburetor bore, power screw, bowl vent, and fuel inlet needle and seat.**

NOTE: These areas can be cleaned with a piece of fine wire in addition to cleaners. Be careful not to enlarge the ports, or break the wire inside the ports. Blow out all passages with compressed air.

- **Float and float hinge.**
- **Fuel bowl.**
- **Throttle plate, choke plate, throttle shaft, and choke shaft.**

NOTE: Do not submerge the carburetor in cleaner or solvent when fiber, rubber, or foam seals or gaskets are installed. The cleaner may damage these components.

Inspection

Carefully inspect all components and replace those that are worn or damaged.

- Inspect the carburetor body for cracks, holes, and other wear or damage.
- Inspect the float for cracks, holes, and missing or damaged float tabs. Check the float hinge and shaft for wear or damage.
- Inspect the fuel inlet needle and seat for wear or damage.
- Inspect the tip of the low idle fuel adjusting needle and power screw needle for wear or grooves.
- Inspect the throttle and choke shaft and plate assemblies for wear or excessive play.

Repair

Always use new gaskets when servicing or reinstalling carburetors. Repair kits are available which include new gaskets and other components. These kits are described below.

Components such as the throttle and choke shaft assemblies, throttle plate, choke plate, low idle fuel needle, power screw, and others, are available separately.

Always refer to the Parts Manual for the engine being serviced to ensure the correct repair kits and replacement parts are ordered.

Carburetor Repair Kit Contains:

Qty.	Description
1	Heat Deflector Gasket
1	Air Cleaner Base Gasket
1	Bowl Gasket
1	Bowl Retainer Gasket
1	Welch Plug
1	Fuel Inlet Needle Valve
1	Fuel Inlet Valve Seat

SECTION 5 FUEL SYSTEM AND GOVERNOR

Float Assembly Kit Contains:

Qty.	Description
1	Float Assembly
1	Float Shaft

Adjustable Power Screw Kit Contains:

Qty.	Description
1	Power Screw Assembly
1	Bowl Retainer Gasket

Reassembly

Throttle Shaft Installation

1. Install the foam dust seal on the throttle shaft.
2. Insert the throttle lever/shaft assembly into the carburetor body. Position the cutout portion of the shaft so it faces the carburetor mounting flange.
3. Install the throttle plate to the throttle shaft. Make sure the plate is positioned properly in the bore as noted and marked during disassembly. Apply **Loctite® no. 609** to the threads of the throttle plate retaining screws. Install the screws so they are slightly loose.

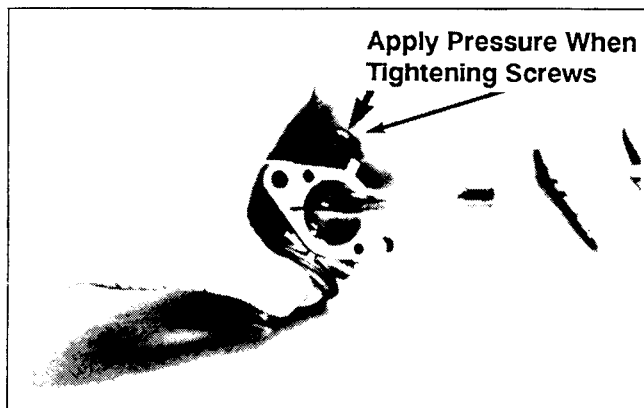

Figure 5-7. Installing The Throttle Lever/Shaft.

4. Apply finger pressure to the throttle lever/shaft to keep it firmly seated against the pivot in the carburetor body. Rotate the throttle shaft until the throttle plate closes the bore around its entire perimeter; then tighten the screws. See Figure 5-7.
5. Operate the throttle lever. Check for binding between the throttle plate and carburetor bore. Loosen the screws and adjust the throttle plate as necessary.

Torque the screws to **0.9/1.4 N•m (8/12 lbf•in)**.

Choke Shaft Installation

1. Install the choke return spring to the choke shaft.
2. Insert the choke lever with return spring into the carburetor body.
3. Rotate the choke lever approximately 1/2 turn **counterclockwise**. Make sure the choke return spring hooks on the carburetor body.
4. Position the choke plate as noted and marked during disassembly. Insert the choke plate into the slot in the choke shaft. Make sure the choke shaft is locked between the tabs on the choke plate.

Fuel Inlet Seat Installation

Press the fuel inlet seat into the bore in carburetor body until it bottoms.

Welch Plug Installation

Use tool no. KO-1017 and install new plugs as follows:

1. Position the carburetor body with the welch plug cavity to the top.
2. Place a new welch plug into the cavity with the raised surface **up**.
3. Use the end of the tool that is about the same size as the plug and **flatten** the plug. Do not force the plug below the surface of the cavity. See Figure 5-8.

SECTION 5 FUEL SYSTEM AND GOVERNOR

4. After the plug is installed, seal it with glyptal (or an equivalent sealant). Allow the sealant to dry.

NOTE: If a commercial sealant is not available, fingernail polish can be used.

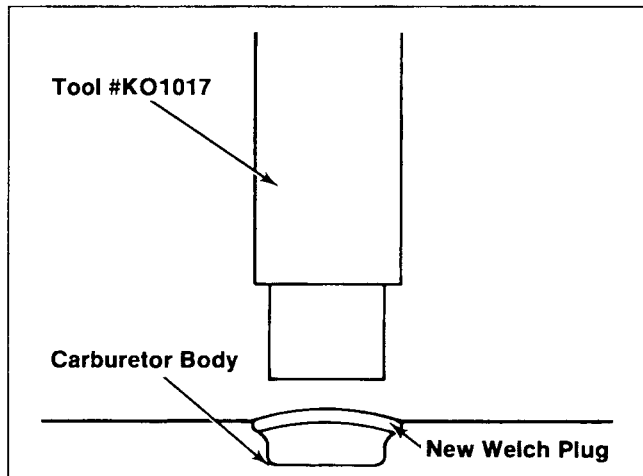

Figure 5-8. Installing Welch Plug.

Carburetor Reassembly

1. Install the low idle speed adjusting screw and spring.
2. Install the low idle fuel adjusting needle and spring. Turn the adjusting needle in (**clockwise**) until it bottoms *lightly*.

NOTE: The tip of the idle fuel adjusting needle is tapered to critical dimensions. Damage to the needle and the seat in carburetor body will result if the needle is forced.

3. Turn the low idle fuel adjusting needle out (**counterclockwise**) as specified in the "Adjustment" portion of this section.
4. Insert the fuel inlet needle into the float. Lower the float/needle into the carburetor body. See Figure 5-9.

Install the float shaft.

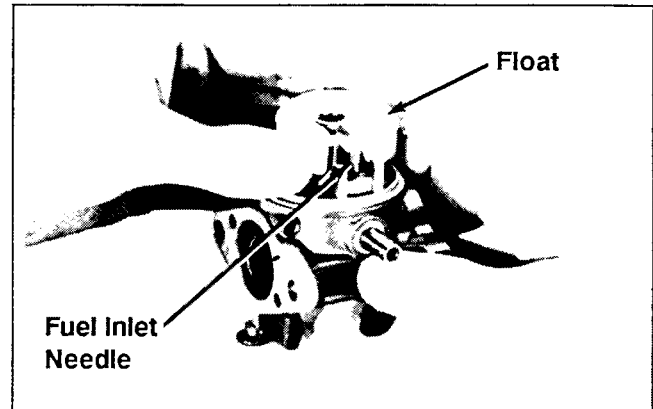

Figure 5-9. Installing Float And Fuel Inlet Needle.

5. Install the bowl gasket, fuel bowl, bowl retainer gasket, and power screw.

Torque the power screw to: **5.1/6.2 N•m (45/55 lbf•in)**.

High Altitude Operation

When operating the engine at altitudes of 1830 m (6000 ft) and above, the main fuel mixture tends to get overrich. An overrich mixture can cause conditions such as black, sooty exhaust smoke, misfiring, loss of speed and power, poor fuel economy, and poor or slow governor response.

To compensate for the effects of high altitude, a special high altitude main fuel jet can be installed. High altitude jets are sold in kits which include the jet and necessary gaskets. Refer to the Parts Manual for the engine being serviced for the correct kit number.

GOVERNOR

These engines are equipped with a centrifugal flyweight mechanical governor. It is designed to hold the engine speed constant under changing load conditions. The governor gear/flyweight mechanism is mounted inside the crankcase and is driven off the gear on the camshaft.

Operation

Centrifugal force acting on the rotating governor gear assembly causes the flyweights to move outward as

speed increases and inward as speed decreases. As the flyweights move outward, they cause the regulating pin to move outward.

The regulating pin contacts the tab on the cross shaft, causing the shaft to rotate when the engine speed changes. One end of the cross shaft protrudes through the side of the crankcase. Through external linkage attached to the cross shaft, the rotating action is transmitted to the throttle lever of the carburetor.

When the engine is at rest, and the throttle is in the "fast" position, the tension of the governor spring holds the throttle plate open. When the engine is operating (the governor gear assembly is rotating), the force applied by the regulating pin against the cross shaft tends to close the throttle plate. The governor spring tension and the force applied by the regulating pin are in "equilibrium" during operation, holding the engine speed constant.

When load is applied and the engine speed (and governor gear speed) decreases, the governor spring tension moves the governor arm to open the throttle plate wider. This allows more fuel into the engine; increasing engine speed. (This action takes place very rapidly, so a reduction in speed is hardly noticed.) As the speed reaches the governed setting, the governor spring tension and the force applied by the regulating pin will again be in equilibrium. This maintains the engine speed at a relatively constant level.

The governed speed setting is determined by the position of the throttle control. It can be variable or constant, depending on the application.

Initial Adjustment

Make this initial adjustment whenever the governor arm is loosened or removed from the cross shaft. To ensure proper setting, make sure the throttle linkage is connected to the governor arm and the throttle lever on the carburetor. See Figure 5-10.

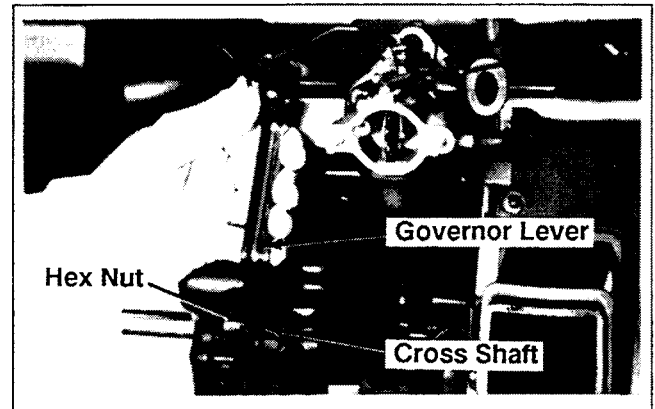

Figure 5-10. Initial Governor Adjustment.

1. Pull the governor lever away from the carburetor (wide open throttle).
2. Insert a nail in the cross shaft hole or grasp the cross shaft with a pliers and turn the shaft **counterclockwise** as far as it will go.
3. Tighten the hex nut securely.

Sensitivity Adjustment

Governor sensitivity is adjusted by repositioning the governor spring in the holes in the governor lever. If speed surging occurs with a change in load, the governor is set too sensitive. If a big drop in speed occurs when normal load is applied, the governor should be set for greater sensitivity.

SECTION 5

FUEL SYSTEM AND GOVERNOR

Remote Throttle and Choke Adjustment

1. Adjust the throttle lever. See this section.
2. Install remote throttle cable in hole in the throttle lever. See Figure 5-11.

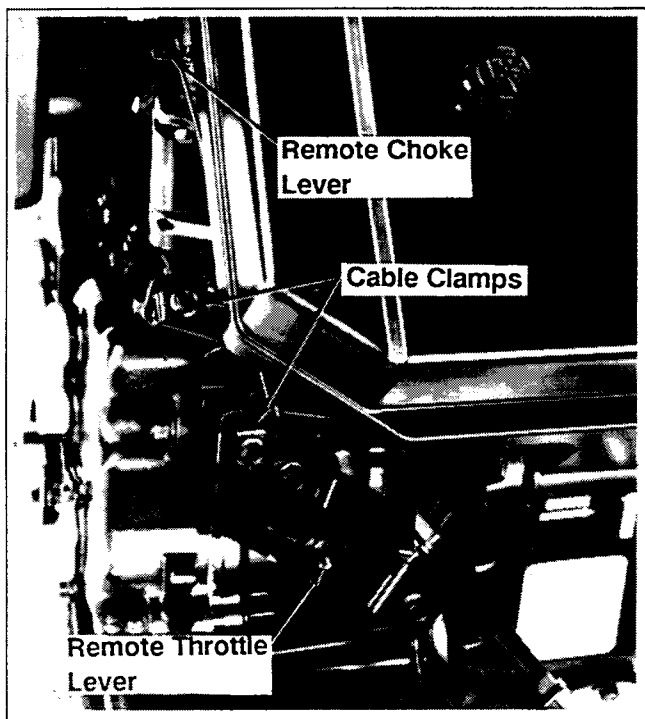

Figure 5-11. Remote Throttle And Choke Adjustment.

3. Install remote choke cable in hole in the choke lever.
4. Secure remote cables loosely with the cable clamps.
5. Position the throttle cable so that the throttle lever is against stop.
6. Tighten the throttle cable clamp.
7. Position the choke cable so that the carburetor choke plate is fully closed.
8. Tighten the choke cable clamp.
9. Check carburetor idle speed. See Adjust Carburetor in this section.

SECTION 6 LUBRICATION SYSTEM

OIL RECOMMENDATIONS

Using the proper type and weight of oil in the crankcase is extremely important. So is checking oil daily and changing oil regularly. Failure to use the correct oil, or using dirty oil, causes premature engine wear and failure.

Oil Type

Use high-quality detergent oil of API (American Petroleum Institute) service class SF or SG. Select the viscosity based on the air temperature at the time of operation as shown in the following table.

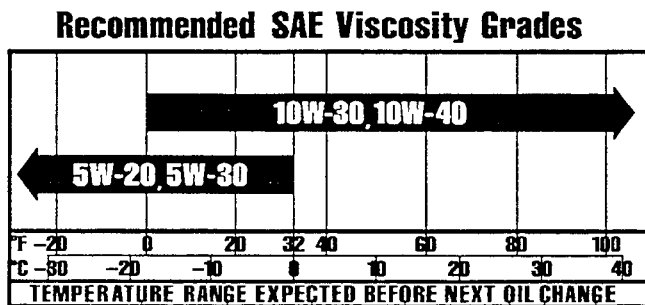

NOTE: Using other than service class SF or SG oil or extending oil change intervals longer than recommended can cause engine damage.

A logo or symbol on oil containers identifies the API service class and SAE viscosity grade. See Figure 6-1.



Figure 6-1. Oil Container Logo.

CHECK OIL LEVEL

The importance of checking and maintaining the proper oil level in the crankcase cannot be overemphasized. Check oil **BEFORE EACH USE** as follows:

1. Make sure the engine is stopped, level, and is cool so the oil has had time to drain into the sump.
2. To keep dirt, grass clippings, etc., out of the engine, clean the area around the oil fill cap/dipstick before removing it.
3. Remove the oil fill cap/dipstick; wipe oil off. Reinsert the dipstick into the tube and seat the oil fill cap on the tube. See Figure 6-2.

SECTION 6 LUBRICATION SYSTEM



Figure 6-2. Checking Oil Level.

4. Remove the dipstick and check the oil level.

The oil level should be up to, but not over, the "F" mark on the dipstick. See Figure 6-3.

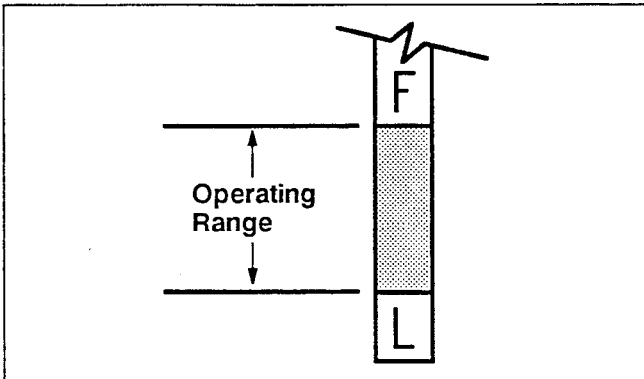

Figure 6-3. Oil Level Dipstick.

5. If the level is low, add oil of the proper type, up to the "F" mark on the dipstick. Always check the level with the dipstick before adding more oil.

NOTE: To prevent extensive engine wear or damage, always maintain the proper oil level in the crankcase. Never operate the engine with the oil level below the "L" mark or over the "F" mark on the dipstick.

Oil Sentry™

Some engines are equipped with an optional Oil Sentry oil pressure monitor. If the oil pressure gets low, Oil

Sentry will either shut off the engine or activate a warning signal, depending on the application.

NOTE: Make sure the oil level is checked **BEFORE EACH USE** and is maintained up to the "F" mark on the dipstick. This includes engines equipped with Oil Sentry.

CHANGE OIL AND OIL FILTER

Change Oil

For a new engine, change oil after the first **5 hours** of operation. Thereafter, change oil after every **100 hours** of operation.

For an overhauled engine or those rebuilt with a new short block, use *10W-30-weight* service class SF oil for the first **5 hours** of operation. Change the oil after this initial run-in period. Refill with service class SF oil as specified in the "Viscosity Grades" table.

Change the oil while the engine is still warm. The oil will flow freely and carry away more impurities. Make sure the engine is level when filling, checking, and changing the oil.

Change the oil as follows (see Figure 6-4):

1. Remove the oil drain plug and oil fill cap/dipstick. Be sure to allow ample time for complete drainage.
2. Reinstall the drain plug. Make sure it is tightened to **13.6 N·m (10 lbf·ft)** torque.
3. Fill the crankcase, with new oil of the proper type, to the "F" mark on the dipstick. Always check the level with the dipstick before adding more oil.
4. Reinstall the oil fill cap/dipstick.

NOTE: To prevent extensive engine wear or damage, always maintain the proper oil level in the crankcase. Never operate the engine with the oil level below the "L" mark or over the "F" mark on the dipstick.

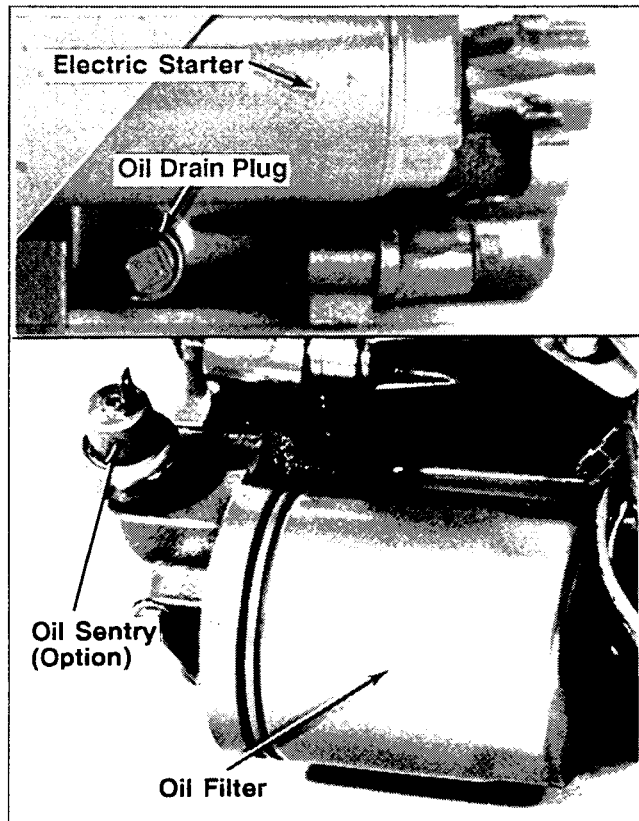

Figure 6-4. Oil Drain Plug (Starter Side Shown, Also Located Behind Oil Filter), Oil Filter, And Optional Oil Sentry Switch.

Change Oil Filter

Replace the oil filter **every other oil change (every 200 hours of operation)**. Always use a genuine Kohler oil filter.

Replace the oil filter as follows:

1. Drain the oil from the engine crankcase.
2. Allow the oil filter to drain.
3. Remove the old filter and wipe off the filter adapter.
4. Apply a thin coating of new oil to the rubber gasket on the replacement oil filter.
5. Install the replacement oil filter to the filter adapter. Turn the oil filter clockwise until the rubber gasket contacts the filter adapter, then tighten the filter an additional **1/2 turn**.

6. Reinstall the drain plug. Torque the drain plug to **7.3/9.0 N·m (65/80 lbf·in)**.

7. Fill the crankcase with new oil as instructed under "Change Oil." Add an additional 0.24 L (1/2 pint) of oil for the filter capacity.

8. Start the engine and check for oil leaks. Correct any leaks before placing the engine into service.

FULL PRESSURE LUBRICATION SYSTEM

Operation

This engine uses a full-pressure lubrication system. This system delivers oil, under pressure, to the crankshaft, camshaft, balance shaft, and connecting rod bearing surfaces. In addition to lubricating the bearing surfaces, the lubrication system operates the hydraulic valve lifters.

A high efficiency gerotor oil pump is located in the closure plate and is driven directly by the balance shaft. The oil pump maintains high oil flow and oil pressure, even at low speeds and high operating temperatures. A pressure relief valve in the closure plate limits the maximum pressure of the system.

For a cold engine at start up, the oil pressure can go up to 60 psig. For a warm (normal operating temperature) engine at idle speed, the oil pressure can go down to 12 psig.

Service

The oil pump rotors can be serviced without removing the closure plate. Remove the oil pump cover on the PTO side of closure plate to service the rotors.

The closure plate must be removed to service the oil pickup and oil pressure relief valve.

See Figures 6-5, 6-6, and 6-7. Also refer to the "Disassembly" and "Reassembly" sections for lubrication system components removal and installation procedures.

SECTION 6 LUBRICATION SYSTEM

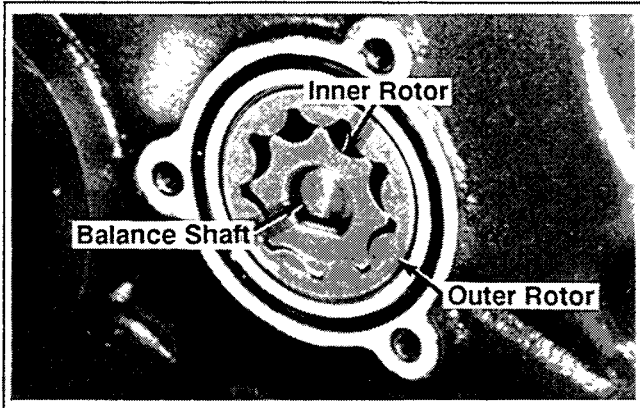

Figure 6-5. Gerotor Oil Pump.

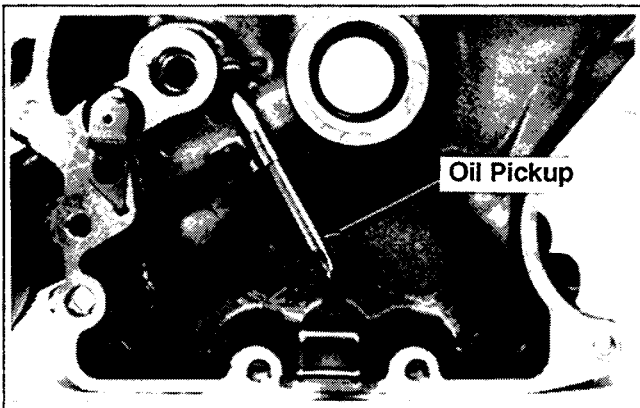

Figure 6-6. Oil Pickup.

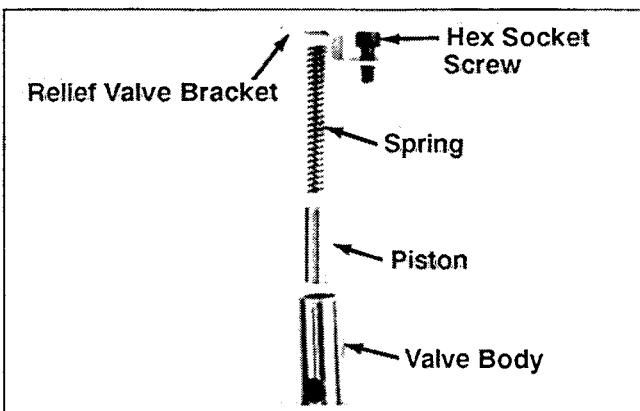

Figure 6-7. Oil Pressure Relief Valve Components.

OIL FILTER

These engines are equipped with a full-flow oil filter. See Figure 6-8.

The oil filter helps remove sludge and other combustion by-products from the oil. It also extends the oil change interval and cools the oil.

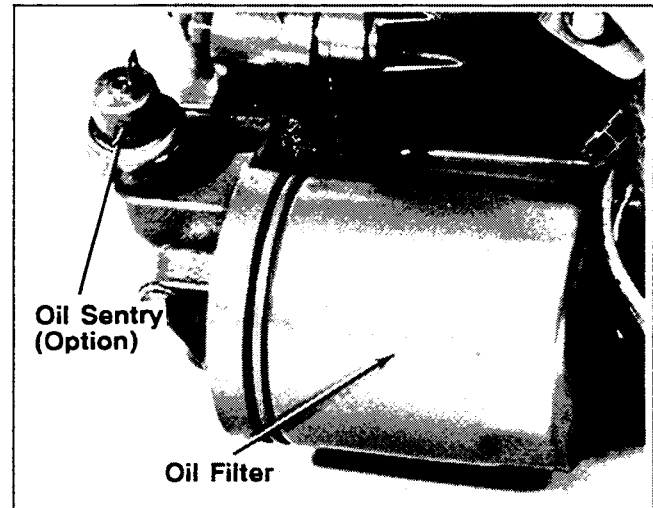

Figure 6-8. Oil Filter And Oil Sentry™.

OIL SENTRY™ OIL PRESSURE MONITOR

Some engines are equipped with an optional Oil Sentry oil pressure monitor. See Figure 6-8. Oil Sentry will either stop the engine or activate a "low oil" warning light, if the oil pressure gets low. Actual Oil Sentry use will depend on the engine application.

Operation

The pressure switch is designed to break contact as the oil pressure increases and make contact as the oil pressure decreases. At oil pressures above approx. 3.0 to 5.0 psig., the switch contacts open. At oil pressures below approx. 3.0 to 5.0 psig., the switch contacts close.

On stationary or unattended applications (pumps, generators, etc.), the pressure switch can be used to ground the ignition module to stop the engine.

On vehicular applications (lawn tractors, mowers, etc.), the pressure switch can be used to activate a "low oil" warning light.

NOTE: Oil Sentry is not a substitute for checking the oil level **BEFORE EACH USE**. Make sure the oil level is maintained up to the "F" mark on the dipstick.

Installation

The pressure switch is installed in the oil filter adapter, in one of the main oil galleries of the closure plate (see Figure 6-8). On engines not equipped with Oil Sentry, the installation hole is sealed with a 1/8-27 N.P.T.F. pipe plug.

To install the Oil Sentry switch to the oil filter adapter of closure plate:

1. Apply **Loctite® #592 pipe sealant with teflon** (or equivalent) to the threads of the switch.
2. Install the switch into the tapped hole in oil filter adapter.
- Torque the switch to **7.9 N·m (70 lbf·in)**.

Testing

The Oil Sentry pressure monitor is a normally closed type switch. It is calibrated to open (break contact) with increasing pressure and close (make contact) with decreasing pressure within the range of 3.0/5.0 psig.

Compressed air, a pressure regulator, pressure gauge, and a continuity tester are required to test the switch.

1. Connect the continuity tester across the blade terminal and the metal case of switch. With **0 psig** pressure applied to the switch, the tester should indicate **continuity (switch closed)**.
2. Gradually *increase* the pressure to the switch. The tester should indicate a change to **no continuity (switch open)** as the pressure increases through the range of **3.0/5.0 psig**.

The switch should remain open as the pressure is increased to **90 psig maximum**.

3. Gradually *decrease* the pressure to the switch. The tester should indicate a change to **continuity (switch closed)** as the pressure decreases through the range of **3.0/5.0 psig; approaching 0 psig**.

If the switch does not operate as specified, replace the switch.



SECTION 7

RETRACTABLE STARTER

CAUTION: Spring Under Tension!



Retractable starters contain a powerful, flat wire recoil spring that is under tension. Do not remove the center screw from the starter until the spring tension is released. Removing the center screw before releasing spring tension, or improper starter disassembly, can cause the sudden and potentially dangerous release of the spring.

Always wear safety goggles when servicing retractable starters – full face protection is recommended.

To ensure personal safety and proper starter disassembly and reassembly, follow the procedures in this section carefully.

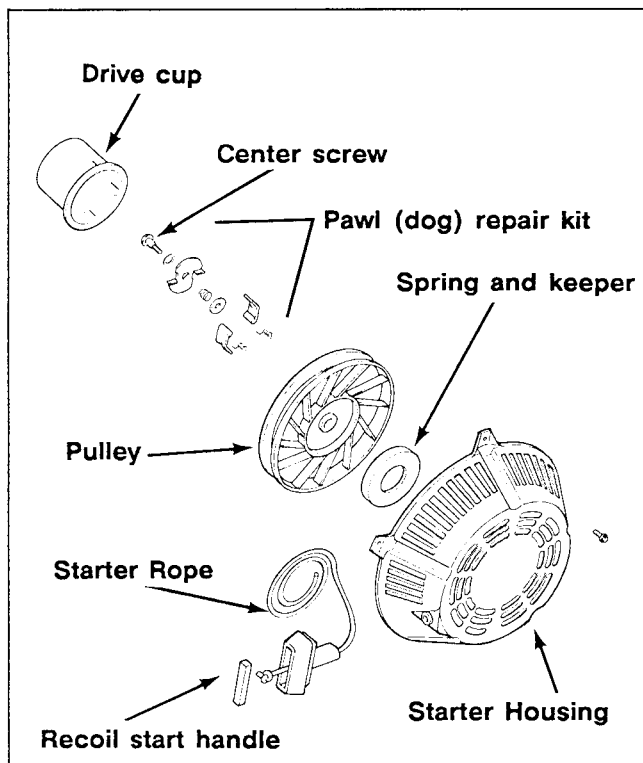

Figure 7-1. Retractable Starter – Exploded View.

TO REMOVE STARTER

1. Remove the five hex flange screws securing the starter to blower housing.
2. Remove the starter.

TO INSTALL STARTER

1. Install the retractable starter and five hex flange screws to blower housing. Leave the screws slightly loose.
2. Pull the starter handle out until the pawls engage in the drive cup. Hold the handle in this position and tighten the screws securely. See Figure 7-2.

SECTION 7 RETRACTABLE STARTER

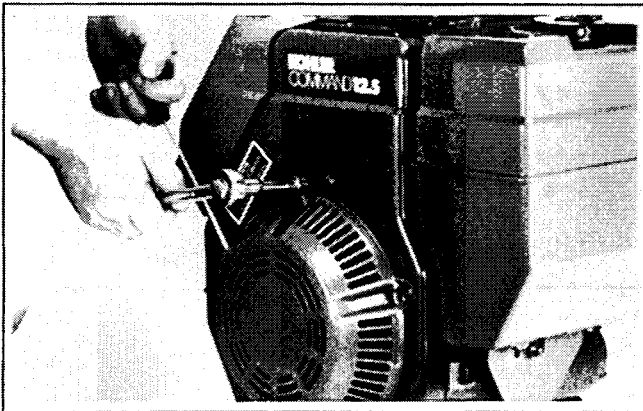

Figure 7-2. Installing Retractable Starter.

ROPE REPLACEMENT

The rope can be replaced *without* complete starter disassembly.

1. Remove the starter from the engine blower housing.
2. Pull the rope out approx. 12" and tie a temporary (slip) knot in it to keep it from retracting into the starter. See Figure 7-3.

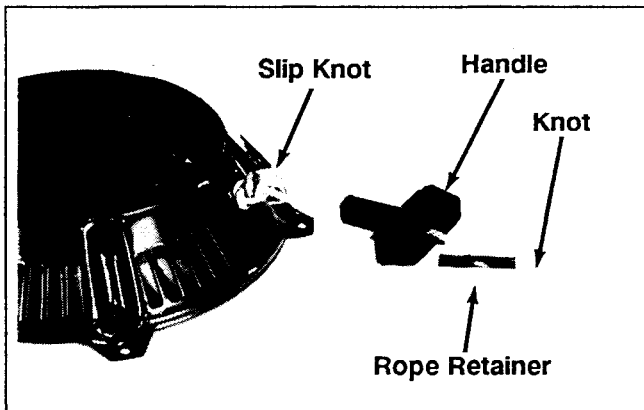

Figure 7-3. Removing Starter Handle.

3. Remove the rope retainer from inside the starter handle. Untie the single knot and remove the rope retainer and handle.
4. Hold the pulley firmly and untie the slip knot. Allow the pulley to rotate slowly as the spring tension is released.

5. When all spring tension on the starter pulley is released, remove the rope from pulley.
6. Tie a single knot in one end of the new rope.
7. Rotate the pulley counterclockwise (when viewed from pawl side of pulley) until the spring is tight. (Approx. 6 full turns of pulley.)
8. Rotate the pulley clockwise until the rope hole in pulley is aligned with rope guide bushing of starter housing.

NOTE: Do not allow the pulley/spring to unwind. Enlist the aid of a helper if necessary, or use a C-clamp to hold the pulley in position.

9. Insert the new rope through the rope hole in starter pulley and rope guide bushing of housing. See Figure 7-4.

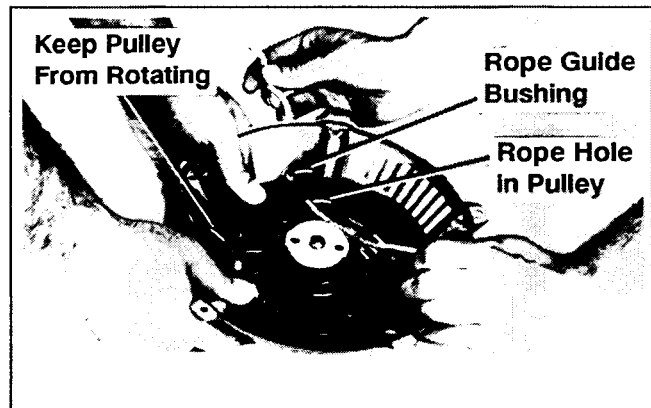

Figure 7-4. Installing Rope.

10. Tie a slip knot approx. 12" from the free end of rope. Hold the pulley firmly and allow it to rotate slowly until the slip knot reaches the guide bushing of housing.
11. Slip the handle and rope retainer onto the rope. Tie a single knot at the end of the rope. Install the rope retainer into the starter handle.
12. Untie the slip knot and pull on the handle until the rope is fully extended. Slowly retract the rope into the starter.

When the spring is properly tensioned, the rope will retract fully and the handle will stop against the starter housing.

PAWLS (DOGS) REPLACEMENT

The starter must be completely disassembled to replace the starter pawls. A pawl repair kit is available which includes the following components:

Pawl Repair Kit Contains:

Qty.	Description
1	Pawl Retainer
1	Center Screw
2	Pawl (Dog) Spring
1	Brake Spring
2	Starter Pawl (Dog)
1	Brake Washer
1	Washer

DISASSEMBLY

CAUTION: Spring Under Tension!



Do not remove the center screw from starter until the spring tension is released. Removing the center screw before releasing spring tension, or improper starter disassembly, can cause the sudden and potentially dangerous release of the spring. Follow these instructions carefully to ensure personal safety and proper starter disassembly. Make sure adequate face protection is worn by all persons in the area.

1. Release spring tension and remove the handle and starter rope. (Refer to "Rope Replacement", steps 2 through 5 above.)
2. Remove the center screw, washer, and pawl retainer. See Figure 7-5.
3. Remove the brake spring and brake washer. See Figure 7-6.
4. Carefully note the positions of the pawls and pawl springs before removing them.

Remove the pawls and pawl springs from the starter pulley.

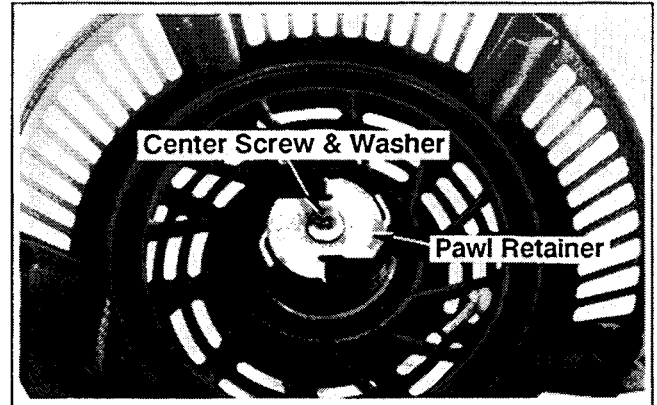

Figure 7-5. Center Screw, Washer And Pawl Retainer.

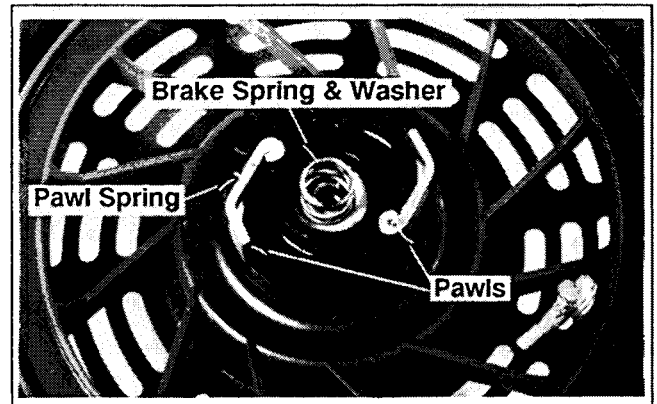

Figure 7-6. Brake Spring And Washer, Pawls, And Pawl Springs.

5. Rotate the pulley **clockwise 2 full turns**. This will ensure the spring is disengaged from the starter housing.
6. Hold the pulley into the starter housing. Invert the pulley/housing so the pulley is away from your face, and away from others in the area.
7. Rotate the pulley slightly from side to side and carefully separate the pulley from the housing. See Figure 7-7.

If the pulley and the housing do not separate easily, the spring could be engaged in the starter housing, or there is still tension on the spring. Return the pulley to the housing and repeat step 5 before separating the pulley and housing.

SECTION 7 RETRACTABLE STARTER

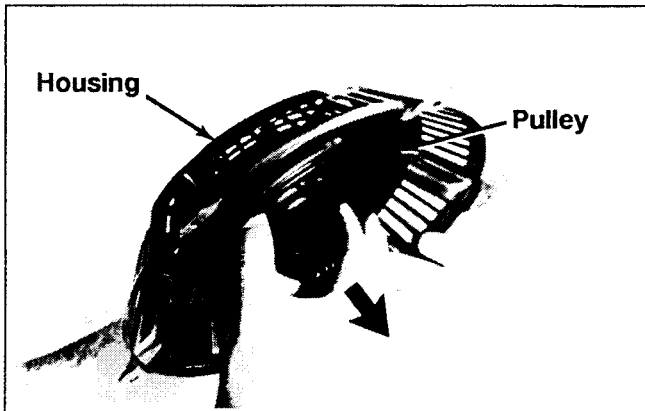

Figure 7-7. Removing Pulley From Housing.

8. Note the position of the spring and keeper assembly in the pulley. See Figure 7-8.

Remove the spring and keeper assembly from the pulley as a package.

CAUTION: Spring Under Tension!



Do not remove the spring from the keeper. Severe personal injury could result from the sudden uncoiling of the spring.

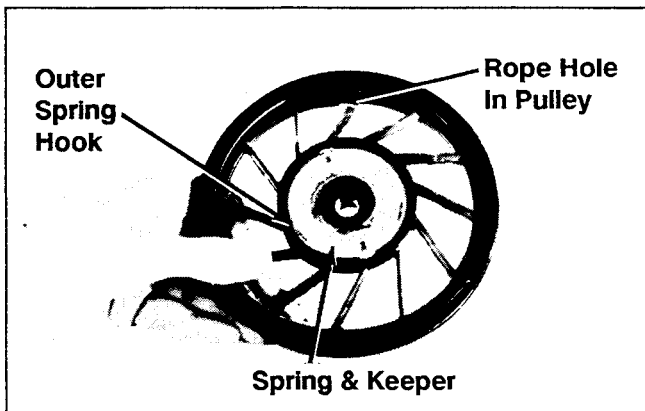

Figure 7-8. Position Of Spring And Keeper In Pulley.

2. Replace all worn or damaged components. Use only genuine Kohler replacement parts as specified in the Parts Manual. All components shown in Figure 7-1. are available as service parts. Do not use nonstandard parts.
3. Do not attempt to rewind a spring that has come out of the keeper. Order and install a new spring and keeper assembly.
4. Clean all old grease and dirt from the starter components. Generously lubricate the spring and center shaft with any commercially available bearing grease.

REASSEMBLY

1. Make sure the spring is well lubricated with grease. Place the spring and keeper assembly inside the pulley (with spring towards pulley). See Figure 7-8.
2. Install the pulley with spring and keeper assembly into the starter housing. See Figure 7-9.

Make sure the pulley is fully seated against the starter housing. Do not wind the pulley and recoil spring at this time.

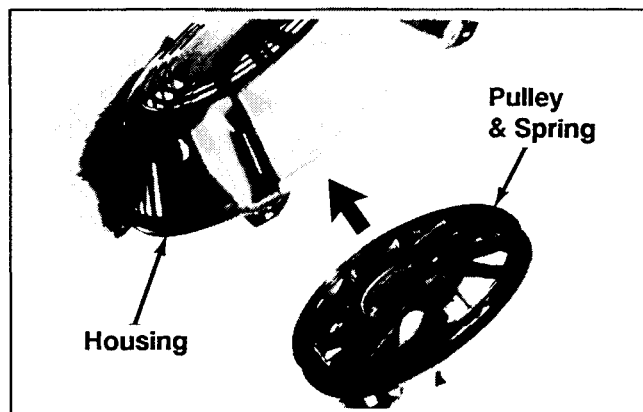

Figure 7-9. Installing Pulley And Spring Into Housing.

INSPECTION AND SERVICE

1. Carefully inspect the rope, pawls, housing, center screw, and other components for wear or damage.
3. Install the pawls springs and pawls into the starter pulley. See Figure 7-10.

SECTION 7 RETRACTABLE STARTER

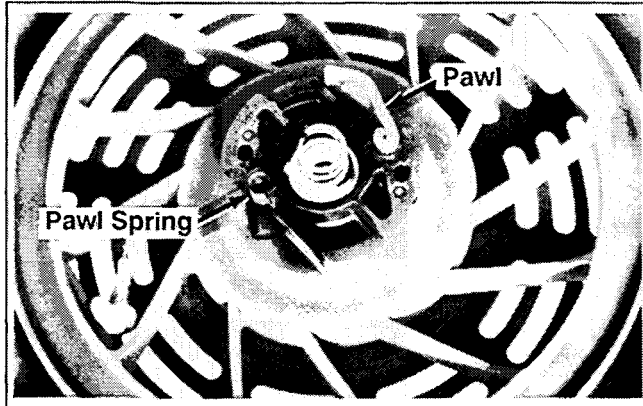

Figure 7-10. Installing Pawls And Pawl Springs.

4. Place the brake washer in the recess in starter pulley; over the center shaft.
5. Lubricate the brake spring sparingly with grease. Place the spring on the plain washer. (Make sure the threads in center shaft remain clean, dry, and free of grease and oil.)
6. Apply a small amount of **Loctite® #271** to the threads of the center screw. Install the center screw, with washer and retainer, to the center shaft. Torque the screw to **7.4/8.5 N·m (65/75 lbf·in)**.
7. Tension the spring and install the rope and handle as instructed in steps 6 through 12 under "Rope Replacement" above.
8. Install the starter to the engine blower housing.

SECTION 8

ELECTRICAL SYSTEM AND COMPONENTS

This section covers the operation, service, and repair of the electrical system and electrical system components.

Major electrical systems and components covered in this section include the spark plug, battery, ignition system and ignition module, battery charging systems, electric starters, and Oil Sentry™ oil pressure switch.

SPARK PLUG

Engine misfire or starting problems are often caused by a spark plug that is in poor condition or with an improper gap setting.

This engine is equipped with the following spark plug:

Type:	Champion® RC12YC (or equivalent)
Gap:	1.02 mm (0.040 in)
Thread Size:	14 mm
Reach:	19.1 mm (3/4 in)
Hex Size:	15.9 mm (5/8 in)

Spark Plug Service

Every **100 hours** of operation, remove the spark plug, check its condition, and reset the gap or replace with a new plug as necessary.

1. Before removing the spark plug, clean the area around the base of the plug to keep dirt and debris out of the engine.
2. Remove the plug and check its condition. Replace the plug if worn or reuse is questionable.

NOTE: Do not clean the spark plug in a machine using abrasive grit. Some grit could remain in the spark plug and enter the engine causing extensive wear and damage.

3. Check the gap using a wire feeler gauge. Adjust the gap to **1.02 mm (0.040 in)** by carefully bending the ground electrode. See Figure 8-1.
4. Reinstall the spark plug into the cylinder head. Torque the spark plug to **38.0/43.4 N·m (28/32 lbf·ft)**.

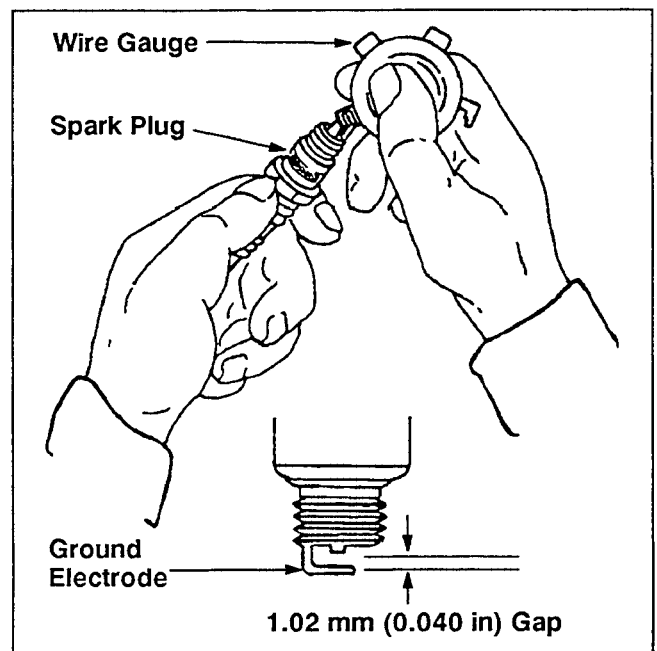

Figure 8-1. Servicing Spark Plug.

SECTION 8 ELECTRICAL SYSTEMS AND COMPONENTS

Inspection

Inspect the spark plug as soon as it is removed from the cylinder head. The deposits on the tip are an indication of the general condition of the piston rings, valves, and carburetor.

Normal and fouled plugs are shown in the following photos.



Normal: A plug taken from an engine operating under normal conditions will have light tan or gray colored deposits. If the center electrode is not worn, a plug in this condition could be regapped and reused.



Carbon Fouled: Soft, sooty, black deposits indicate incomplete combustion. Incomplete combustion is usually caused by overrich carburetion, weak ignition, or poor compression.

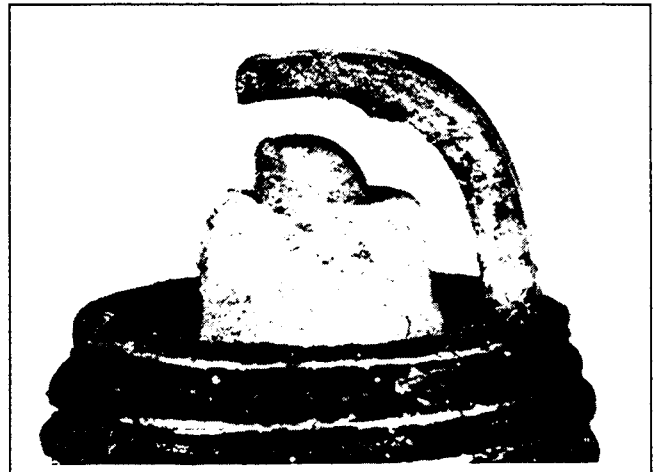

Worn: On a worn plug, the center electrode will be rounded and the gap will be eroded .010" or more than the correct gap. Replace a worn spark plug immediately.

SECTION 8 ELECTRICAL SYSTEMS AND COMPONENTS

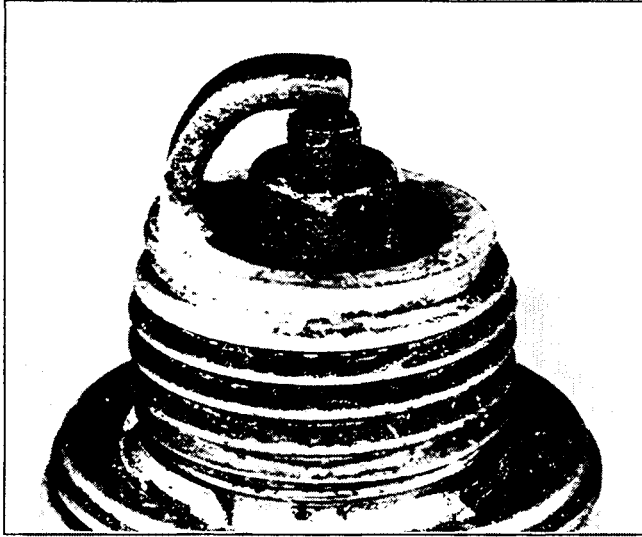

Wet Fouled: A wet plug is caused by excess fuel, or oil in the combustion chamber. Excess fuel could be caused by operating the engine with too much choke. Oil in the combustion chamber is usually caused by worn piston rings or valve guides.

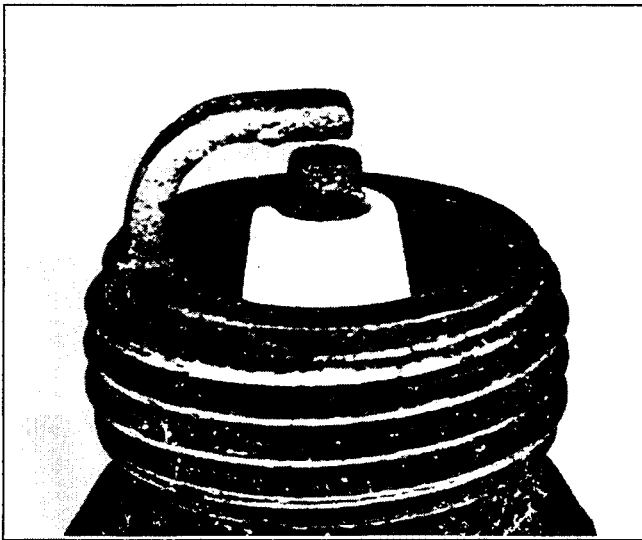

Chalky White Deposits: Chalky white colored deposits indicate overheating. This condition is usually accompanied by excessive gap erosion. A clogged grass screen, clogged cooling fins, and lean carburetion are some causes of overheating.

BATTERY

A 12-volt battery with a rating of approximately 32-amp hours/250 cold cranking amps. is normally used. Refer to the operating instructions of the equipment this engine powers for specific information.

If the battery charge is not sufficient to crank the engine, recharge the battery.

NOTE: Do not attempt to "jump start" the engine with another battery. Starting the engine with batteries larger than those recommended can burn out the starter motor.

Battery Charging

WARNING: Dangerous Acid, Explosive Gases!



Batteries contain sulfuric acid. To prevent acid burns, avoid contact with skin, eyes, and clothing. Batteries produce explosive hydrogen gas while being charged. To prevent a fire or explosion, charge batteries only in well ventilated areas. Keep sparks, open flames, and other sources of ignition away from the battery at all times. Keep batteries out of the reach of children. Remove all jewelry when servicing batteries.

Before disconnecting the negative (-) ground cable, make sure all switches are OFF. If ON, a spark will occur at the ground cable terminal which could cause an explosion if hydrogen gas or gasoline vapors are present.

Battery Maintenance

Regular maintenance will ensure the battery will accept and hold a charge.

1. Regularly check the level of electrolyte. Add distilled water as necessary to maintain the recommended level.

NOTE: Do not overfill the battery. Poor performance or early failure due to loss of electrolyte will result.

SECTION 8

ELECTRICAL SYSTEMS AND COMPONENTS

2. Keep the cables, terminals, and external surfaces of battery clean. A build-up of corrosive acid or grime on the external surfaces can self-discharge the battery. Self-discharging happens rapidly when moisture is present.
3. Wash the cables, terminals, and external surfaces with a baking soda and water solution. Rinse thoroughly with clear water.

NOTE: Do not allow the baking soda solution to enter the cells as this will destroy the electrolyte.

Battery Test

Test the battery voltage by connecting D.C. voltmeter across the battery terminals—crank the engine. If the battery drops below 9 volts while cranking, the battery is discharged or faulty. Refer to Figure 8-2.

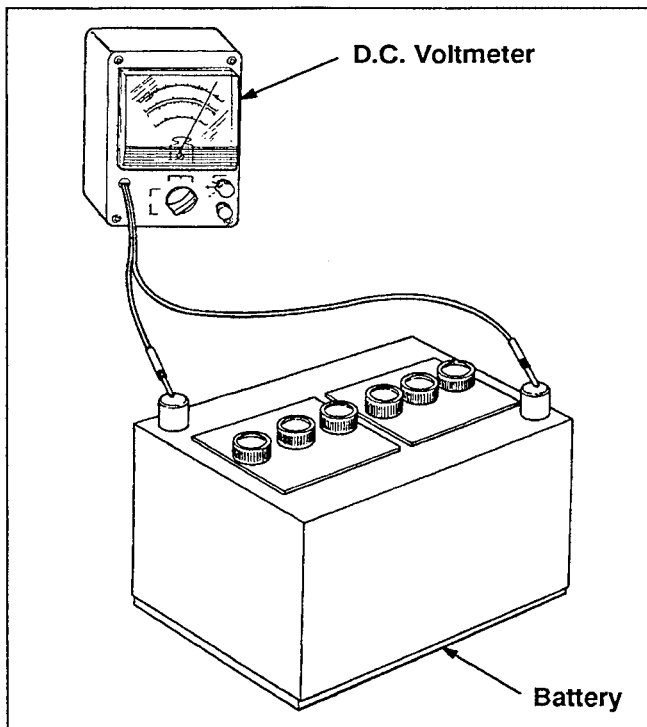

Figure 8-2. Checking Battery Voltage.

ELECTRONIC MAGNETO IGNITION SYSTEM

These engines are equipped with a dependable electronic magneto ignition system. The system consists of the following components:

- A magnet assembly which is permanently affixed to the flywheel.
- An electronic magneto ignition module which mounts on the engine crankcase.
- A kill switch (or keyswitch) which grounds the module to stop the engine.
- A spark plug.

Operation

As the flywheel rotates and the magnet assembly moves past the ignition module, a low voltage is induced in the primary windings of the module. When the primary voltage is precisely at its peak, the module induces a high voltage in its secondary windings. This high voltage creates a spark at the tip of the spark plug. This spark ignites the fuel-air mixture in the combustion chamber.

The timing of the spark is automatically controlled by the module. Therefore, other than periodically checking/replacing the spark plug, no maintenance, timing, or adjustments are necessary or possible with this system.

In the event starting problems should occur which are not corrected by replacing the spark plug, refer to the following "Troubleshooting Guide" for trouble analysis procedures.

SECTION 8 ELECTRICAL SYSTEMS AND COMPONENTS

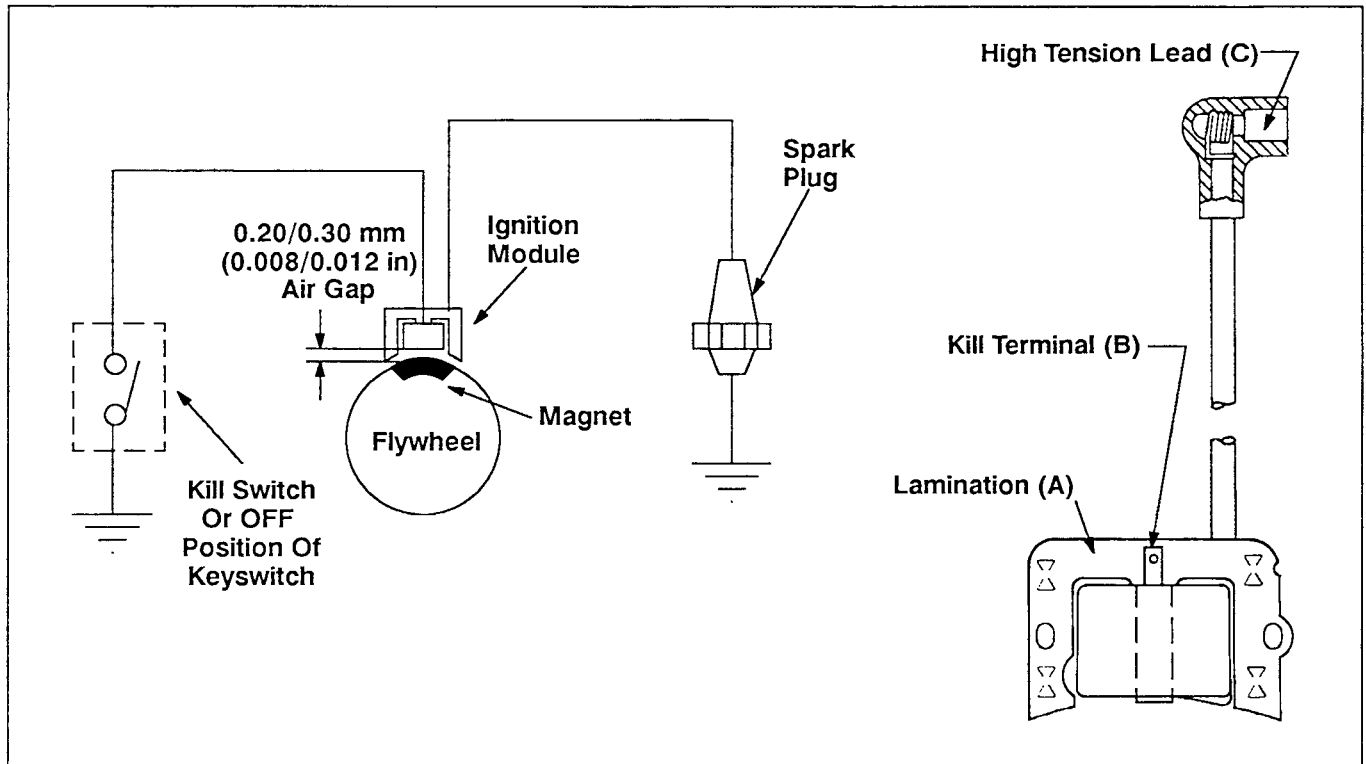

Figure 8-3. Electronic Magneto Ignition System.

Ignition System Troubleshooting Guide

The following guide will help locate and correct ignition system-related starting problems. This procedure uses a simple tester which can easily be made by the serviceman. Refer to Section 2—“Special Tools” for ignition system tester construction details.

NOTE: Use a low-voltage (2 volts or less) ohmmeter when ohmmeter is required. Always zero ohmmeter on each scale before testing to ensure accurate readings.

SECTION 8

ELECTRICAL SYSTEMS AND COMPONENTS

Problem	Test	Conclusion
ENGINE WILL NOT START	1. Make sure the spark plug lead is connected to the spark plug.	
	2. Check the condition of spark plug. Make sure gap is set to 1.02 mm (0.080 in)	2. If plug is in good condition, check/adjust gap and reinstall.
	3. Check ignition module using test plug. (Refer to Section 2 – “Special Tools.”) <ul style="list-style-type: none"> a. Remove the high-tension lead from the engine spark plug and connect them to the test plug. <p>NOTE: To maintain engine speeds normally obtained during cranking, do not remove the engine spark plug.</p> <ul style="list-style-type: none"> b. Make sure the engine ignition switch, kill switch, or keyswitch is in the “run” position. c. Crank the engine and observe the test plug. Visible and audible sparks should be produced. 	3. If visible and audible sparks are produced, the ignition module is OK. <p>If visible and audible sparks are not produced:</p> <ul style="list-style-type: none"> a. Make sure the engine ignition switch, kill switch, or keyswitch is in the “run” position. b. Check wires and terminals of ignition module and other components for accidental grounding and damaged insulation. c. If wires and terminals are OK, the ignition module is probably faulty and should be replaced. Test module further using an ohmmeter (Test 4).
	4b. Measure the resistance of module secondary using an ohmmeter (see Figures 8-3 and 8-4): <p>Connect one ohmmeter lead to laminations (A). Connect the other lead to the spark plug terminal of high-tension lead (C). With the ohmmeter leads connected in this manner, the resistance of secondary should be 7,900 to 10,850 ohms.</p> <p>NOTE: This test cannot be performed unless module has been fired at least once.</p>	If the resistance is low or 0 ohms , the module secondary is shorted. Replace the module. <p>If the resistance is high or infinity ohms, the module secondary is open. Replace the module.</p> <p>If the resistance is within the specified range, the module secondary is OK.</p>

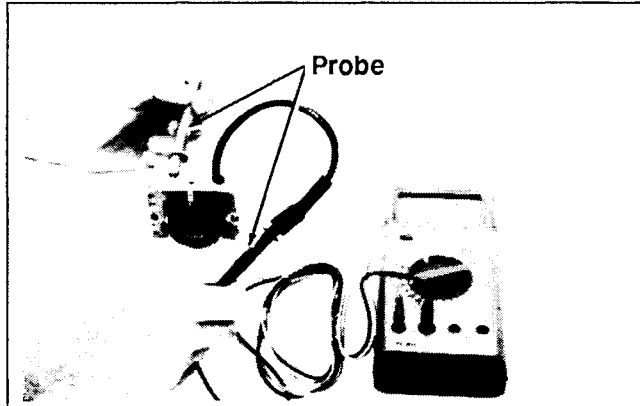

Figure 8-4. Testing Module Secondary.

Ignition Module Removal And Installation

Refer to the Disassembly and Reassembly sections for complete ignition module removal and installation procedures.

ELECTRICAL SYSTEMS WIRING DIAGRAMS AND BATTERY CHARGING SYSTEMS

This engine is equipped with a 15 Amp regulated battery charging system.

Refer to the following wiring diagram and troubleshooting guide to test and service this system.

NOTE: Observe the following guidelines to prevent damage to the electrical system and components.

1. Make sure the battery polarity is correct. A negative (-) ground system is used.
2. Disconnect the rectifier-regulator leads and/or wiring harness plug before doing electric welding on the equipment powered by the engine. Also disconnect other electrical accessories in common ground with the engine.
3. Prevent the stator (AC) leads from touching or shorting while the engine is running. This could damage the stator.

SECTION 8 ELECTRICAL SYSTEMS AND COMPONENTS

Electric Start Engines 15 Amp Battery Charging System

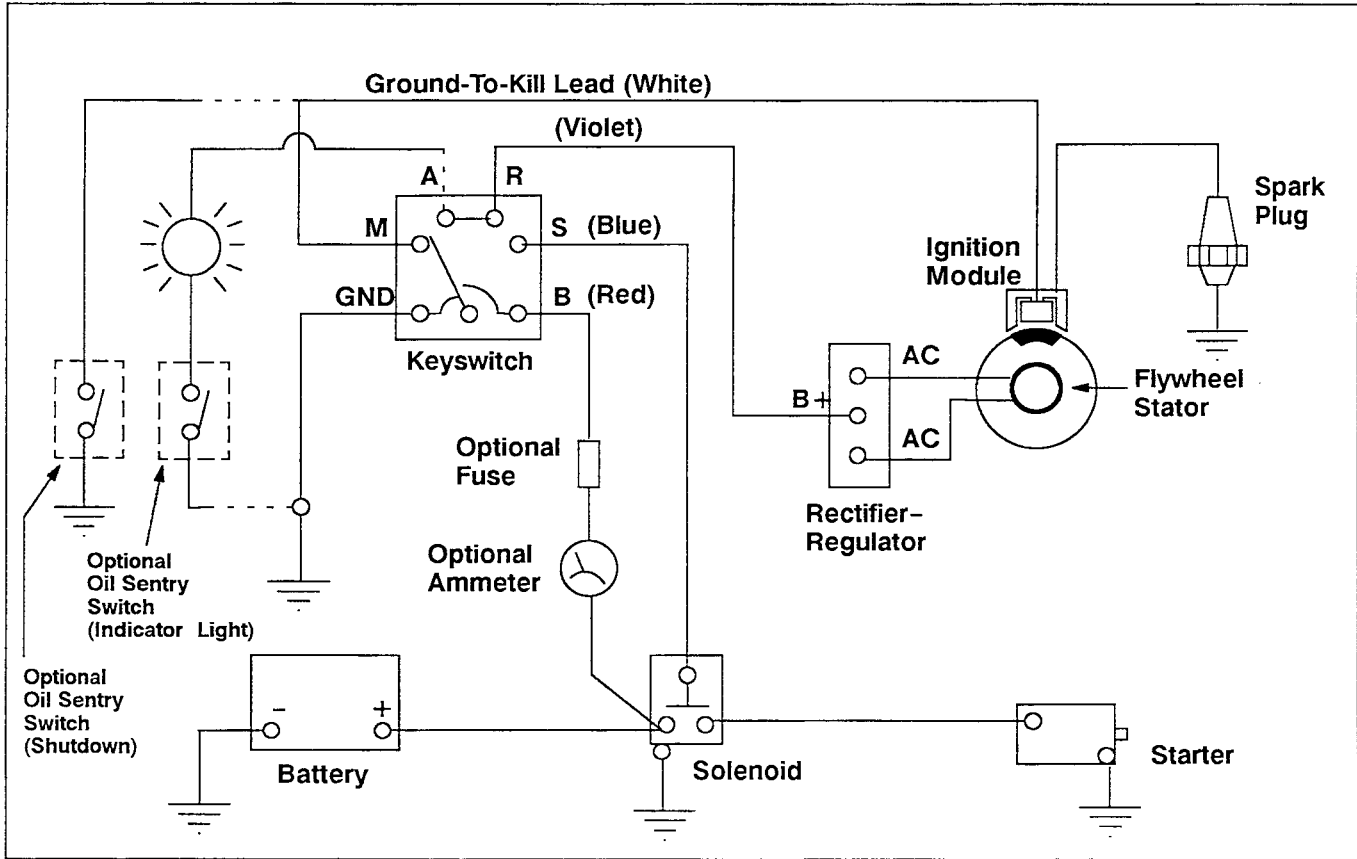

Figure 8-5. Wiring Diagram – Electric Start Engines/15 Amp Battery Charging System.

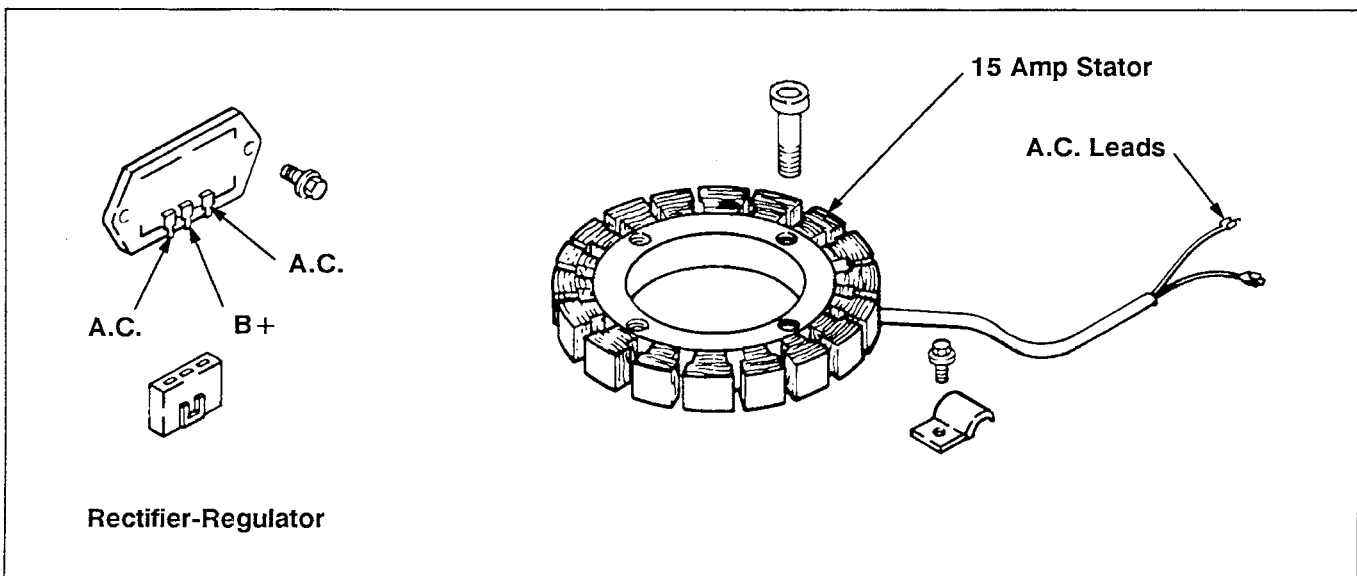

Figure 8-6. 15 Amp Stator And Rectifier-Regulator.

SECTION 8

ELECTRICAL SYSTEMS AND COMPONENTS

Troubleshooting Guide— 15 Amp Battery Charging System

NOTE: Zero ohmmeters and voltmeters on each scale to ensure accurate readings. Voltage tests should be made with the engine running at 3600 rpm—no load. The battery must be fully charged.

Problem	Test	Conclusion
No Charge To Battery	<p>1. Insert an ammeter in the B+ lead from rectifier-regulator. With engine running at 3600 rpm and B+ connected, measure the voltage from B+ (at terminal on rectifier-regulator) to ground using a DC voltmeter.</p> <p>If the voltage is 13.8 volts or more, place a minimum load of 5 amps* on the battery to reduce the voltage. Observe the ammeter.</p> <p>*NOTE: Turn on lights (if 60 watts or more) or place a 2.5 ohm, 100 watt resistor across the battery terminals.</p>	<p>1. If the charge rate increases when load is applied, the charging system is OK and the battery was fully charged.</p> <p>If the charge rate does not increase when load is applied, test the stator and rectifier-regulator (tests 2 and 3).</p>
	<p>2. Remove the connector from the rectifier-regulator. With the engine running at 3600 rpm, measure the AC voltage across stator leads using an AC voltmeter.</p>	<p>2. If the voltage is 28 volts or more, the stator is OK. The rectifier-regulator is faulty. Replace the rectifier-regulator.</p> <p>If the voltage is less than 28 volts, the stator is probably faulty. Test stator further using an ohmmeter (test 3).</p>
	<p>3a. With the engine stopped, measure the resistance across stator leads using an ohmmeter.</p>	<p>3a. If the resistance is 0.1/0.2 ohms, the stator is OK.</p> <p>If the resistance is infinity ohms, the stator is open. Replace the stator.</p>
	<p>3b. With the engine stopped, measure the resistance from each stator lead to ground using an ohmmeter.</p>	<p>3b. If the resistance is infinity ohms (no continuity), the stator is OK (not shorted to ground).</p> <p>If resistance (or continuity) is measured, the stator leads are shorted to ground. Replace the stator.</p>
Battery Continuously Charges At High Rate	<p>1. With the engine running at 3600 rpm, measure the voltage from B+ lead to ground using a DC voltmeter.</p>	<p>1. If the voltage is 14.7 volts or less, the charging system is OK; the battery is unable to hold a charge, or there is a bad connection between the rectifier-regulator and battery. Check the wiring harness; service or replace the battery as necessary.</p> <p>If the voltage is more than 14.7 volts, the rectifier-regulator is is faulty. Replace the rectifier-regulator.</p>

ELECTRIC STARTER

NOTE: Do not crank the engine continuously for more than 10 seconds at a time. If the engine does not start, allow a 60-second cool-down period

between starting attempts. Failure to follow these guidelines can burn out the starter motor.

SECTION 8 ELECTRICAL SYSTEMS AND COMPONENTS

NOTE: If the engine develops sufficient speed to disengage the starter but does not keep running (a false start), the engine rotation must be allowed to come to a complete stop before attempting to restart the engine. If the starter is engaged while the flywheel is rotating, the starter pinion and flywheel ring gear may clash, resulting in damage to the starter.

NOTE: If the starter does not crank the engine, shut

off the starter immediately. Do not make further attempts to start the engine until the condition is corrected. Do not attempt to jump start the engine with another battery. Starting with batteries larger than those recommended can burn out the starter motor.

NOTE: Do not drop the starter or strike the starter frame. Doing so can damage the ceramic permanent magnets inside the starter frame.

BENDIX DRIVE ELECTRIC STARTER

This subsection covers the operation, troubleshooting, and repair of the Bendix drive permanent magnet electric starter.

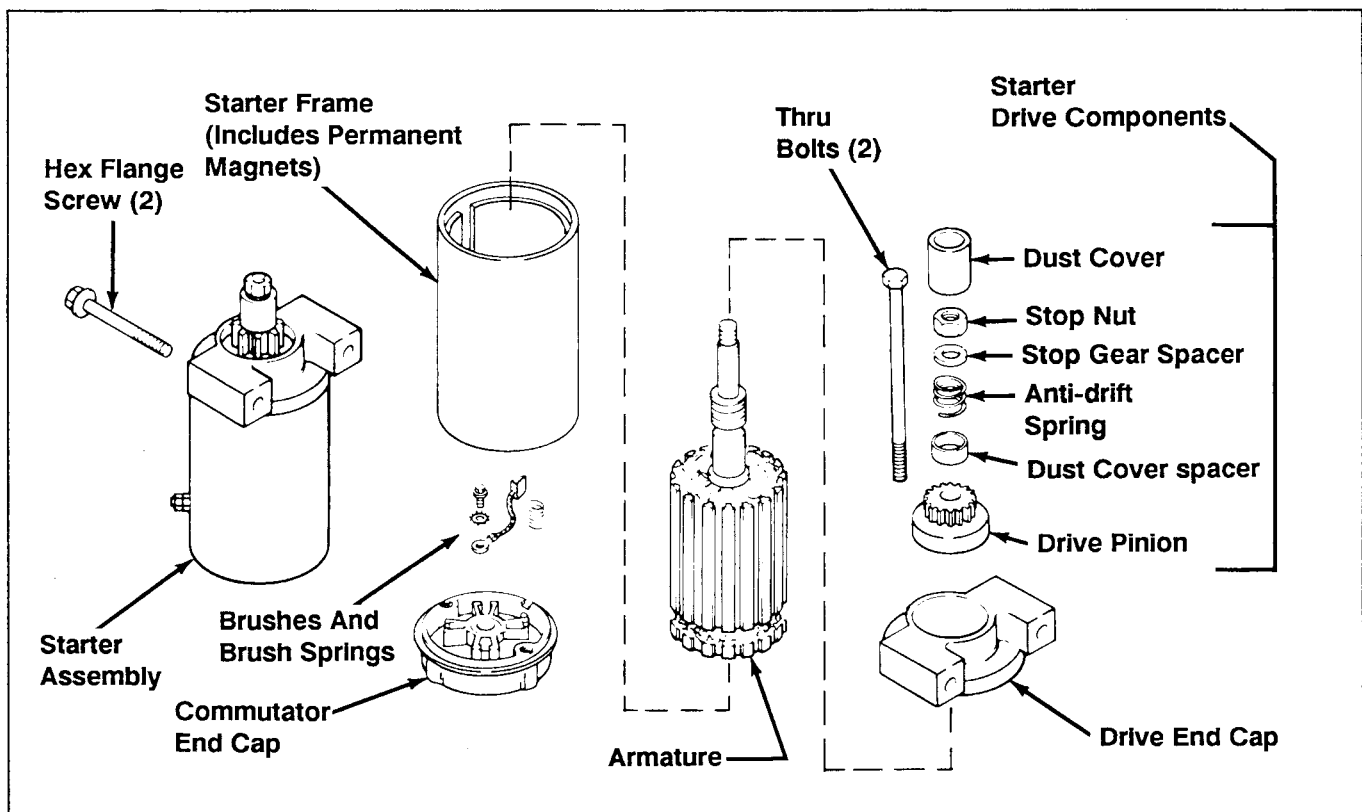

Figure 8-7. Bendix Drive Electric Starter.

Operation

When power is applied to the starter, the armature rotates. As the armature rotates, the drive pinion moves out on the splined drive shaft and into mesh with the flywheel ring gear. When the pinion reaches the end of

the drive shaft, it rotates the flywheel and "cranks" the engine.

SECTION 8

ELECTRICAL SYSTEMS AND COMPONENTS

When the engine starts, the flywheel rotates faster than the starter armature and drive pinion. This moves the drive pinion out of mesh with the ring gear and into the retracted position. When power is removed from

the starter, the armature stops rotating and the drive pinion is held in the retracted position by the anti-drift spring.

Troubleshooting Guide

Problem	Possible Fault	Correction
Starter Does Not Energize	Battery	1. Check the specific gravity of battery. If low, recharge or replace battery as necessary.
	Wiring	1. Clean corroded connections and tighten loose connections. 2. Replace wires in poor condition and with frayed or broken insulation.
	Starter Switch Or Solenoid	1. Bypass the switch or solenoid with a jumper cable. If starter cranks normally, replace the faulty components.
Starter Energizes But Turns Slowly	Battery	1. Check the specific gravity of battery. If low, recharge or replace battery as necessary.
	Brushes	1. Check for excessively dirty or worn brushes and commutator. Clean using a coarse cloth (not emery cloth). 2. Replace brushes if excessively or unevenly worn.
	Transmission Or Engine	1. Make sure the clutch or transmission is disengaged or placed in neutral. This is especially important on equipment with hydrostatic drive. The transmission must be exactly in neutral to prevent resistance which could keep the engine from starting. 2. Check for seized engine components such as the bearings, connecting rod, and piston.

Starter Removal And Installation

Refer to the "Disassembly" and "Reassembly" sections for starter removal and installation procedures.

Starter Drive Service (Refer To Figure 8-7.)

Every **500 hours** of operation (or annually, whichever occurs first), clean and lubricate the splines on the starter drive shaft. If the drive pinion is worn, or has chipped or broken teeth, it must be replaced.

It is not necessary to completely disassemble the starter to service the drive components. Service the drive as follows:

1. Remove the starter from the engine.
2. Remove the dust cover.

3. Hold the drive pinion in a vice with soft jaws when removing and installing the stop nut. The armature will rotate with the nut until the drive pinion stops against internal spacers.

NOTE: Do not overtighten the vise as this can distort the drive pinion.

4. Remove the stop nut, stop gear spacer, anti-drift spring, dust cover spacer, and drive pinion.
5. Clean the splines on drive shaft thoroughly with solvent. Dry the splines thoroughly.
6. Apply a small amount of Kohler electric starter drive lubricant to the splines.

NOTE: Kohler electric starter drive lubricant must be used on all Kohler electric starter drives. The use of other lubricants can cause the drive pinion to stick or bind.

SECTION 8 ELECTRICAL SYSTEMS AND COMPONENTS

7. Apply a small amount of **Loctite® no. 271** to the stop nut threads.
8. Install the drive pinion, dust cover spacer, anti-drift spring, stop gear spacer, and stop nut. Torque the stop nut to **17.0/19.2 N·m (135 lbf·in)**.
9. Install the dust cover.

Starter Disassembly

1. Remove the dust cover, stop nut, stop gear spacer, anti-drift spring, dust cover spacer, and drive pinion. Refer to "Starter Drive Service" above.
2. Scribe a small line on the drive end cap, opposite the line on the starter frame. These lines will serve as match marks when reassembling the starter. See Figure 8-10.
3. Remove the thru bolts.
4. Remove the commutator end cap with brushes and brush springs.
5. Remove the drive end cap.
6. Remove the armature and thrust washer from inside the starter frame.

Brush Replacement

1. Remove the brush springs from the pockets in brush holder. See Figure 8-8.
2. Remove the self-tapping screws, negative (-) brushes, and plastic brush holder.
3. Remove the hex flange nut and fiber washer from the stud terminal.

Remove the stud terminal with positive (+) brushes and plastic insulating bushing from the end cap.

4. Reinstall the insulating bushing to the new stud terminal with positive (+) brushes. Install the stud terminal with bushing into the commutator end cap. Secure the stud with the fiber washer and hex flange screw.
5. Install the brush holder, new negative (-) brushes, and self-tapping screws.
6. Install the brush springs and brushes into the pockets in brush holder. Make sure the chamfered sides of brushes are away from the brush springs.

NOTE: Use a brush holder tool to keep the brushes in the pockets. A brush holder tool can easily be made from thin sheet metal. See Figure 8-9.

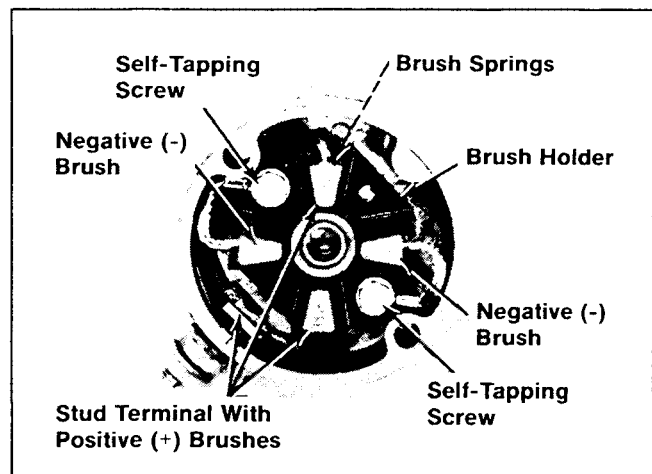

Figure 8-8. Commutator End Cap With Brushes.

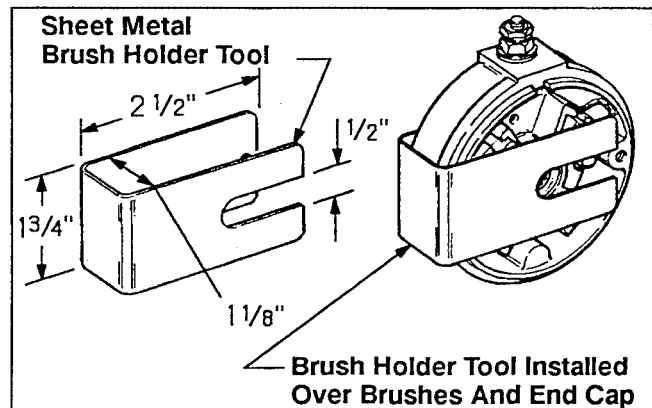

Figure 8-9. Brush Holder Tool.

SECTION 8

ELECTRICAL SYSTEMS AND COMPONENTS

Commutator Service

Clean the commutator with a coarse, lint free cloth. Do not use emery cloth.

If the commutator is badly worn or grooved, turn it down on a lathe or replace the armature.

Starter Reassembly

1. Place the thrust washer over the drive shaft of armature.
2. Insert the armature into the starter frame. Make sure the magnets are closer to the drive shaft end of armature. The magnets will hold the armature inside the frame.
3. Install the drive end cap over the drive shaft. Make sure the match marks on the end cap and starter frame are aligned. See Figure 8-10.
4. Install the brush holder tool to keep the brushes in the pockets of the commutator end cap.
5. Align the match marks on the commutator end cap and starter frame. Hold the drive end and commutator end caps firmly to the starter frame. Remove the brush holder tool.
6. Install the thru bolts and tighten securely.
7. Lubricate the drive shaft with Kohler electric starter drive lubricant. Install the drive pinion, dust cover spacer, anti-drift spring, stop gear spacer, stop nut, and dust cover. Refer to "Starter Drive Service" above.

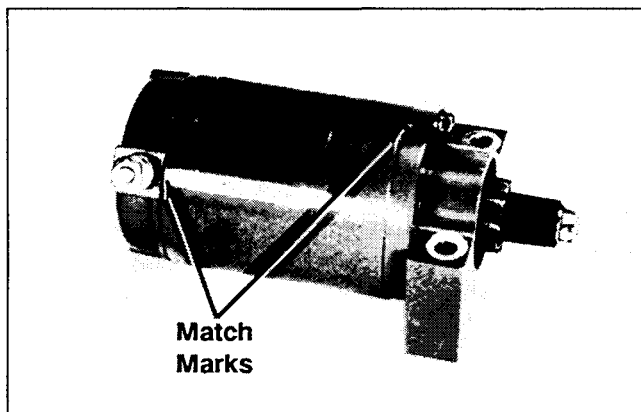

Figure 8-10. Starter Assembly Match Marks.

SOLENOID SHIFT ELECTRIC STARTER

This sub-section covers the solenoid shift electric starter. Much of the information in the preceding sub-section relates to this starter, therefore it is not repeated here. Please use the exploded view on the following page for the disassembly and assembly procedure.

SECTION 8 ELECTRICAL SYSTEMS AND COMPONENTS

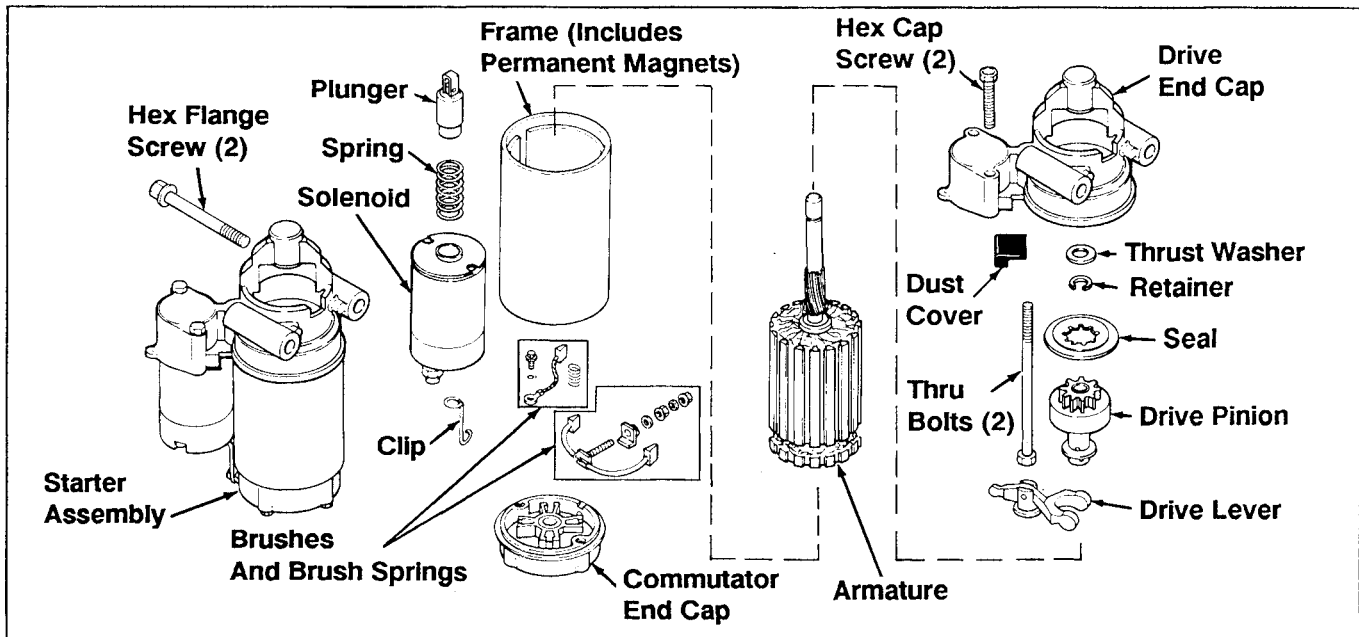

Figure 8-11. Solenoid Shift Electric Starter

Operation

When power is applied to the starter the electric solenoid moves the drive pinion out onto the drive shaft and into mesh with the flywheel ring gear. When the pinion reaches the end of the drive shaft it rotates the flywheel and cranks the engine.

When the engine starts and the start switch is released the starter solenoid is deactivated, the drive lever moves back, and the drive pinion moves out of mesh with the ring gear into the retracted position.

Starter Removal and Installation

Refer to the disassembly and reassembly sections for starter removal and installation procedures.

Starter Disassembly

1. Remove clip.
2. Remove cap screws and solenoid. Scribe alignment marks on caps and frame to aid assembly.
3. Remove thru bolts, drive end cap, commutator end cap, and frame.

4. Remove drive lever.
5. Remove thrust washer and retainer to remove drive pinion from shaft.

Brush Replacement

Replacing brushes in the solenoid shift starts is exactly the same procedure as explained in the previous sub-section. Refer to page 8.12, figure 8-8, figure 8-9.

Commutator Service

Same as previous sub-section.

Starter Service

Clean drive lever and armature shaft. Apply Kohler electric starter drive lubricant or equivalent to lever and shaft.

Starter Reassembly

1. Slide frame over armature and place commutator end cap in position. Hold in position temporarily with tape.

SECTION 8

ELECTRICAL SYSTEMS AND COMPONENTS

NOTE: Be sure alignment marks on caps and frame are in proper position.

2. Place drive pinion (with seal), thrust washer and retainer on drive shaft.
3. Place lever in position on drive shaft.
4. Place solenoid plunger on drive lever and position drive end cap over drive shaft. (Be sure the rubber dust cover is in place at the drive lever.)
5. Fasten the end caps with the thru bolts.
6. Place the spring in the solenoid and fasten solenoid to drive end cap using hex cap screws.
7. Replace the clip.

SECTION 9 DISASSEMBLY

WARNING: Accidental Starts!



Before servicing the engine or equipment, always disconnect the spark plug lead to prevent the engine from starting accidentally. Ground the lead to prevent sparks which could cause fires.

The following sequence is suggested for complete engine disassembly. This procedure can be varied to accommodate options or special equipment.

Clean all parts thoroughly as the engine is disassembled. Only clean parts can be accurately inspected and gauged for wear or damage. There are many commercially available cleaners that will quickly remove grease, oil, and grime from engine parts. When such a cleaner is used, follow the manufacturer's instructions and safety precautions carefully.

Make sure all traces of the cleaner are removed before the engine is reassembled and placed into operation. Even small amounts of these cleaners can quickly break down the lubricating properties of engine oil.

TYPICAL DISASSEMBLY SEQUENCE

1. Remove spark plug.
2. Drain oil.
3. Remove muffler and bracket.
4. Remove air cleaner cover.
5. Remove air cleaner element, base, and breather hose.
6. Remove choke control.
7. Remove fuel tank and bracket.
8. Remove retractable starter.
9. Remove fuel pump.
10. Remove starter cover — electrical starter.
11. Remove rectifier-regulator.
12. Remove Oil Sentry.
13. Remove throttle control bracket.

14. Remove carburetor.
15. Remove valve cover.
16. Remove cylinder head baffle.
17. Remove blower housing and baffles.
18. Remove ignition module.
19. Remove fuel line.
20. Remove cylinder head push rods/gasket.
21. Remove drive cup, grass screen, flywheel and fan.
22. Remove stator and wiring harness.
23. Remove oil fill tube — if necessary.
24. Remove closure plate.
25. Remove camshaft and hydraulic lifters.
26. Remove balance shaft.
27. Remove connecting rod.
28. Remove piston.
29. Remove crankshaft.
30. Remove main bearing.
31. Remove governor gear.
32. Remove governor cross shaft seal.

DISCONNECT SPARK PLUG LEAD

NOTE: Pull on boot only, to prevent damage to spark plug lead.

DRAIN OIL FROM CRANKCASE AND REMOVE OIL FILTER

1. Remove the oil drain plug and oil fill cap/dipstick. See Figure 9-1.
2. Allow ample time for the oil to drain from the crankcase and oil filter.
3. Remove and discard the oil filter.

SECTION 9 DISASSEMBLY

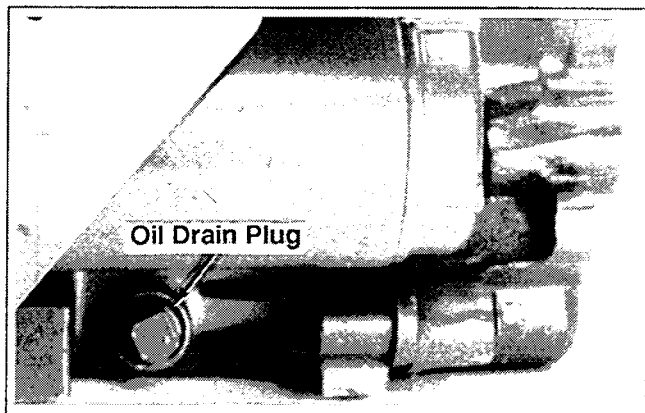

Figure 9-1. Removing Oil Drain Plug.

REMOVE MUFFLER

1. Remove the hex flange nuts from exhaust studs and hex flange screws from muffler bracket. See Figures 9-2 and 9-3.
2. Remove the muffler and gasket from exhaust outlet flange.

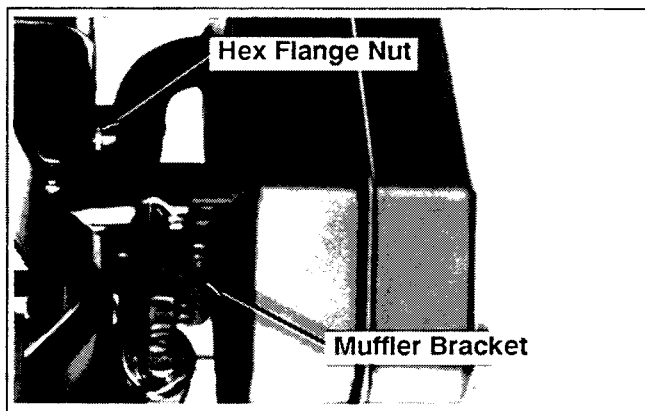

Figure 9-2. Removing Muffler.

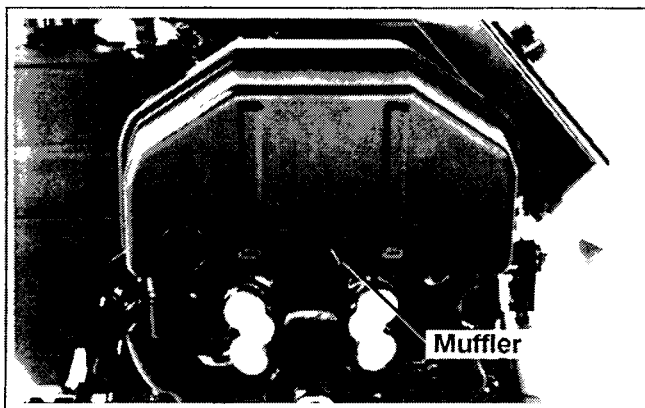

Figure 9-3. Removing Muffler.

REMOVE AIR CLEANER

1. Remove the knob and air cleaner cover. See Figure 9-4.

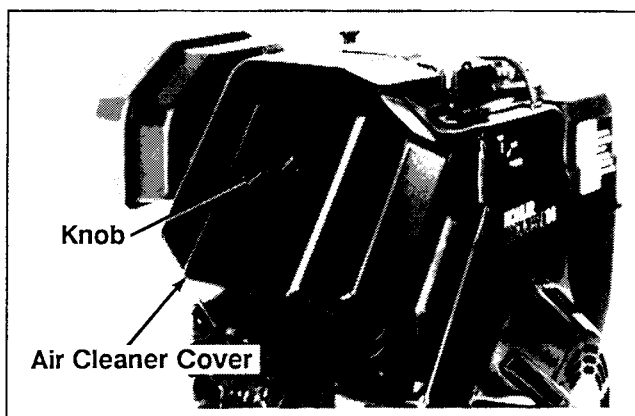

Figure 9-4. Removing Air Cleaner Cover.

2. Remove the wing nut, washer, element cover, element and precleaner. See figure 9-5.

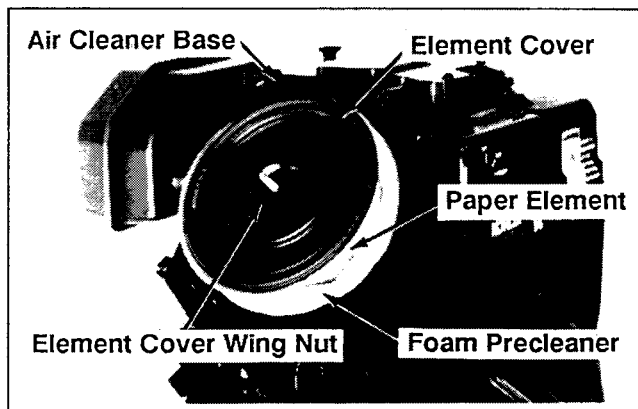

Figure 9-5. Removing Air Cleaner Elements.

3. Remove the hex flange nuts from the intake studs, and the air cleaner base and gasket from the studs. See Figure 9-6.
4. Loosen the hose clamp and disconnect the breather hose from the rocker arm cover. Remove the air cleaner base from the studs and disconnect choke linkage from the carburetor choke lever. See Figure 9-7.

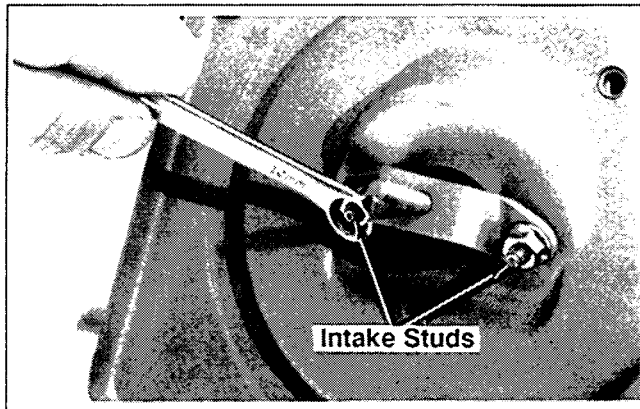

Figure 9-6. Removing Air Cleaner Base.

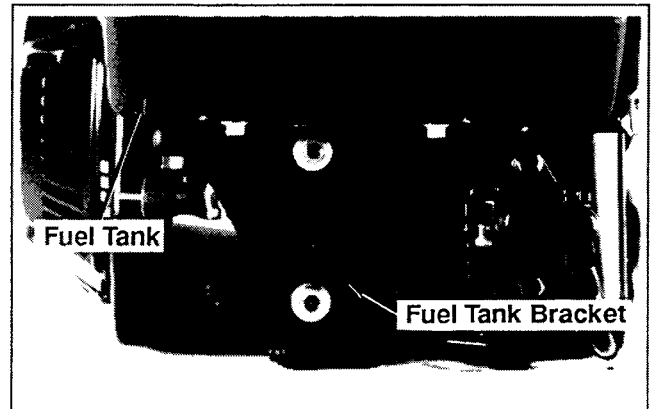

Figure 9-8. Removing Fuel Tank.

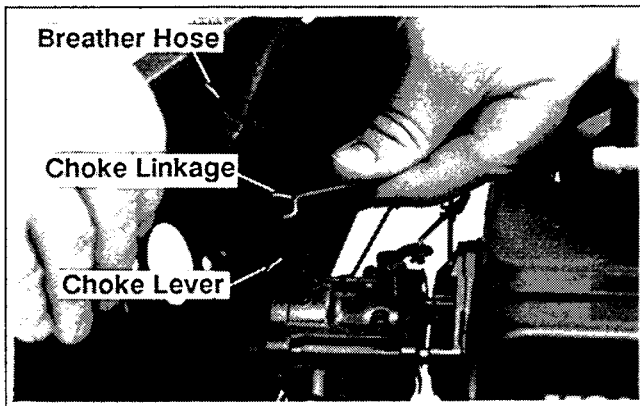

Figure 9-7. Removing Air Cleaner Base.

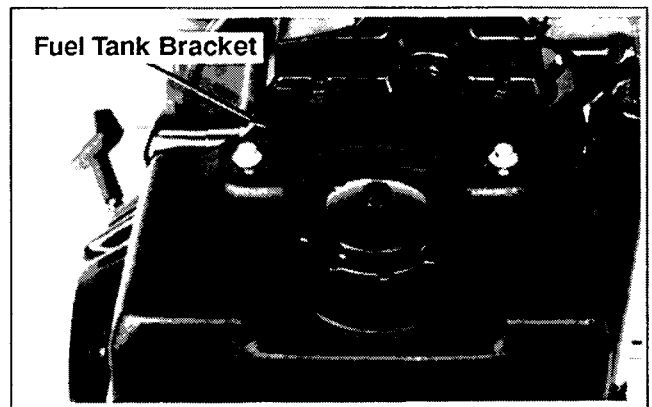

Figure 9-9. Removing Fuel Tank.

REMOVE FUEL TANK



Explosive Fuel!

Gasoline may be present in the carburetor and fuel system. Gasoline is extremely flammable, and its vapors can explode if ignited. Keep sparks, open flames, and other sources of ignition away from the engine.

1. Turn fuel shut-off valve to OFF (horizontal) position.
2. Remove hex flange nuts from lower bracket and hex flange screws from upper bracket of fuel tank. See Figures 9-8 and 9-9.
3. Remove the fuel tank and disconnect fuel hose from shut-off valve.

REMOVE RETRACTABLE STARTER

1. Remove the five hex flange screws and retractable starter. See Figure 9-10.

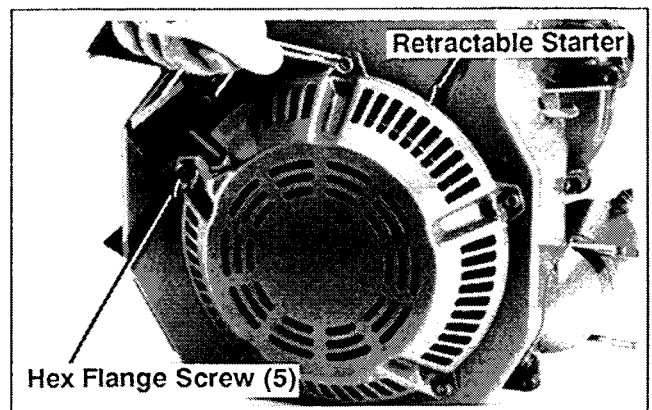

Figure 9-10. Removing Retractable Starter.

SECTION 9 DISASSEMBLY

REMOVE FUEL PUMP



Explosive Fuel!

Gasoline may be present in the carburetor and fuel system. Gasoline is extremely flammable, and its vapors can explode if ignited. Keep sparks, open flames, and other sources of ignition away from the engine.

1. Disconnect the fuel line from the outlet and inlet fittings of the fuel pump. See Figure 9-11.
2. Remove the two hex flange screws, fuel pump, and gasket.

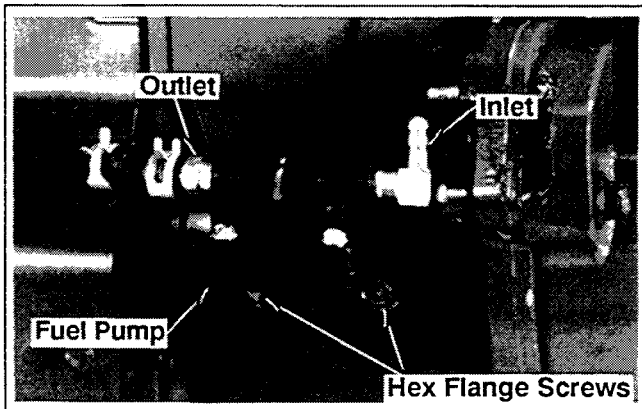

Figure 9-11. Removing Fuel Pump.

REMOVE ELECTRIC STARTER

Electric Starter (Bendix Drive or Solenoid Shift)

1. Disconnect the lead from the stud terminal. See Figure 9-12. Disconnect both leads on Solenoid Shift Starter.
2. Remove the two hex flange screws and starter cover.
3. Remove the starter assembly and spacers from the studs.

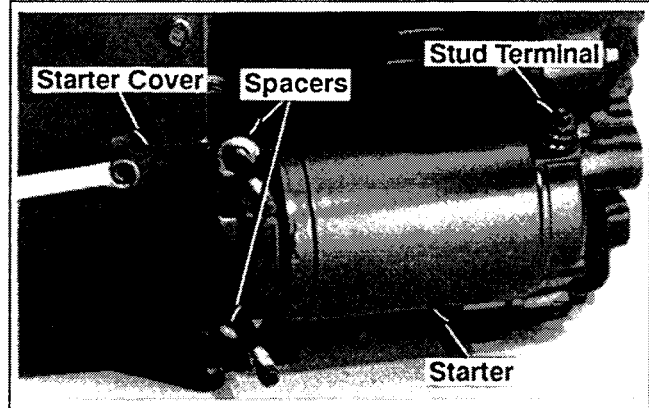

Figure 9-12. Removing Bendix Drive Starter.

REMOVE RECTIFIER-REGULATOR

1. Remove the wire connector from the rectifier-regulator. See Figure 9-13.
2. Remove the two hex flange screws and rectifier-regulator.

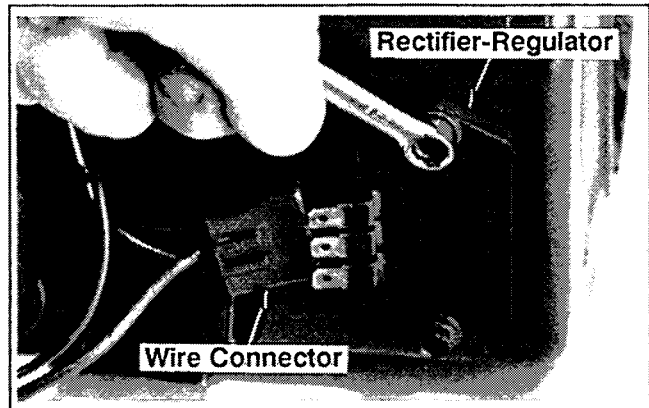

Figure 9-13. Removing Rectifier-Regulator.

REMOVE OIL SENTRY™

1. Disconnect the lead from the Oil Sentry™ switch.
2. Remove Oil Sentry™ switch from the oil filter adapter. See Figure 9-14.

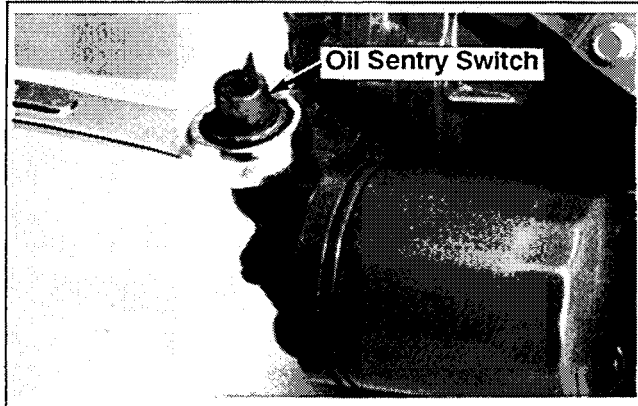

Figure 9-14. Removing Oil Sentry.

REMOVE THROTTLE CONTROL BRACKET

1. Remove two hex flange screws from throttle control bracket. See Figure 9-15.
2. Remove governor lever spring from throttle control bracket. See Figure 9-16.

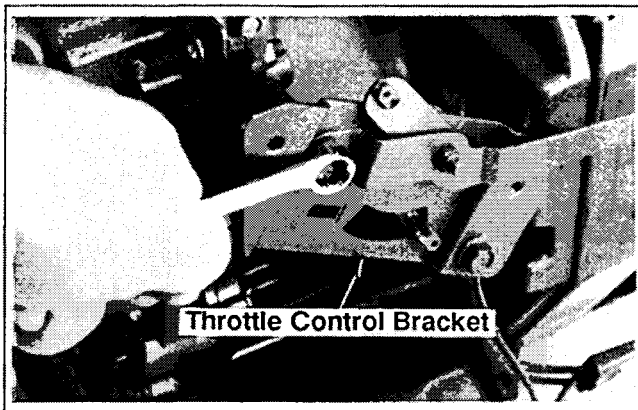

Figure 9-15. Removing Throttle Control Bracket.

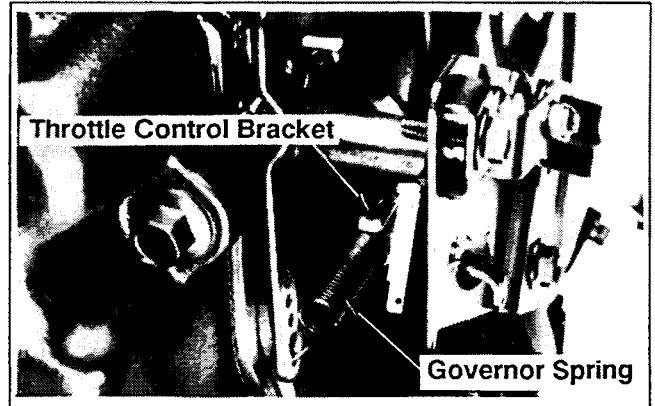

Figure 9-16. Removing Governor Spring.

REMOVE CARBURETOR



Explosive Fuel!

Gasoline may be present in the carburetor and fuel system. Gasoline is extremely flammable, and its vapors can explode if ignited. Keep sparks, open flames, and other sources of ignition away from the engine.

1. Remove fuel line from carburetor inlet fitting. See Figure 9-17.
2. Disconnect the throttle linkage from the bushing in carburetor governor lever.
3. Remove carburetor and gasket from intake studs.

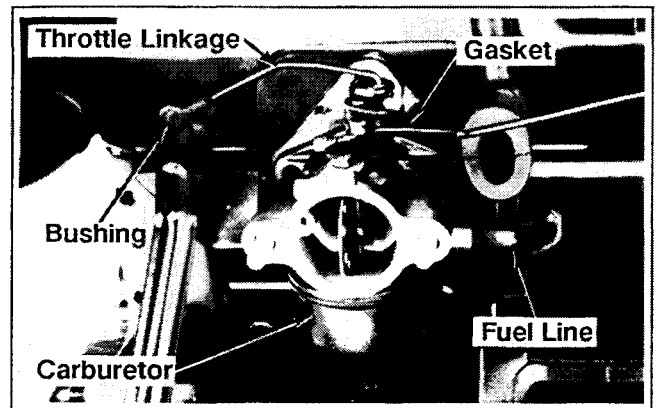

Figure 9-17. Removing Carburetor.

SECTION 9 DISASSEMBLY

REMOVE VALVE COVER

1. Remove the five hex flange valve cover screws and valve cover from the cylinder head assembly. See Figure 9-18.

NOTE: The valve cover is sealed to the cylinder head using RTV silicone sealant. When removing valve cover, use care not to damage the gasket surfaces of cover and cylinder head.

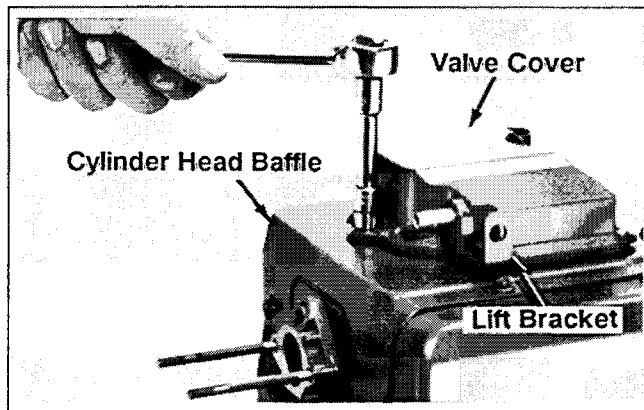

Figure 9-18. Removing Valve Cover.

REMOVE CYLINDER HEAD BAFFLE

1. Remove the hex flange screws securing the cylinder head baffle to the cylinder head. See Figure 9-19. Remove the baffle.

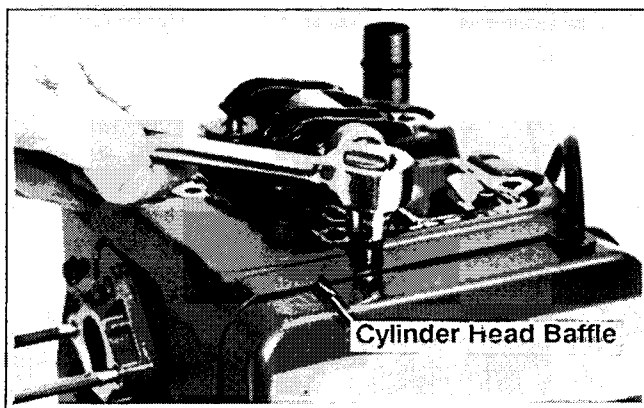

Figure 9-19. Removing Cylinder Head Baffle.

REMOVE BLOWER HOUSING AND BAFFLES

1. Remove the hex flange screws from blower housing and baffles. Disconnect wire harness from the key switch, if equipped. Remove the blower housing and baffles.

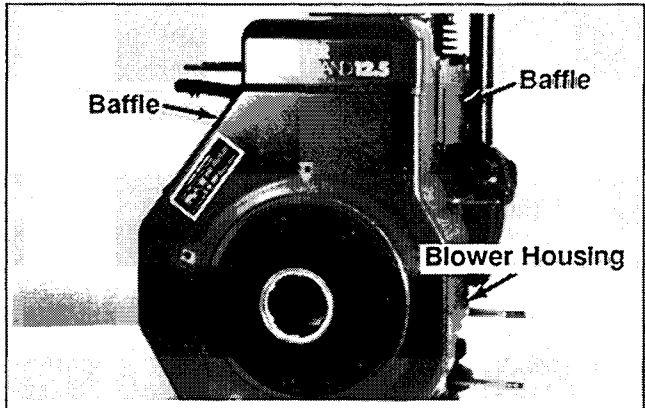

Figure 9-20. Removing Blower Housing and Baffles.

REMOVE IGNITION MODULE

1. Disconnect the kill lead from the ignition module terminal. See Figure 9-21.
2. Rotate flywheel magnet away from ignition module.
3. Remove the two hex flange screws and ignition module.

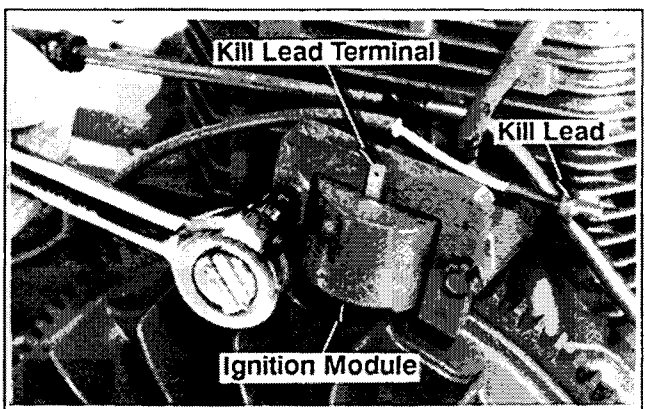

Figure 9-21. Removing Ignition Module.

REMOVE FUEL LINE

1. Remove the hex flange screw, clip, and fuel line. See Figure 9-22.

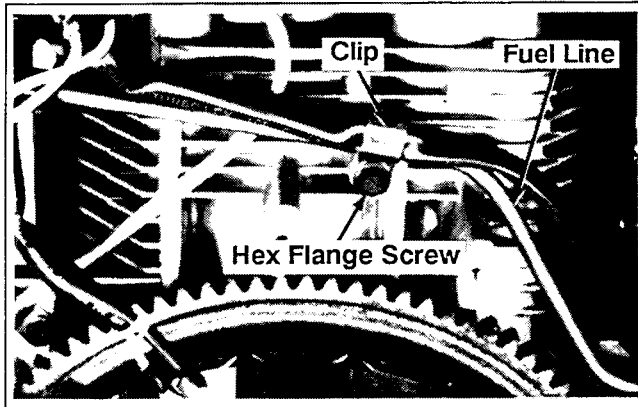

Figure 9-22. Removing Fuel Line.

REMOVE CYLINDER HEAD

1. Remove the hex flange screws, spacer (from the screw by the exhaust port), cylinder head, push rods, and cylinder head gasket. See Figures 9-23 and 9-24.

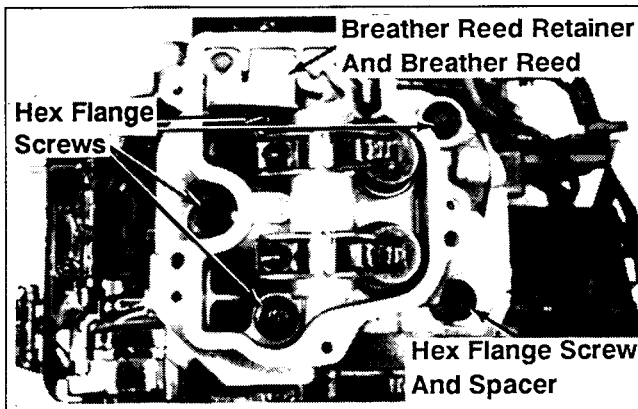

Figure 9-23. Removing Cylinder Head.

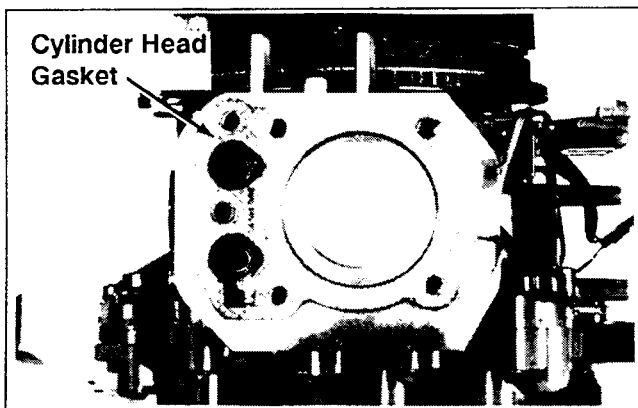

Figure 9-24. Removing Cylinder Head Gasket.

DISASSEMBLE CYLINDER HEAD

1. Remove the spark plug. See Figure 9-25.

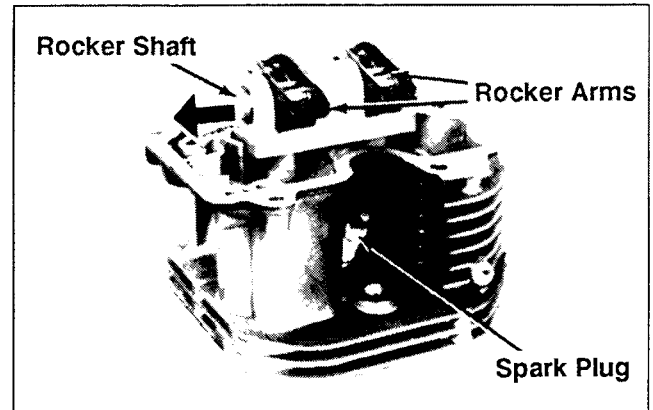

Figure 9-25. Removing Spark Plug And Rocker Arms.

2. Remove the hex flange screw, breather reed retainer, and breather reed.
3. Remove the rocker shaft (from the breather side of head), and rocker arms.
4. Remove the valves:
 - a. Compress the valve springs using a valve spring compressor. See Figure 9-26.
 - b. Remove the keepers, valve spring caps, valve springs, exhaust valve rotator, intake valve spring seat, and intake valve stem seal. See Figures 9-27 and 9-28.
5. Remove the two hex cap screws and rocker bridge.

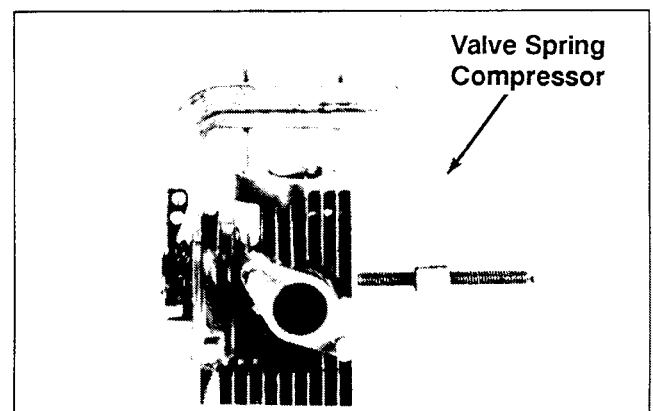

Figure 9-26. Removing Valves With Valve Spring Compressor.

SECTION 9 DISASSEMBLY

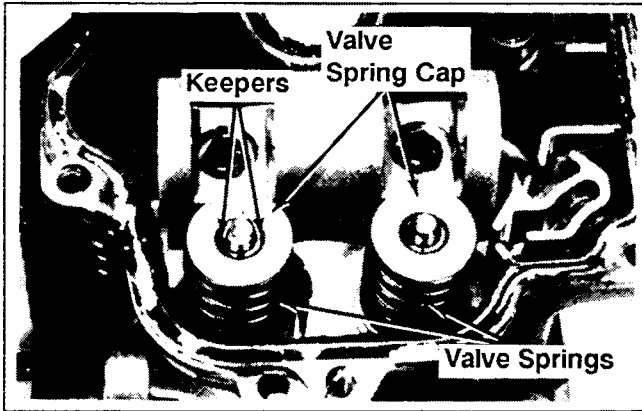

Figure 9-27. Removing Valves.

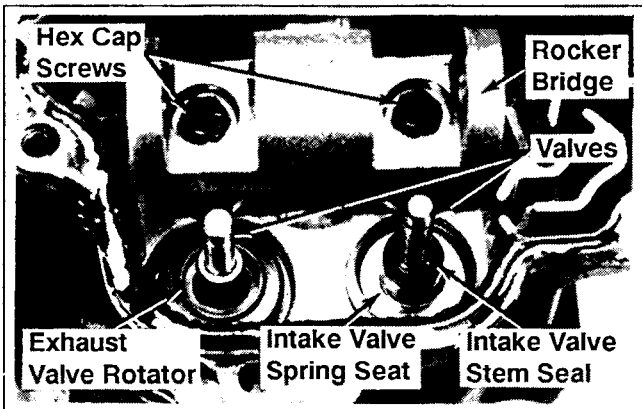

Figure 9-28. Removing Valves.

REMOVE DRIVE CUP, GRASS SCREEN, FLYWHEEL, AND FAN

NOTE: Always use the flywheel strap wrench to hold the flywheel when loosening or tightening the flywheel and fan retaining fasteners. Do not use any type of bar or wedge between the fins of cooling fan as the fins could become cracked or damaged.

NOTE: Always use a puller to remove the flywheel from the crankshaft. Do not strike the crankshaft or flywheel, as these parts could become cracked or damaged.

1. Remove the hex flange screw, plain washer, and drive cup. See Figure 9-29.

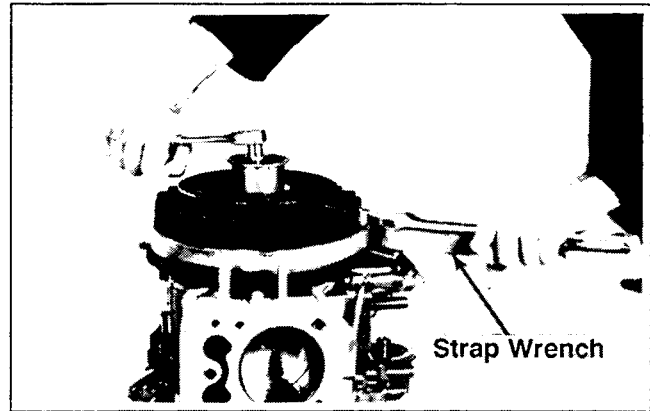

Figure 9-29. Removing Flywheel Retaining Screw And Drive Cup.

2. Unsnap and remove the grass screen from fan.
3. Remove the flywheel from the crankshaft using a puller. See Figure 9-30.

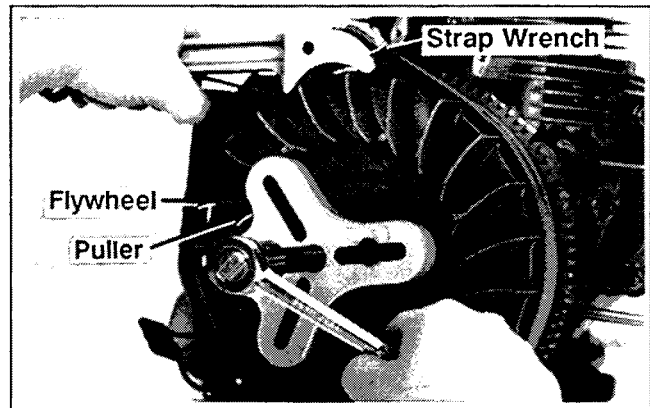

Figure 9-30. Removing Flywheel With A Puller.

4. Remove the four hex flange screws and fan from flywheel. See Figure 9-31.

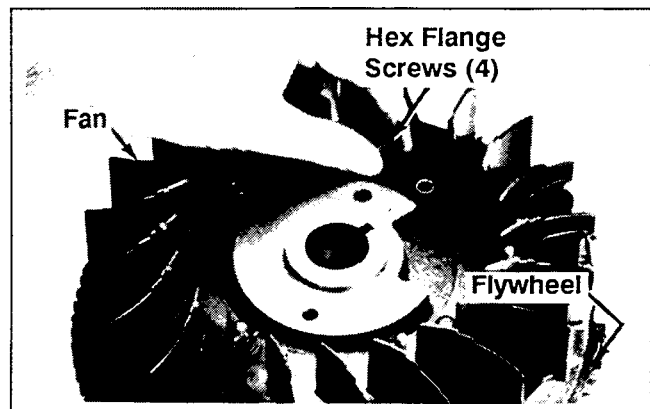

Figure 9-31. Removing Fan From Flywheel.

REMOVE THE STATOR AND WIRING HARNESS

1. Remove the stator leads from connector body.
2. Remove the hex flange screw and clip securing the stator leads to the crankcase. See Figure 9-32.
3. Remove the hex flange screw and clip securing the kill lead to the crankcase. Remove the four hex socket head screws and stator.

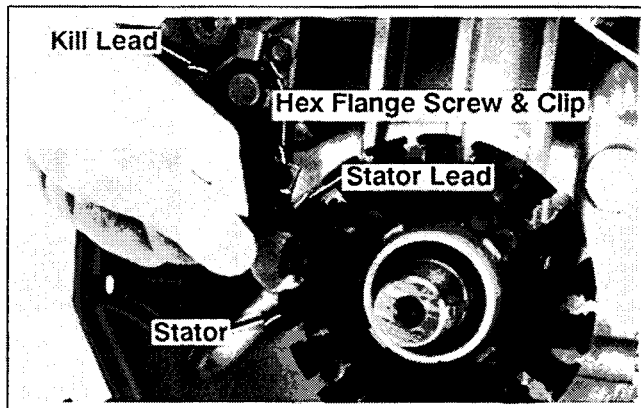

Figure 9-32. Removing Stator.

REMOVE CLOSURE PLATE

1. Remove the twelve hex flange screws securing the closure plate to the crankcase. See Figure 9-33.

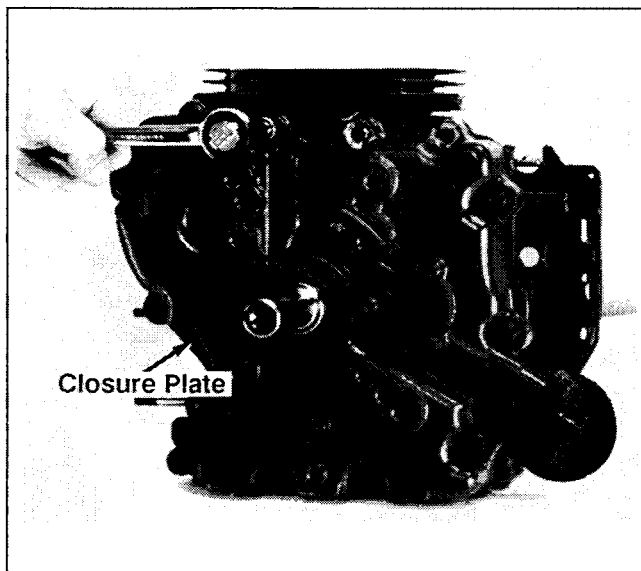

Figure 9-33. Removing Closure Plate.

2. Locate the splitting notches in the seam of the closure plate and crankcase. See Figure 9-34. Pry the closure plate from the crankcase using a large flat-blade screwdriver.

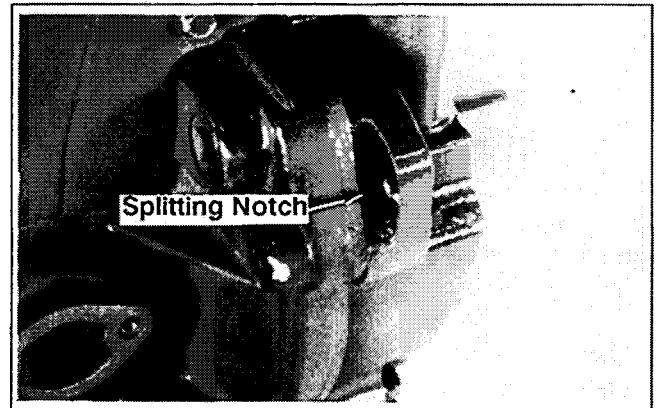

Figure 9-34. Splitting Notch of Closure Plate/Crankcase.

NOTE: Insert the screwdriver only in the splitting notches. Do not pry on the gasket surfaces of the closure plate or crankcase as this can cause leaks.

REMOVE OIL PICKUP, OIL PRESSURE RELIEF VALVE, OIL PUMP, AND OIL SEAL

1. Remove the oil seal from the closure plate. See Figure 9-35.
2. Remove the hex flange screw, clip, oil pickup, and O-ring seal.

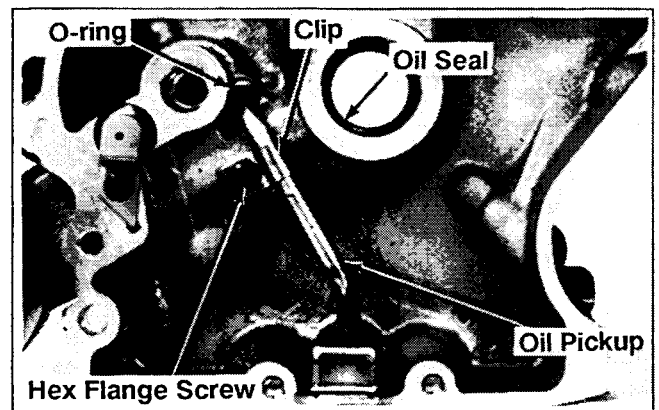

Figure 9-35. Removing Oil Seal And Pickup.

3. Remove the hex socket screw, oil pressure relief bracket, relief valve body, piston, and spring. See Figures 9-35 and 9-36.

SECTION 9 DISASSEMBLY

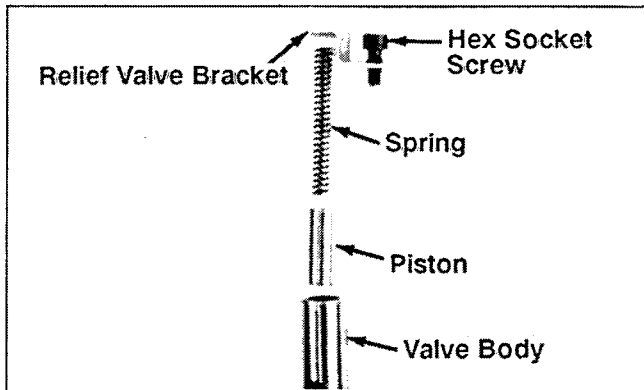

Figure 9-36. Removing Oil Pressure Relief Valve Body, Piston, And Spring.

- Remove the three hex flange screws, oil pump cover, O-ring, and oil pump rotors. See Figure 9-37.

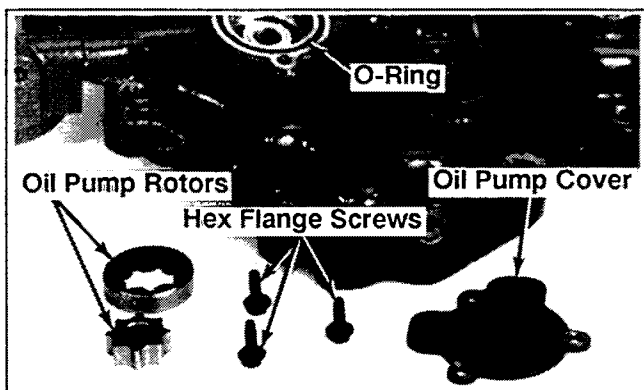

Figure 9-37. Removing Oil Pump.

REMOVE CAMSHAFT AND HYDRAULIC LIFTERS

- Remove the camshaft and shim. See Figure 9-38.

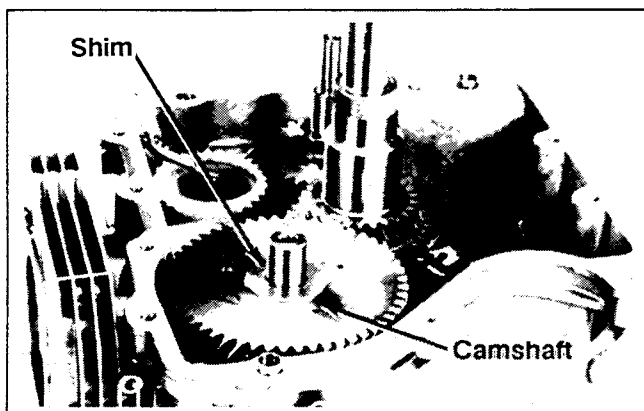

Figure 9-38. Removing Camshaft.

- Mark or identify the hydraulic lifters as either intake or exhaust. See Figure 9-39. Remove the lifters from the crankcase.

NOTE: The intake hydraulic lifter is farthest from the crankcase gasket surface. The exhaust hydraulic lifter is nearest to the crankcase gasket surface.

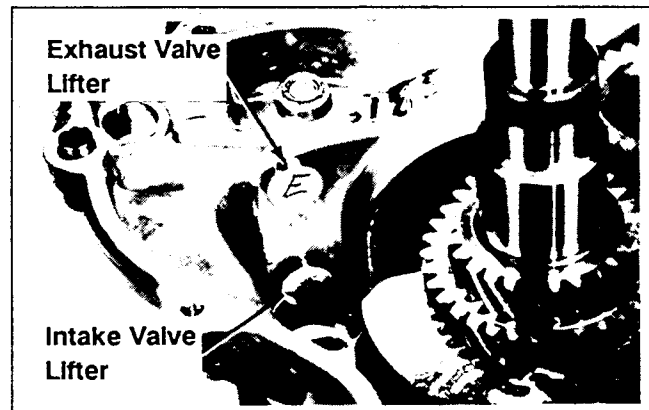

Figure 9-39. Identifying Hydraulic Lifters.

REMOVE BALANCE SHAFT

- Remove the balance shaft from the crankcase. See Figure 9-40.

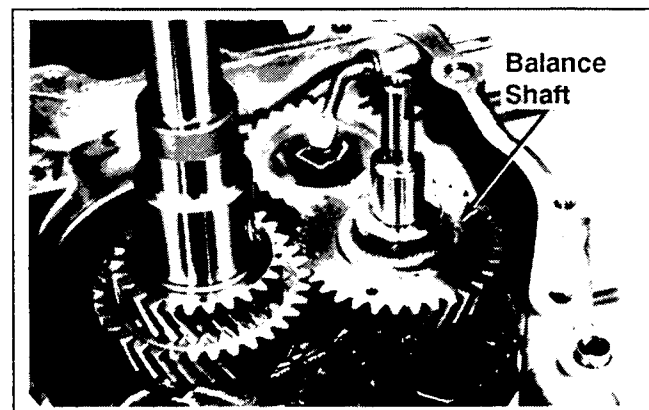

Figure 9-40. Removing Balance Shaft.

REMOVE CONNECTING ROD AND PISTON

- Remove the two hex flange screws and connecting rod cap. See Figure 9-41.

SECTION 9 DISASSEMBLY

NOTE: If a carbon ridge is present at the top of the bore, use a ridge reamer tool to remove it before attempting to remove the piston.

2. Carefully push the connecting rod and the piston away from the crankshaft and out of the cylinder bore.

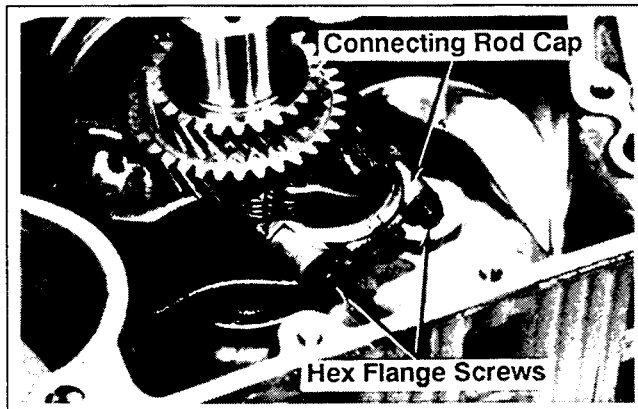

Figure 9-41. Removing Connecting Rod.

REMOVE PISTON FROM CONNECTING ROD

1. Remove the wrist pin retainer and wrist pin. Separate the piston from the connecting rod. See Figure 9-42.

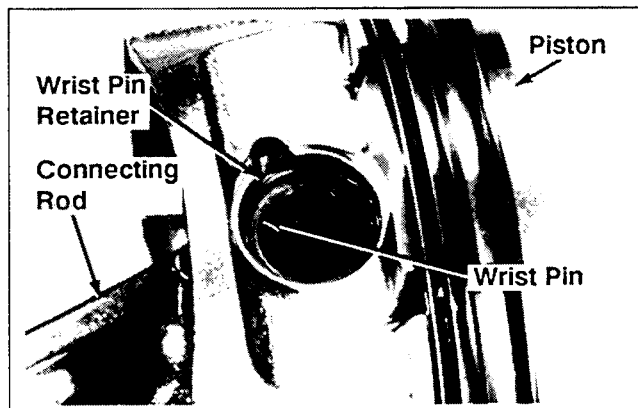

Figure 9-42. Removing Piston From Connecting Rod.

REMOVE PISTON RINGS

1. Remove the top and center compression rings using a ring expander tool. See Figure 9-43.

2. Remove the oil control ring rails, then remove the rails spacer.

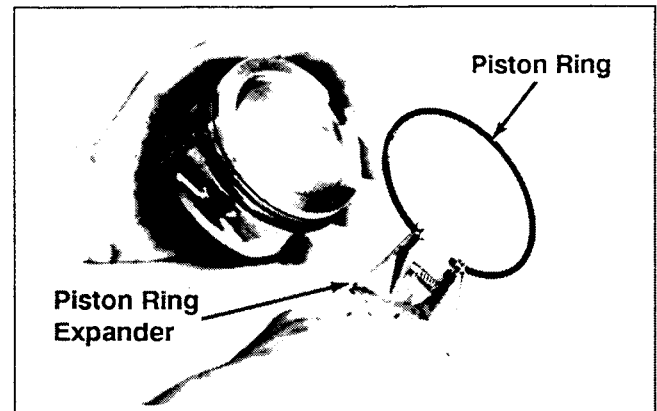

Figure 9-43. Removing Piston Rings.

REMOVE CRANKSHAFT

1. Remove the woodruff key from the flywheel taper end of crankshaft.
2. Remove the crankshaft from the crankcase. See Figure 9-44.

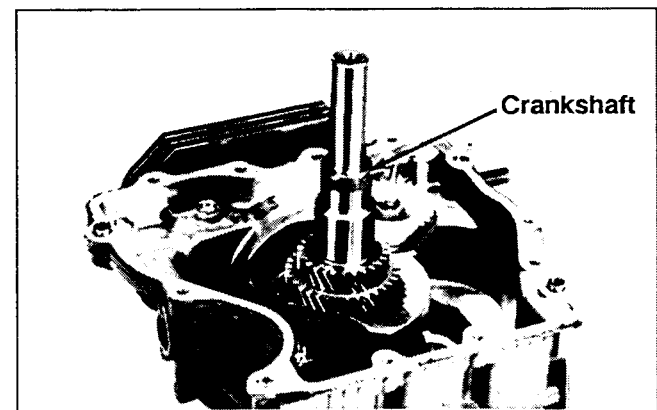

Figure 9-44. Removing Crankshaft.

REMOVE FLYWHEEL END OIL SEAL AND BEARING

1. Remove the oil seal from crankcase.
2. Remove the bearing from the crankcase using handle #NU-4747 and bearing remover #KO-1029. See Figure 9-45.

SECTION 9 DISASSEMBLY

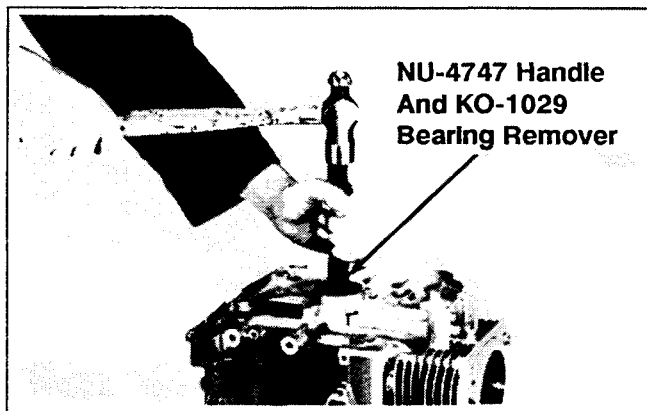

Figure 9-45. Removing Crankshaft Bearing.

REMOVE GOVERNOR CROSS SHAFT AND GOVERNOR GEAR

1. Remove the hitch pin and plain washer from governor cross shaft. See Figure 9-46.
2. Remove the cross shaft and plain washer from the crankcase.

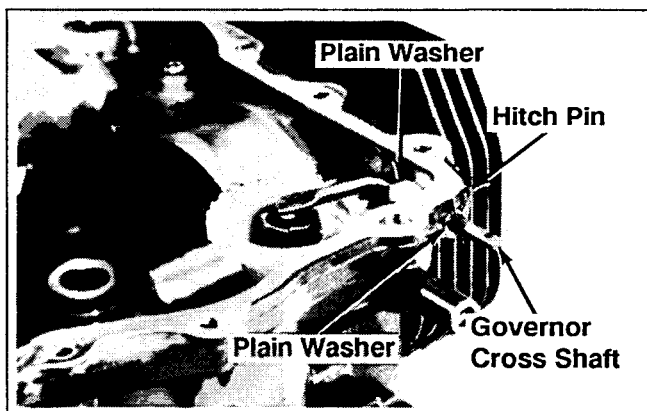

Figure 9-46. Removing Governor Cross Shaft.

3. Remove the governor cross shaft oil seal from the crankcase. See Figure 9-47.

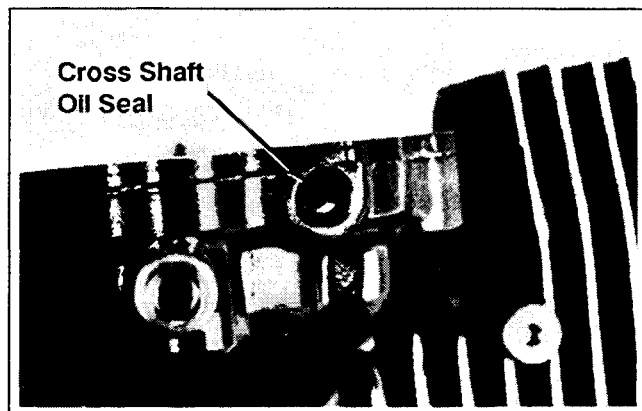

Figure 9-47. Removing Cross Shaft Oil Seal.

4. If necessary, remove the governor gear and regulating pin. See Figure 9-48.

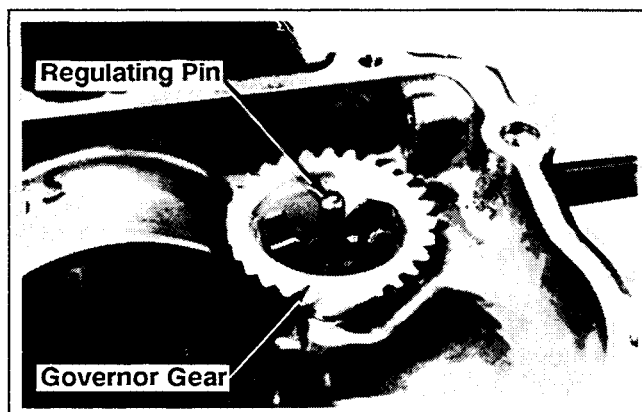

Figure 9-48. Removing Governor Gear.

NOTE: The governor gear is held onto the governor gear shaft by small molded tabs in the gear. When the gear is removed from the shaft these tabs are destroyed. This will require replacement of the gear; therefore, remove the gear only if absolutely necessary (such as when reboring, doing major engine rebuilding, etc.).

SECTION 10 INTERNAL COMPONENTS

This section covers the operation, inspection, and repair/reconditioning of major internal engine components. The following components are not covered in this section. They are covered in sections of their own:

- Air Cleaner, *Section 4*
- Carburetor & External Governor, *Section 5*
- Retractable Starter, *Section 7*
- Ignition, Charging, & Electric Starter, *Section 8*

Clean all parts thoroughly. Only clean parts can be accurately inspected and gauged for wear or damage. There are many commercially available cleaners that will quickly remove grease, oil, and grime from engine parts. When such a cleaner is used, follow the manufacturer's instructions and safety precautions carefully.

Make sure all traces of the cleaner are removed before the engine is reassembled and placed into operation. Even small amounts of these cleaners can quickly break down the lubricating properties of engine oil.

Refer to A Guide To Engine Rebuilding (TP-2150) for additional information. Measurement Guide (TP-2159-A) and Engine Evaluation Record (TP-2096-B) are also available; use these to record inspection results.

AUTOMATIC COMPRESSION RELEASE (ACR)

This engine is equipped with an **Automatic Compression Release (ACR)** mechanism. ACR lowers compression at cranking speeds to make starting easier.

Operation

The ACR mechanism consists of a lever and control pin assembly attached to the gear on the camshaft. At cranking speeds (700 RPM or lower), the control pin protrudes above the exhaust cam lobe. This pushes the exhaust valve off its seat during the first part of the

compression stroke. The reduced compression results in an effective compression ratio of about 2:1 during cranking.

After starting, engine speed increases to over 700 RPM. Centrifugal force moves the lever and the control pin drops into the recess in the exhaust cam lobe. When in the recess, the control pin has no effect on the exhaust valve and the engine operates at full power.

When the engine is stopped, the spring returns the lever and control pin assembly to the compression release position ready for the next start.

SECTION 10

INTERNAL COMPONENTS

Benefits

Because of the reduced compression at cranking speeds, several important benefits are obtained:

1. Manual (retractable) starting is much easier. Without ACR, manual starting would be virtually impossible.
2. Electric start models can use a starter and battery size that are practical for the applications in which these engines are used.
3. ACR eliminates the need for a spark retard/advance mechanism. A spark retard/advance mechanism would be required on engines without ACR to prevent the "kickback" that would occur during starting. ACR eliminates this "kickback" making manual starting safer.
4. The choke control setting is less critical with ACR. In the event of flooding, excess fuel is blown out the opened exhaust valve and does not hamper starting.
5. Engines with ACR start much faster in cold weather than engines without ACR.
6. Engines with ACR can be started with spark plugs that are worn or fouled. Engines without ACR probably could not be started with those same spark plugs.

CAMSHAFT

Inspection And Service

Inspect the gear teeth of the camshaft. If the teeth are badly worn, chipped, or some are missing, replacement of the camshaft will be necessary.

CRANKSHAFT

Inspection And Service

Inspect the gear teeth of the crankshaft. If the teeth are badly worn, chipped, or some are missing, replacement of the crankshaft will be necessary.

Inspect the crankshaft bearings for scoring, grooving, etc. Do not replace bearings unless they show signs of damage or are out of running clearance specifications. If the crankshaft turns easily and noiselessly, and there is no evidence of scoring, grooving, etc., on the races or bearing surfaces, the bearings can be reused.

Inspect the crankshaft keyways. If worn or chipped, replacement of the crankshaft will be necessary.

Inspect the crankpin for score marks or metallic pickup. Slight score marks can be cleaned with crocus cloth soaked in oil. If wear limits, as stated in "Specifications and Tolerances" are exceeded, it will be necessary to either replace the crankshaft or regrind the crankpin to **0.25 mm (0.010 in)** undersize. If reground, a **0.25 mm (0.010 in)** undersize connecting rod (big end) must then be used to achieve proper running clearance. Measure the crankpin for size, taper, and out-of-round.

NOTE: If the crankpin is reground, visually check to ensure that the fillet blends smoothly with the crankpin surface. See Figure 10-1.

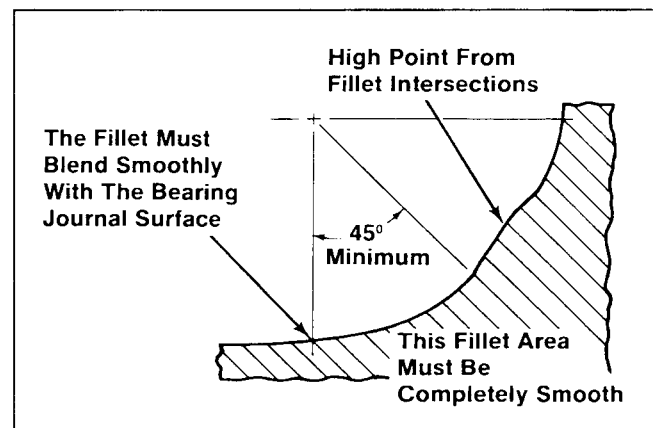

Figure 10-1. Crankpin Fillets.

NOTE: When grinding a crankshaft, grinding stone deposits can get caught in oil passages which could cause severe engine damage. Remove the sealing plug each time the crankshaft is ground to provide easy access for cleaning any grinding deposits that may collect in the oil passages.

CRANKCASE

Inspection And Service

Check all gasket surfaces to make sure they are free of gasket fragments. Gasket surfaces must also be free of deep scratches or nicks.

Check the cylinder bore wall for scoring. In severe cases, unburned fuel can cause scuffing and scoring of the cylinder wall. It washes the necessary lubricating oils off the piston and cylinder wall. As raw fuel seeps down the cylinder wall, the piston rings make metal to metal contact with the wall. Scoring of the cylinder wall can also be caused by localized hot spots resulting from blocked cooling fins or from inadequate or contaminated lubrication.

If the cylinder bore is badly scored, excessively worn, tapered, or out of round, resizing is necessary. Use an inside micrometer to determine amount of wear (refer to the "Specifications, Tolerances, And Special Torque Values", in Section 1), then select the nearest suitable oversize of either **0.25 mm (0.010 in)** or **0.50 mm (0.020 in)**. Resizing to one of these oversizes will allow usage of the available oversize piston and ring assemblies. Initially, resize using a boring bar, then use the following procedures for honing the cylinder.

Honing

While most commercially available cylinder hones can be used with either portable drills or drill presses, the use of a low speed drill press is preferred as it facilitates more accurate alignment of the bore in relation to the crankshaft crossbore. Honing is best accomplished at a drill speed of about **250 RPM** and **60 strokes** per minute. After installing coarse stones in hone, proceed as follows:

1. Lower hone into bore and after centering, adjust so that the stones are in contact with the cylinder wall. Use of a commercial cutting-cooling agent is recommended.

2. With the lower edge of each stone positioned even with the lowest edge of the bore, start drill and honing process. Move the hone up and down while resizing to prevent the formation of cutting ridges. Check the size frequently.

NOTE: Measure the piston diameter and resize the bore to the piston to obtain the specified running clearances. Keep in mind the temperatures caused by honing may cause inaccurate measurements. Make sure the bore is cool when measuring.

3. When the bore is within **0.064 mm (0.0025 in)** of desired size, remove the coarse stones and replace with burnishing stones. Continue with the burnishing stones until within **0.013 mm (0.0005 in)** of desired size and then use finish stones (220–280 grit) and polish to final size. A cross-hatch should be observed if honing is done correctly. The crosshatch should intersect at approximately **23–33°** off the horizontal. Too flat of an angle could cause the rings to skip and wear excessively, too steep of an angle will result in high oil consumption (refer to Figure 10–2).

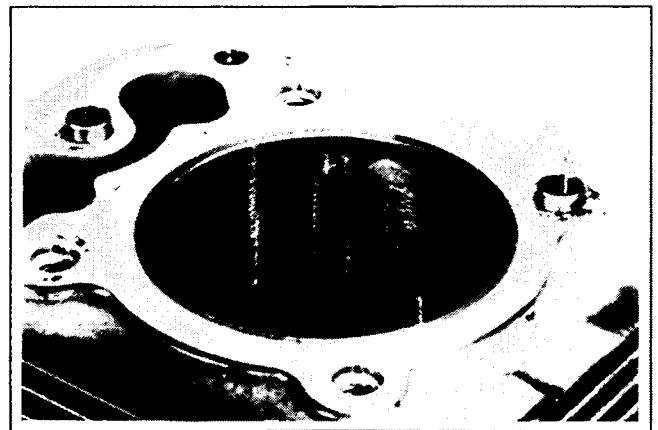

Figure 10–2. Cylinder Bore Crosshatch After Honing.

SECTION 10

INTERNAL COMPONENTS

4. After resizing, check the bore for roundness, taper, and size. Use an inside micrometer, telescoping gauge, or bore gauge to take measurements. The measurements should be taken at three locations in the cylinder – at the top, middle, and bottom. Two measurements should be taken (perpendicular to each other) at each of the three locations.

Measuring Piston-To-Bore Clearance

Before installing the piston into the cylinder bore, it is necessary that the clearance be accurately checked. This step is often overlooked, and if the clearances are not within specifications, engine failure will usually result.

NOTE: Do not use a feeler gauge to measure piston-to-bore clearance—it will yield inaccurate measurements. Always use a micrometer.

Use the following procedure to accurately measure the piston-to-bore clearance:

1. Use a micrometer and measure the diameter of the piston **6 mm (0.24 in)** above the bottom of the piston skirt and perpendicular to the piston pin. See Figure 10-3.

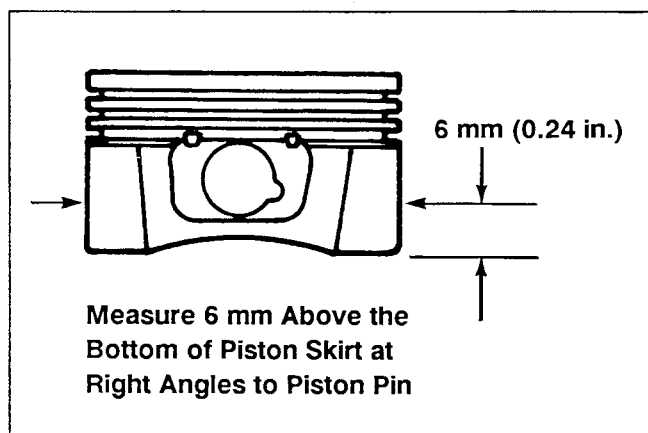

Figure 10-3. Measuring Piston Diameter.

2. Use an inside micrometer, telescoping gauge, or bore gauge and measure the cylinder bore. Take the measurement approximately **63.5 mm (2.5 in)** below the top of the bore and perpendicular to the piston pin.
3. Piston-to-bore clearance is the difference between the bore diameter and the piston diameter (step 2 minus step 1).

FLYWHEEL

Inspection

Inspect the flywheel for cracks, and the flywheel keyway for damage. Replace flywheel if cracked. Replace the flywheel, the crankshaft, and the key if flywheel key is sheared or the keyway damaged.

Inspect the ring gear for cracks or damage. Kohler does not provide ring gears as a serviceable part. Replace the flywheel if the ring gear is damaged.

CYLINDER HEAD AND VALVES

Inspection And Service

Carefully inspect the valve mechanism parts. Inspect the valve springs and related hardware for excessive wear or distortion. Check the valves and valve seat area or inserts for evidence of deep pitting, cracks, or distortion. Check clearance of the valve stems in guides. See Figure 10-4 for valve details and specifications.

SECTION 10 INTERNAL COMPONENTS

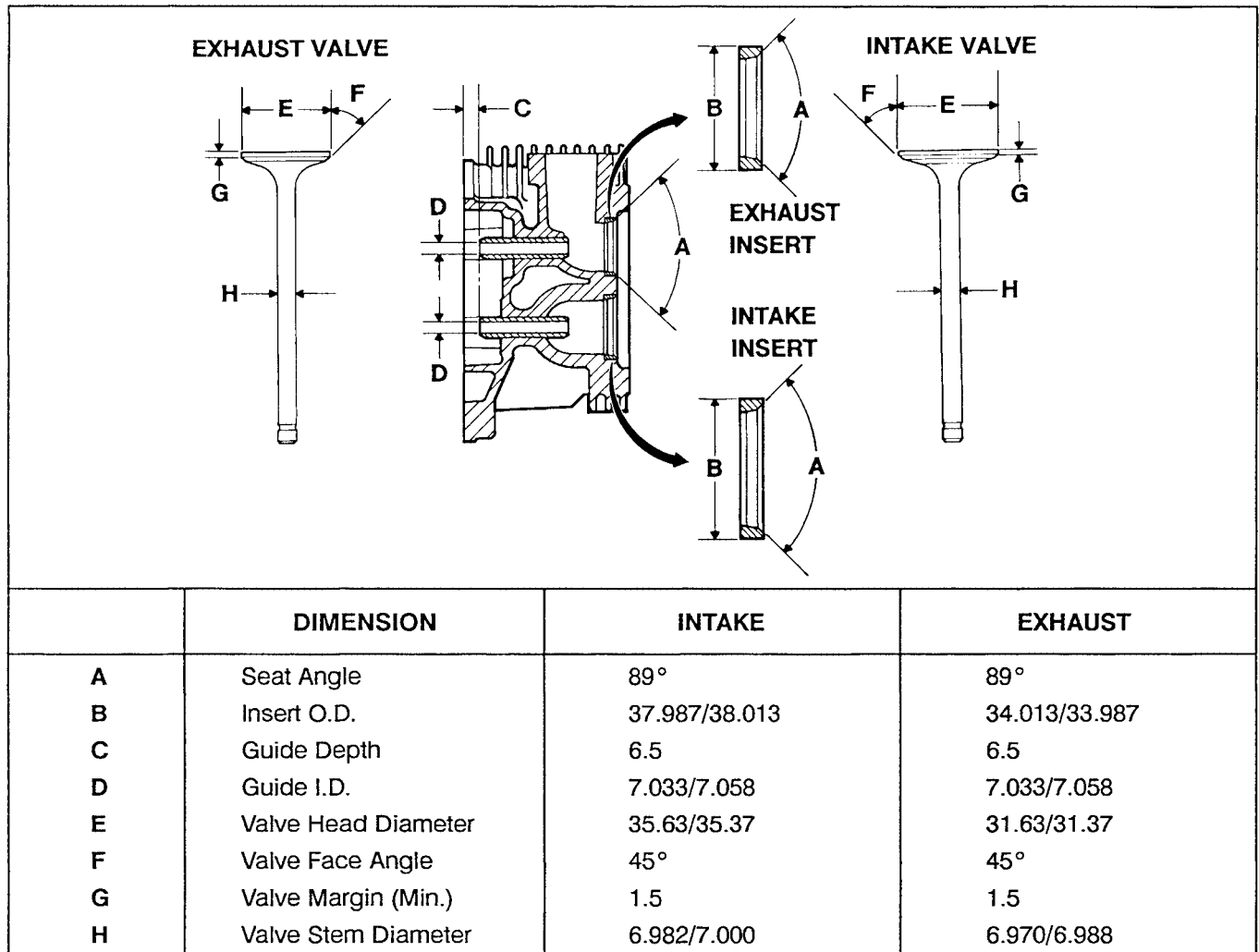

Figure 10-4. Valve Details.

10

Hard starting, or loss of power accompanied by high fuel consumption may be symptoms of faulty valves. Although these symptoms could also be attributed to worn rings, remove and check the valves first. After removal, clean the valve heads, faces, and stems with

a power wire brush. Then, carefully inspect each valve for defects such as warped head, excessive corrosion, or worn stem end. Replace valves found to be in bad condition. A normal valve and valves in bad condition are shown in the accompanying illustrations.

SECTION 10 INTERNAL COMPONENTS

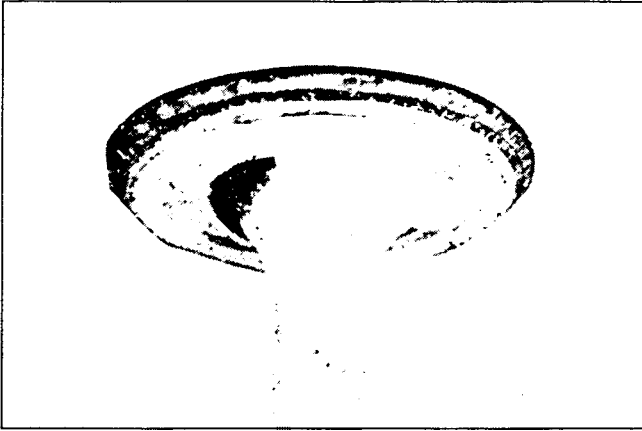

Normal: Even after long hours of operation a valve can be reconditioned and reused if the face and margin are in good shape. If a valve is worn to where the margin is less than 1/32 in do not reuse it. The valve shown was in operation for almost 100 hours under controlled test conditions.

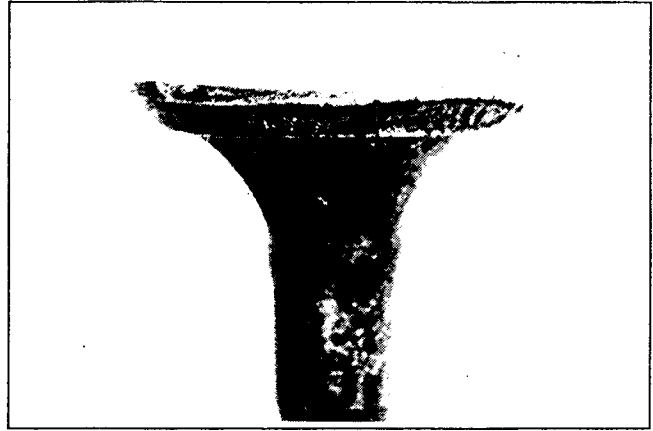

Leakage: A poor grind on face or seat of valve will allow leakage resulting in a burned valve on one side only.

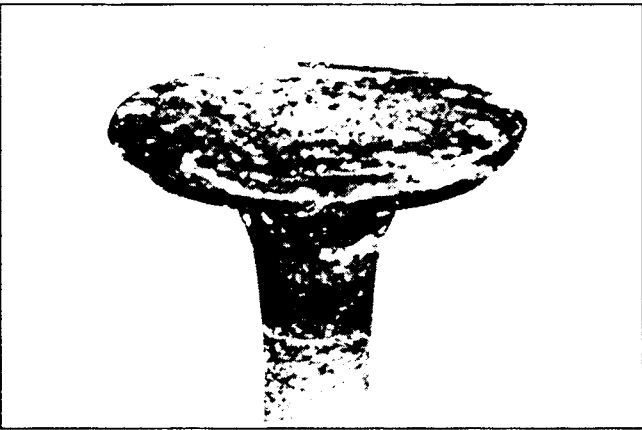

Bad Condition: The valve depicted here should be replaced. Note the warped head; margin damaged and too narrow. These conditions could be attributed to excessive hours or a combination of poor operating conditions.

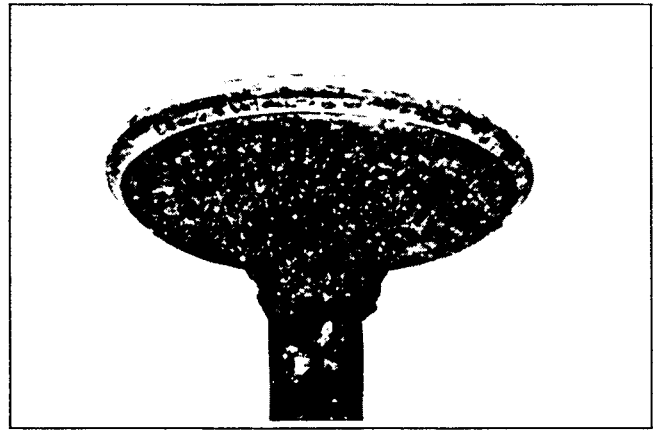

Coking: Coking is normal on intake valves and is not harmful. If the seat is good, the valve could be reused after cleaning.

SECTION 10 INTERNAL COMPONENTS

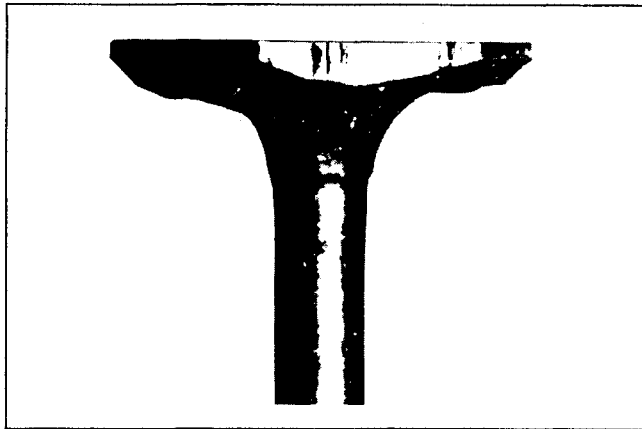

Carbon Cut: Excessive buildup of deposits in the combustion chamber may result in valve damage because deposits can become hard enough to cut the valve. Cleaning of the cylinder head at proper intervals could prevent such damage.

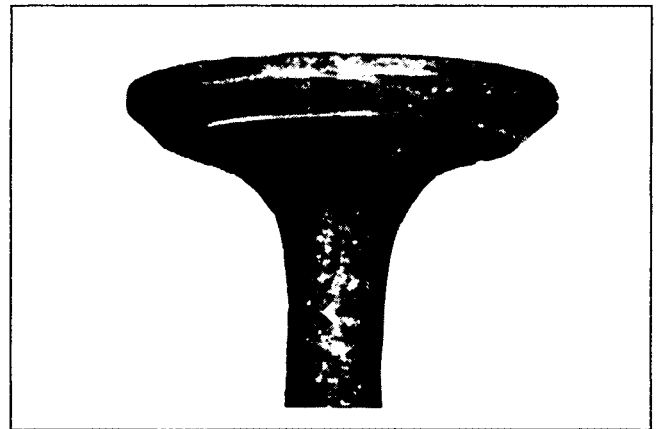

Stem Corrosion: Moisture in fuel or from condensation are the most common causes of valve stem corrosion. Condensation occurs from improper preservation during storage and when engine is repeatedly stopped before it has a chance to reach normal operating temperatures. Replace corroded valves.

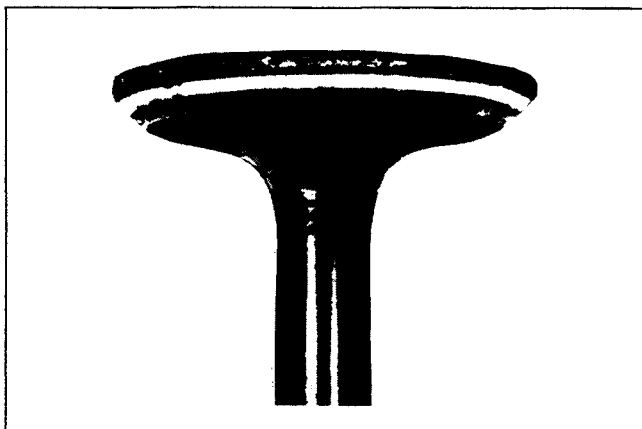

Overheating: An exhaust valve subject to overheating will have a dark discoloration in the area above the valve guide. Worn guides and faulty valve springs may cause this condition. Also check for clogged air intake, blocked fins, and lean fuel mixture when this condition is noted.

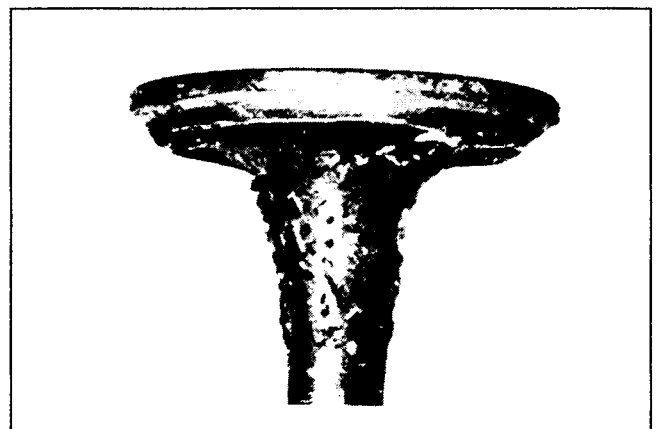

Gum: Gum deposits usually result from using stale gasoline. This condition is often noted in applications where fuel is not drained out of tank during the off season. Gum is a prevalent cause of valve sticking. The cure is to ream the valve guides and clean or replace the valves, depending on their condition.

SECTION 10 INTERNAL COMPONENTS

Valve Guides

If a valve guide is worn beyond specifications, it will not guide the valve in a straight line. This may result in burnt valve faces or seats, loss of compression, and excessive oil consumption.

To check valve guide to valve stem clearance, thoroughly clean the valve guide and, using a split-ball gauge, measure the inside diameter. Then, using an outside micrometer, measure the diameter of the valve stem at several points on the stem where it moves in the valve guide. Use the largest stem diameter to calculate the clearance. If the clearance exceeds **7.134 mm (0.2809 in)** on intake or **7.159 mm (0.2819 in)** on exhaust valve, determine whether the valve stem or the guide is responsible for the excessive clearance.

If the valve stem diameter is within specifications, then recondition the valve guide.

Reconditioning Valve Guide

The valve guides in the cylinder head are not removable. Use a **0.25 mm (0.010 in)** O/S reamer. Tool no. **KO-1026**.

Valve Seat Inserts

Intake valve seats are usually machined into the cylinder head, however, certain applications may specify hard alloy inserts. The valve seats are not replaceable. If the seats become badly pitted, cracked, or distorted, the inserts can be reconditioned.

Use a standard valve seat cutter (see Figure 10-5) and cut seat to dimensions shown in Figure 10-4. (Valve details illustration).

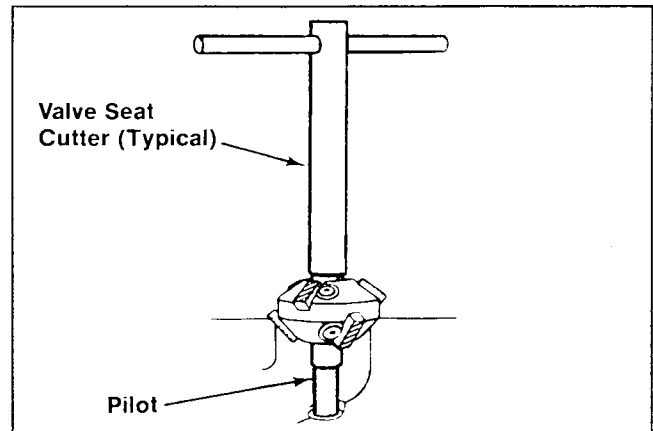

Figure 10-5. Standard Valve Seat Cutter.

Lapping Valves

Reground or new valves must be lapped in, to provide fit. Use a hand valve grinder with suction cup for final lapping. Lightly coat valve face with "fine" grade of grinding compound, then rotate valve on seat with grinder. Continue grinding until smooth surface is obtained on seat and on valve face. Thoroughly clean cylinder head in soap and hot water to remove all traces of grinding compound. After drying cylinder head, apply a light coating of **SAE 10** oil to prevent rusting.

Intake Valve Stem Seal

These engines use valve stem seals on the intake valves. Always use a new seal when valves are removed from cylinder head. The seals should also be replaced if deteriorated or damaged in any way. **Never reuse an old seal.**

PISTONS AND RINGS

Inspection

Scuffing and scoring of pistons and cylinder walls occurs when internal temperatures approach the welding point of the piston. Temperatures high enough to do this are created by friction, which is usually attributed to improper lubrication, and/or overheating of the engine.

SECTION 10 INTERNAL COMPONENTS

Normally, very little wear takes place in the piston boss-piston pin area. If the original piston and connecting rod can be reused after new rings are installed, the original pin can also be reused but new piston pin retainers are required. The piston pin is included as part of the piston assembly—if the pin boss in piston or the pin, are worn or damaged, a new piston assembly is required.

Ring failure is usually indicated by excessive oil consumption and blue exhaust smoke. When rings fail, oil is allowed to enter the combustion chamber where it is burned along with the fuel. High oil consumption can also occur when the piston ring end gap is incorrect because the ring cannot properly conform to the cylinder wall under this condition. Oil control is also lost when ring gaps are not staggered during installation.

When cylinder temperatures get too high, lacquer and varnish collect on pistons causing rings to stick which results in rapid wear. A worn ring usually takes on a shiny or bright appearance.

Scratches on rings and pistons are caused by abrasive material such as carbon, dirt, or pieces of hard metal.

Detonation damage occurs when a portion of the fuel charge ignites spontaneously from heat and pressure shortly after ignition. This creates two flame fronts which meet and explode to create extreme hammering pressures on a specific area of the piston. Detonation generally occurs from using fuels with too low of an octane rating.

Preignition or ignition of the fuel charge before the timed spark can cause damage similar to detonation. Preignition damage is often more severe than detonation damage—often a hole is quickly burned right through the piston dome. Preignition is caused by a hot spot in the combustion chamber from sources such as: glowing carbon deposits, blocked fins, improperly seated valve, or wrong spark plug.

See Figure 10–6 for some common types of piston and ring damage.

SECTION 10 INTERNAL COMPONENTS

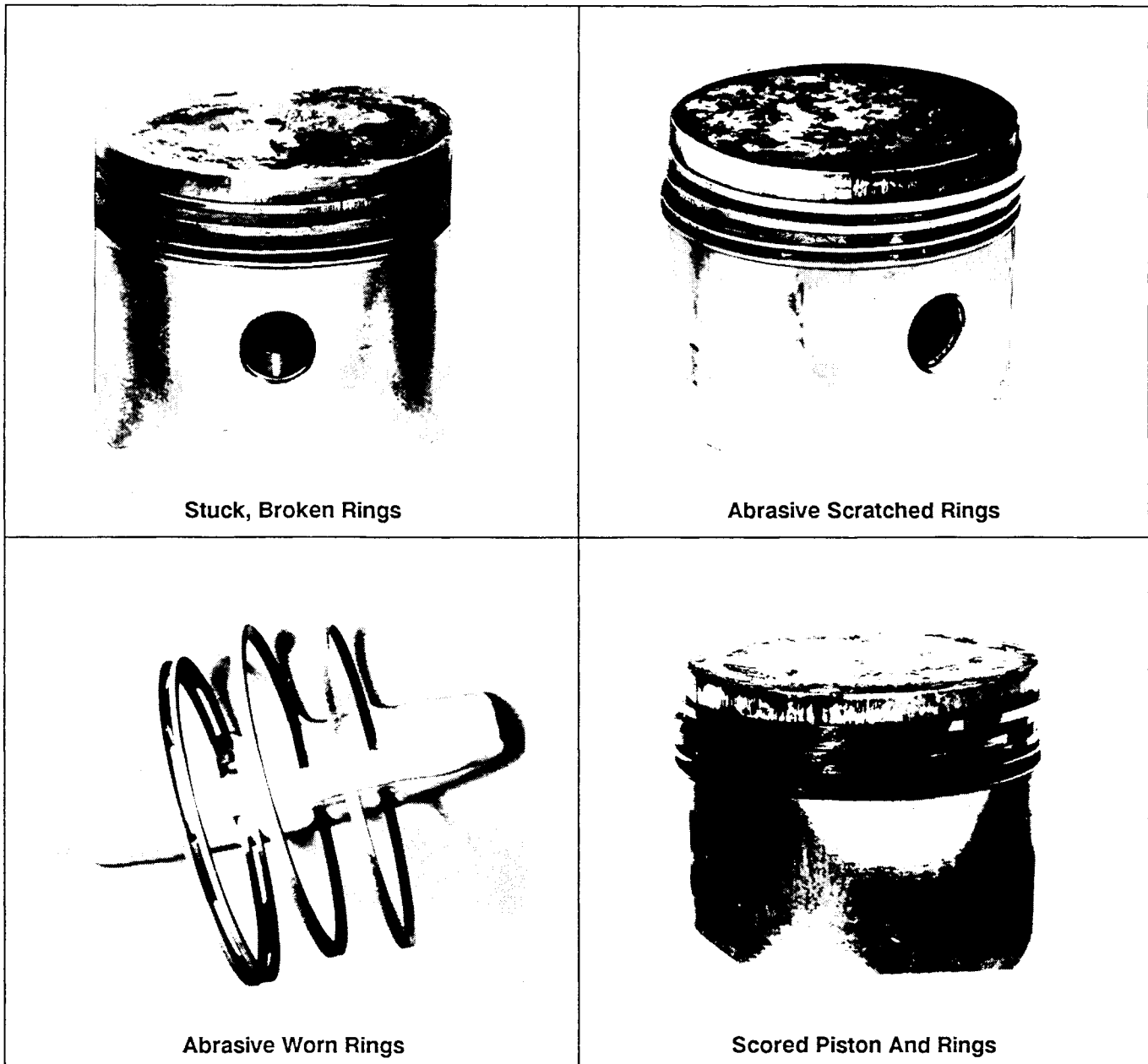

Figure 10-6. Common Types Of Piston And Ring Damage.

Replacement pistons are available in STD bore size, and in **0.25 mm (0.010 in)**, and **0.50 mm (0.020 in)** oversizes. Replacement pistons include new piston ring sets and new piston pins.

Service replacement piston ring sets are also available separately for STD, **0.25 mm (0.010 in)**, and **0.50 mm (0.020 in)**, oversized pistons. Always use

new piston rings when installing pistons. **Never reuse old rings.**

The cylinder bore must be deglazed before service ring sets are used.

Some important points to remember when servicing piston rings:

SECTION 10 INTERNAL COMPONENTS

1. If the cylinder bore does not need reboring and if the old piston is within wear limits and free of score or scuff marks, the old piston may be reused.
2. Remove old rings and clean up grooves. **Never reuse old rings.**
3. Before installing the rings on piston, place the top two rings, each in turn, in its running area in cylinder bore and check end gap (see Figure 10-7). This gap should be **0.75 mm (0.030 in) max.** in a used cylinder bore and **0.3/0.5 mm (0.012/0.020 in)** in a new cylinder bore.
4. After installing the new compression (top and middle) rings on piston, check piston-to-ring side clearance. Maximum recommended side clearance is **0.040/0.105 mm (0.0016/0.0041 in)**. If side clearance is greater than specified, a new piston **must** be used. Refer to Figure 10-8.

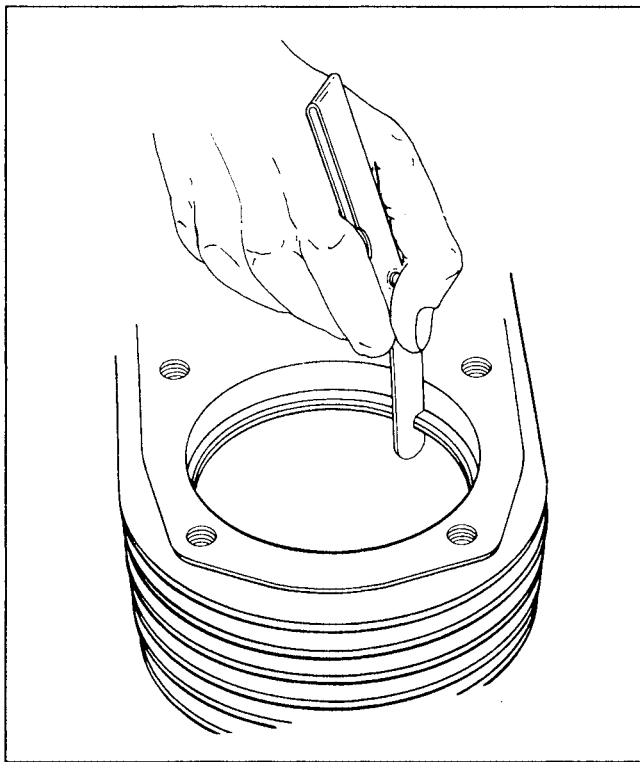

Figure 10-7. Measuring Piston Ring End Gap.



Figure 10-8. Measuring Piston Ring Side Clearance.

Install Piston Rings

To install piston rings, proceed as follows:

NOTE: Rings must be installed correctly. Ring installation instructions are usually included with new ring sets. Follow instructions carefully. Use a piston ring expander to install rings. Install the bottom (oil control) ring first and the top compression ring last. Refer to Figure 10-9.

SECTION 10 INTERNAL COMPONENTS

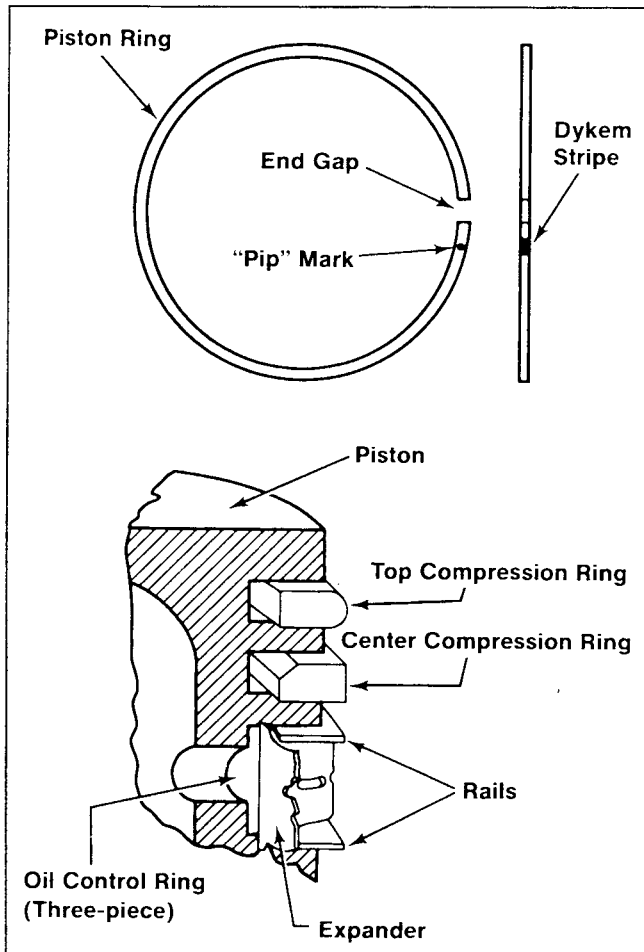

Figure 10-9. Piston Ring Installation.

1. Oil Control Ring (Bottom Groove): Install the expander and then the rails. Make sure the ends of expander are not overlapped.
2. Compression Ring (Center Groove): Install the center ring using a piston ring installation tool. Make sure the "pip" mark is up and the PINK dykem stripe is to the left of end gap.

3. Compression Ring (Top Groove): Install the top ring using a piston ring installation tool. Make sure the "pip" mark is up and the BLUE dykem stripe is to the left of end gap.

CONNECTING RODS

Offset Stepped-cap Connecting Rods are used in all these engines.

Inspection And Service

Check bearing area (big end) for excessive wear, score marks, running and side clearances (Refer to Section 1, "Specifications, Tolerances, And Special Torque Values"). Replace rod and cap if scored or excessively worn.

Service replacement connecting rods are available in STD crankpin size and **0.25 mm (0.010 in)** undersize. The **0.25 mm (0.010 in)** undersized rod can be identified by the drilled hole located in the lower end of the rod shank. Always refer to the appropriate parts information to ensure that correct replacements are used.

OIL PUMP

Inspection And Service

Pump can be checked/replaced without removing closure plate.

Check oil pressure relief valve body, piston, and spring — (refer to Figure 10-10). Piston and body should be free of nicks or burrs. Check spring for wear or distortion. Spring free length should be approximately **0.992 in**. Replace spring if distorted or worn.

SECTION 10 INTERNAL COMPONENTS

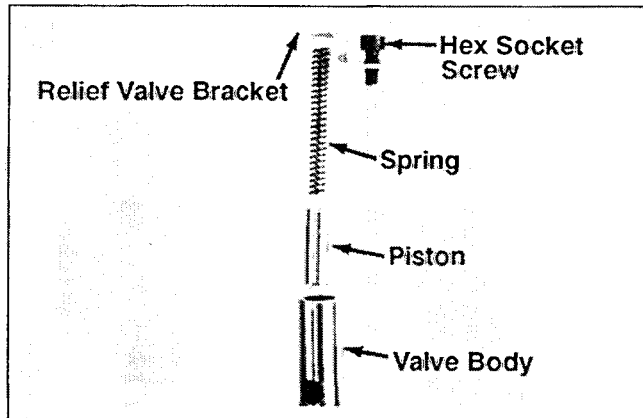

Figure 10-10. Oil Pressure Relief Valve.

GOVERNOR GEAR

Inspection

Inspect the governor gear teeth. Look for any evidence of worn, chipped, or cracked teeth. If one or more of these problems is noted, replace the governor gear.

The governor gear **must** be replaced once it is removed from the engine.

SECTION 11 REASSEMBLY

The following sequence is suggested for complete engine reassembly. This procedure assumes that all components are new or have been reconditioned, and all component subassembly work has been completed. This procedure may be varied to accommodate options or special equipment.

NOTE: Make sure the engine is assembled using all specified torque values, tightening sequences, and clearances. Failure to observe specifications could cause severe engine wear or damage.

Always use new gaskets.

TYPICAL REASSEMBLY SEQUENCE

1. Install flywheel end bearing.
2. Install governor gear and crosshaft.
3. Install crankshaft.
4. Install piston rings.
5. Install piston to connecting rod.
6. Install piston and rod to crankshaft.
7. Install balance shaft.
8. Install hydraulic lifters and camshaft.
9. Check camshaft end play.
10. Install and torque closure plate.
11. Install oil pump.
12. Install pro end oil seal.
13. Install flywheel end oil seal.
14. Install stator and leads.
15. Install flywheel, grass screen and drive cup.
16. Install fuel line.
17. Install and adjust ignition module.
18. Assemble cylinder head.
19. Install cylinder head.
20. Install baffles and blower housing.
21. Install cylinder head baffle.
22. Install valve cover.
23. Install fuel pump.
24. Install electric starter and cover.
25. Install fuel tank.
26. Install rectifier-regulator.
27. Install carburetor.
28. Install and adjust governor arm.
29. Install throttle bracket.
30. Install choke and air cleaner base plate.
31. Install air cleaner element/precleaner and cover.
32. Install oil filter and Oil Sentry.
33. Install dipstick.
34. Install retractable starter.
35. Install muffler and bracket.

INSTALL FLYWHEEL END BEARING

1. Mark the position of one of the crankcase bearing oil galleries on the crankcase. See Figure 11-1.

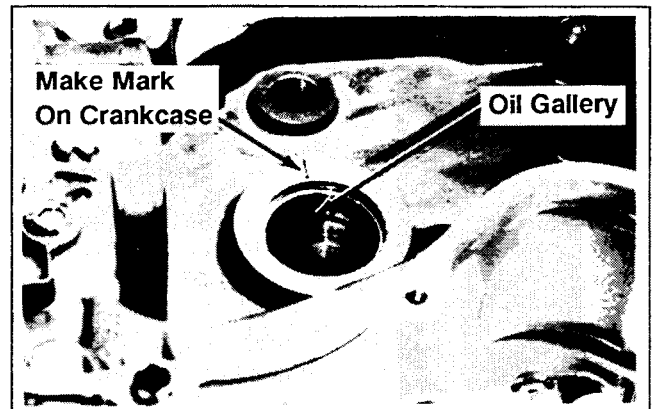

Figure 11-1. Marking Position Of Oil Gallery.

2. Assemble the KO-1028 bearing installer to the NU-4747 handle. Install the sleeve bearing to the bearing installer. Align the oil hole in the bearing with the alignment notch on the installer.

SECTION 11 REASSEMBLY

3. Position the installer/bearing to the bearing bore of crankcase. Make sure the alignment notch of installer and mark on crankcase are aligned.
4. Drive the bearing into the crankcase. Make sure the bearing is installed straight and true in bore and that the tool bottoms against the crankcase.

NOTE: Make sure the hole in the sleeve bearing is aligned with the oil gallery in crankcase. Improper positioning of the bearings can cause engine failure due to lack of lubrication.

INSTALL GOVERNOR GEAR AND CROSS SHAFT

NOTE: Reuse of an old (removed) governor gear is not recommended.

1. Install the thrust washer to governor gear shaft.
2. Position the regulating pin to governor gear/flyweights as shown in Figure 11-2. Slide the governor gear/regulating pin over the governor gear shaft.

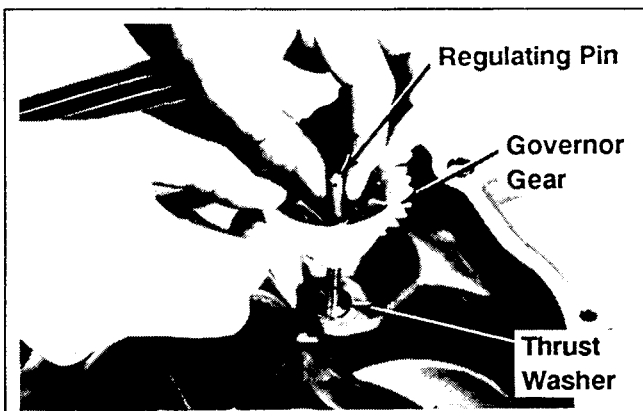

Figure 11-2. Installing Governor Gear.

3. Using the **KO-1030 oil seal installer**, install a new governor cross shaft oil seal into the crankcase. See Figure 11-3.

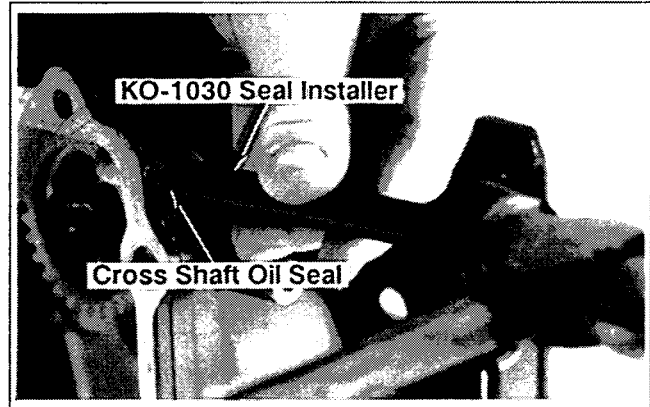

Figure 11-3. Cross Shaft Oil Seal.

4. Install one plain washer to the cross shaft and insert the cross shaft (from inside crankcase) through the crankcase and oil seal. See Figure 11-4.
5. Install one plain washer and hitch pin.

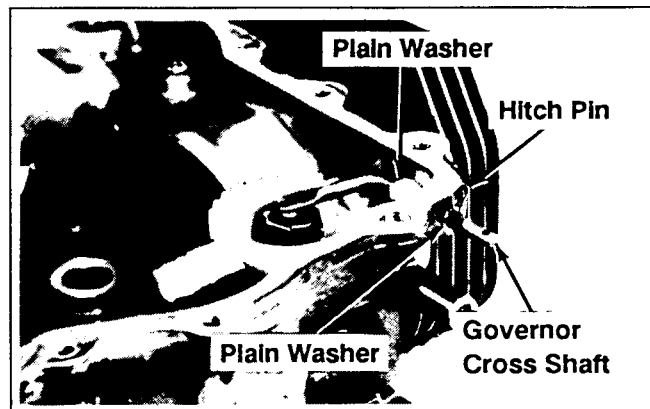

Figure 11-4. Installing Cross Shaft.

INSTALL CRANKSHAFT

1. Lubricate the flywheel end bearing surfaces of the crankshaft and crankcase with engine oil.
2. Insert the crankshaft through the flywheel end bearing. See Figure 11-5.

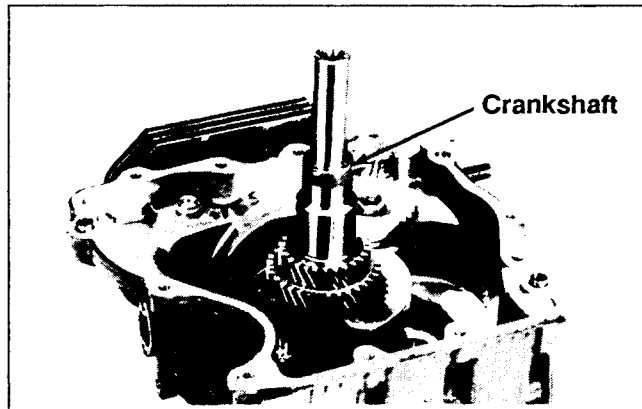

Figure 11-5. Installing Crankshaft.

INSTALL PISTON RINGS

NOTE: For detailed piston inspection procedures and piston ring installation procedure refer to the Section 10—“Internal Components.”

INSTALL PISTON TO CONNECTING ROD

1. Install the piston, connecting rod, piston pin, and piston pin retainers. See Figure 11-6.

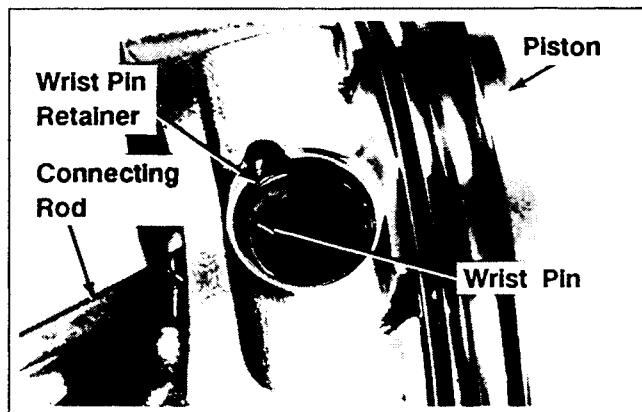

Figure 11-6. Installing Piston To Connecting Rod.

INSTALL PISTON AND CONNECTING ROD

NOTE: Proper orientation of the piston/connecting rod inside the engine is extremely important. Improper orientation can cause extensive wear or damage.

1. Stagger the piston rings in the grooves until the end gaps are 120° apart.
2. Lubricate the cylinder bore, piston, and rings with engine oil. Compress the piston rings using a piston ring compressor. See Figure 11-7.

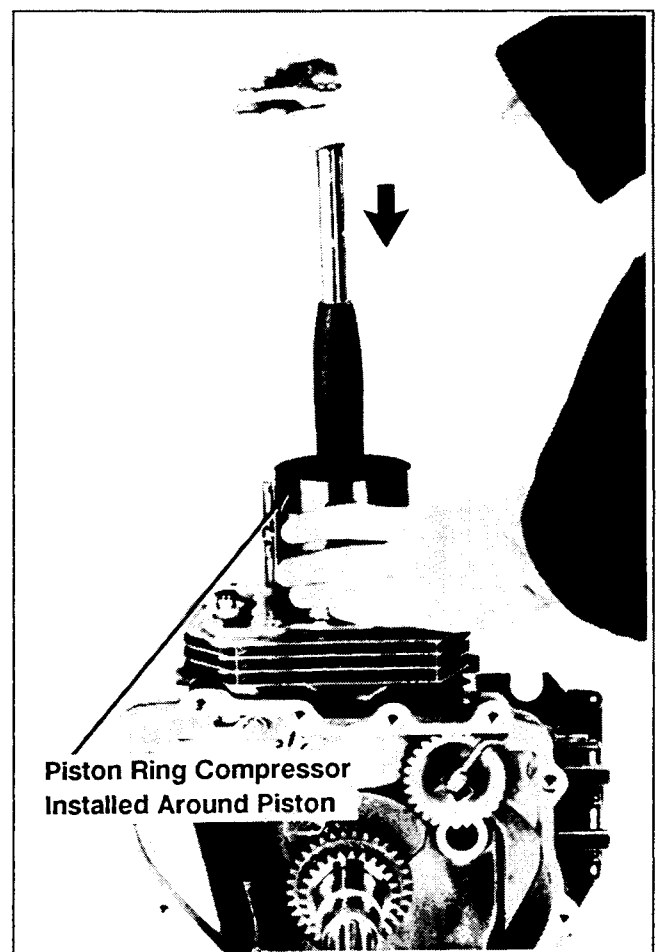

Figure 11-7. Installing Piston And Connecting Rod.

3. Orient the “Fly” mark on piston towards the fly-wheel side of crankcase. See Figure 11-8. Gently push the piston/connecting rod into bore. **Do not pound on the piston.**

SECTION 11 REASSEMBLY

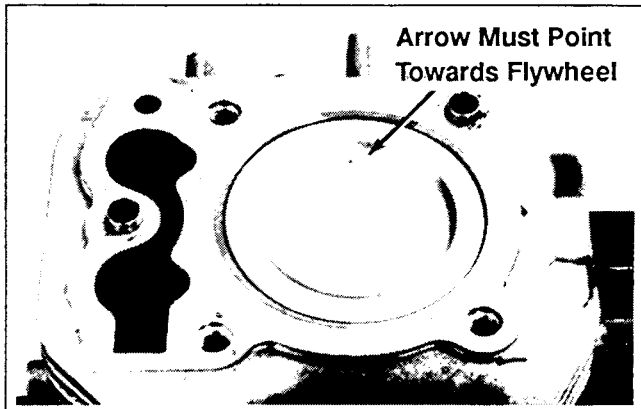

Figure 11-8. Piston Installation Identifier.

4. Lubricate the crankshaft journal and connecting rod bearing surfaces with engine oil. Install the rod cap to connecting rod.
5. Install the hex flange screws and torque in increments to 22.6 N·m (200 lbf·in). See Figure 11-9.
6. Rotate the crankshaft until the piston is at the top dead center in the cylinder bore.

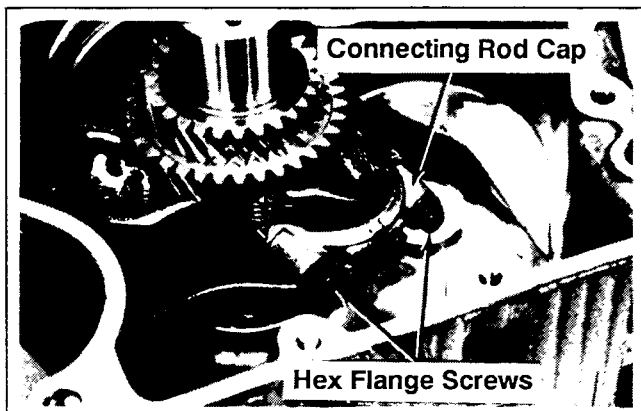

Figure 11-9. Installing Connecting Rod Fasteners.

INSTALL BALANCE SHAFT

1. Lubricate the balance shaft bearing surfaces of crankcase and balance shaft with engine oil.

2. Align the timing mark on the balance shaft gear and the larger gear on crankshaft. Lower the balance shaft into the bearing surface in the crankcase.

Make sure the balance shaft gear, large crankshaft gear and the governor gear teeth mesh and the timing marks are aligned. See Figure 11-10.

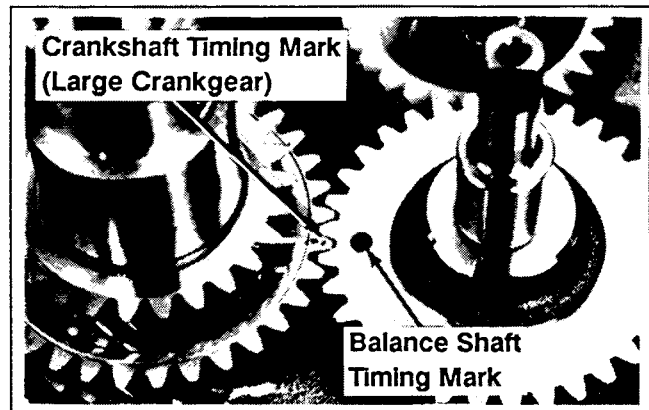

Figure 11-10. Aligning Timing Marks On Crankgear and Balance Shaft Gear.

INSTALL HYDRAULIC LIFTERS AND CAMSHAFT

1. Lubricate the hydraulic lifters and lifter bores in crankcase with engine oil.
2. Install the hydraulic lifters into the appropriate intake or exhaust lifter bore in the crankcase. See Figure 11-11.

NOTE: Install the lifters from inside the crankcase. The chamfered edge of the lifter must be inserted towards the cylinder head gasket surface. The intake hydraulic lifter is farthest from the crankcase gasket surface. The exhaust hydraulic lifter is nearest to the crankcase gasket surface.

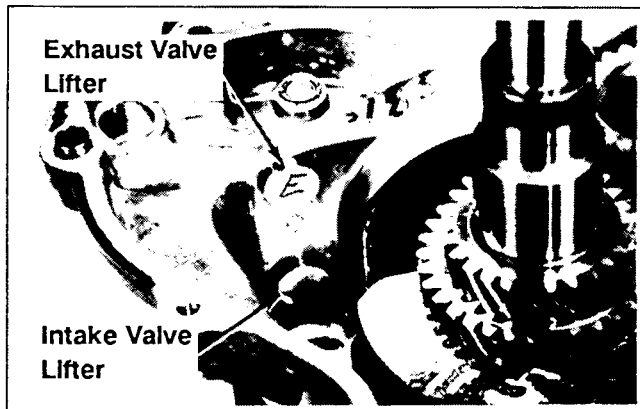

Figure 11-11. Installing Hydraulic Lifters.

3. Lubricate the camshaft bearing surfaces of crankcase and camshaft with engine oil.
4. Align the timing marks on the camshaft gear and the smaller gear on crankshaft. Lower the camshaft into the bearing surface in crankcase.

Make sure the camshaft gear and smaller gear on crankshaft mesh and the timing marks are aligned. See Figure 11-12.

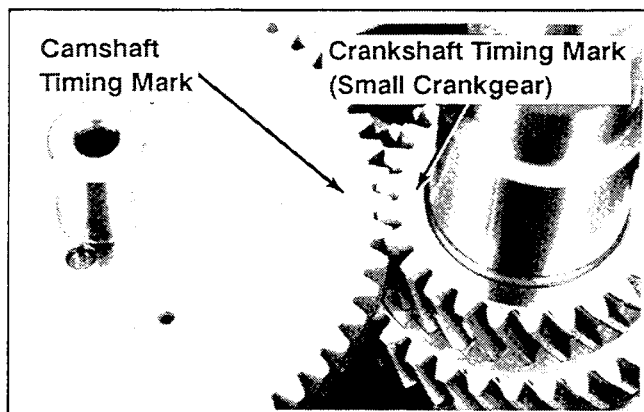

Figure 11-12. Aligning Timing Marks On Crankgear And Camgear.

Determine Camshaft End Play

1. Install the shim spacer, removed during disassembly, to the camshaft.
2. Install the camshaft end play checking tool no. **KO-1031** to the crankcase and camshaft. Secure the tool to the crankcase with the hex flange screws provided. See Figure 11-13.

3. Using a flat feeler gauge, measure the camshaft end play between the shim spacer and the end play checking tool.

Camshaft end play should be **0.076/0.127 mm (0.003/0.005 in)**.

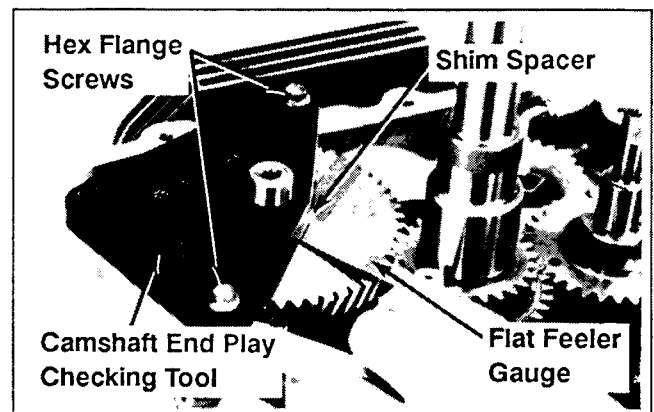

Figure 11-13. Checking Camshaft End Play.

4. If the camshaft end play is not within the specified range, remove the end play checking tool and add, remove, or replace shims as necessary.

Several color coded shims are available:

White:	0.69215/0.73025 mm (0.02725/0.02875 in)
Blue:	0.74295/0.78105 mm (0.02925/0.03075 in)
Red:	0.79375/0.83185 mm (0.03125/0.03275 in)
Yellow:	0.84455/0.88265 mm (0.03325/0.03475 in)
Green:	0.89535/0.99345 mm (0.03525/0.03675 in)
Gray:	0.94615/0.98425 mm (0.03725/0.03875 in)
Black:	0.99695/1.03505 mm (0.03925/0.04075 in)

5. Reinstall the end play checking tool and recheck end play.
6. Repeat steps 4 and 5 until the end play is within the specified range.

INSTALL OIL PRESSURE RELIEF VALVE AND OIL PICKUP

Oil Pressure Relief Valve

1. Place the relief valve body in the cavity of the closure plate.
2. Insert the piston and spring into the body. See Figure 11-14.

SECTION 11 REASSEMBLY

3. Install the bracket and hex flange screw. See Figures 11-14 and 11-15.

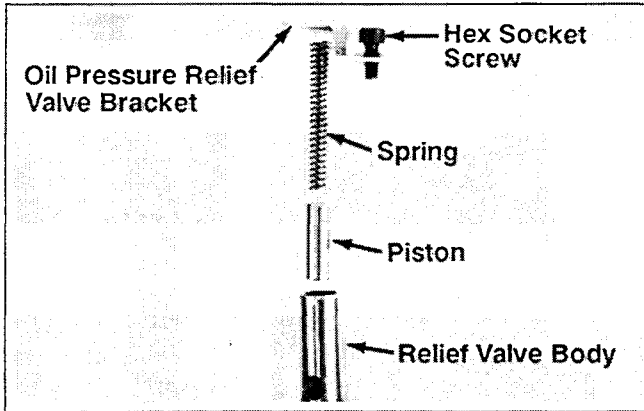

Figure 11-14. Installing Oil Pressure Relief Valve Body, Plunger, And Spring.

Oil Pickup

1. Install the oil pickup, O-ring, clip, and hex flange screw. See Figure 11-15.

NOTE: Lightly grease O-ring and install before oil pickup.

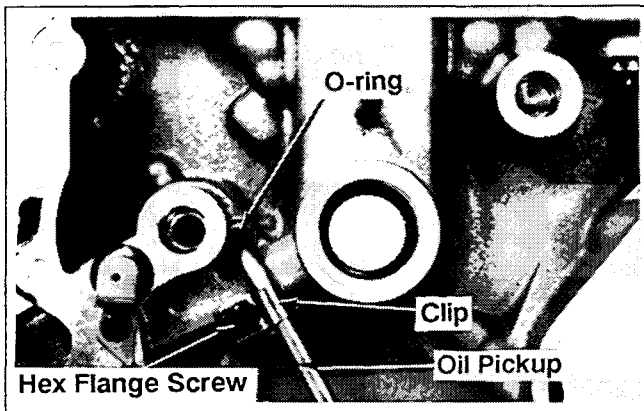

Figure 11-15. Installing Oil Pickup Components.

INSTALL CLOSURE PLATE TO CRANKCASE

RTV silicone sealant is used as a gasket between the closure plate and crankcase. GE Silmate™ type

RTV-1473 or RTV-108 silicone sealant (or equivalent) is recommended.

NOTE: Always use fresh sealant. Using outdated sealant can result in leakage. Refer to Section 2 – “Special Tools” for information on the 52 597 01 silicone sealant dispenser.

1. Prepare the sealing surfaces of the crankcase and closure plate as directed by the sealant manufacturer.

NOTE: Do not scrape the surfaces when cleaning as this will damage the surfaces. This could result in leaks. The use of a gasket removing solvent is recommended.

2. Apply a 1/16” bead of sealant to the *closure plate* as shown in Figure 11-16.

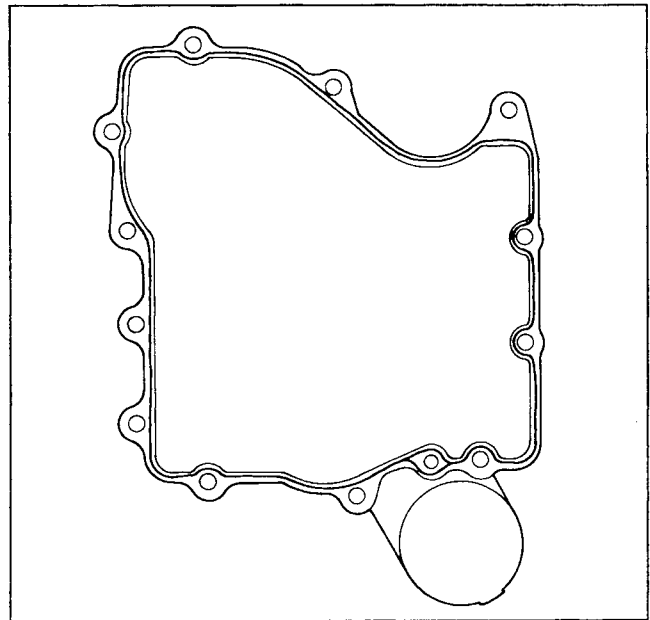

Figure 11-16. Closure Plate Sealant Pattern.

3. Install the closure plate to the crankcase and install the twelve hex flange screws. Tighten the screws hand tight.
4. Torque the fasteners, in the sequence shown in Figure 11-17 to **24.4 N·m (216 lbf·in)**.

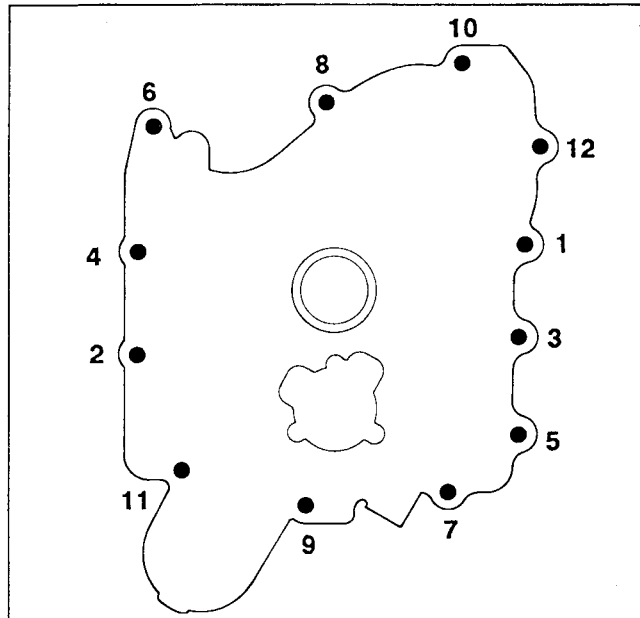

Figure 11-17. Closure Plate Fastener Torque Pattern.

INSTALL OIL PUMP

1. Lubricate the oil pump cavity and oil pump rotors with engine oil. Install the outer and inner oil pump rotors. See Figure 11-18.
2. Install the O-ring in the groove in the closure plate.
3. Install the oil pump cover (machined side towards O-ring). Secure with three hex flange screws. See Figure 11-19.

NOTE: Apply sealant to the oil pump cover hex flange screws to prevent leakage.

Torque the screws as follows:

First Time Installation On A New Closure Plate:
6.2 N·m (55 lbf·in).

Reinstallation On A Used Closure Plate: **4.0 N·m (35 lbf·in).**

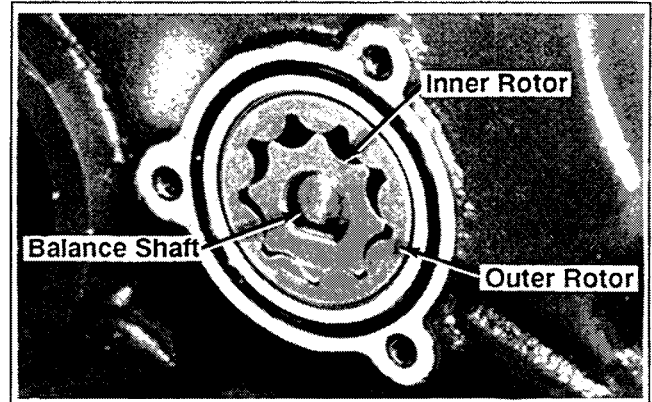

Figure 11-18. Installing Oil Pump Gears And O-ring.

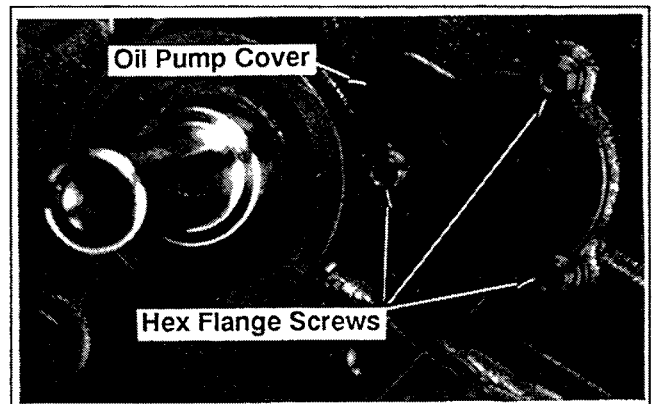

Figure 11-19. Installing Oil Pump Cover.

INSTALL OIL SEALS

1. Slide the seal protector sleeve, no. **KO-1037**, over the crankshaft. Generously lubricate the lips of oil seal with light grease. Slide the oil seal over the sleeve.
2. Use handle no. **KO-1036** and seal driver no. **KO-1027**. Install the seals until the driver bottoms against the crankcase or closure plate. See Figure 11-20.

SECTION 11 REASSEMBLY

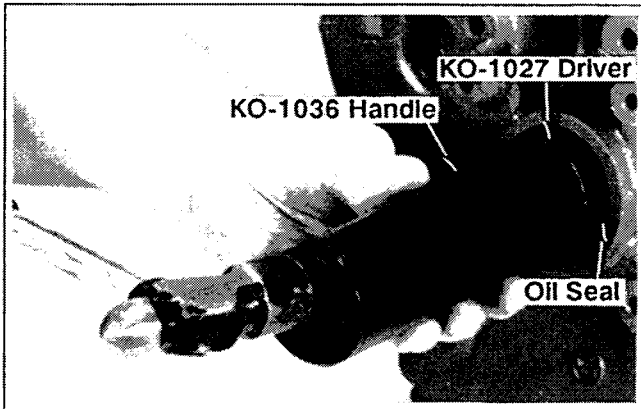

Figure 11-20. Installing Oil Seals.

INSTALL STATOR AND WIRING HARNESS

1. Position the stator leads towards the hole in the crankcase. Insert the stator leads through the hole to the outside of the crankcase. See Figure 11-21.
2. Install the stator using four hex socket head screws.

Torque the screws to **4.0 N·m (35 lbf·in)**.
3. Secure the stator leads to the crankcase with the clip and hex flange screw.
4. Install the connector body to the stator leads.
5. Secure the kill lead to the crankcase with the clip and hex flange screw.

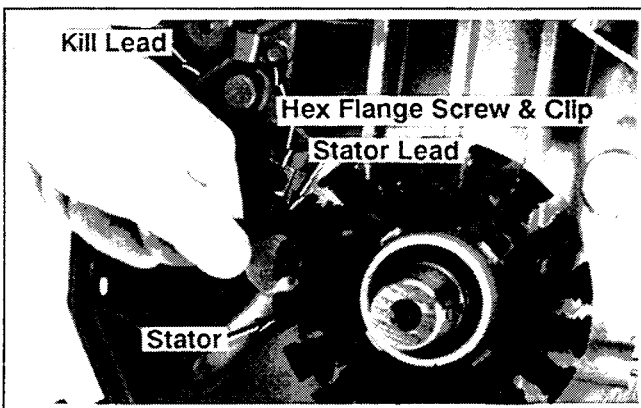

Figure 11-21. Installing Stator.

INSTALL FAN AND FLYWHEEL

WARNING: Damaging Crankshaft And Flywheel Can Cause Personal Injury!



Using improper procedures to install the flywheel can crack or damage the crankshaft and/or flywheel. This not only causes extensive engine damage, but can also cause personal injury, since broken fragments could be thrown from the engine. Always observe and use the following precautions and procedures when installing the flywheel.

NOTE: Before installing the flywheel make sure the crankshaft taper and flywheel hub are clean, dry and completely free of lubricants. The presence of lubricants can cause the flywheel to be over-stressed and damaged when the flange screw is torqued to specification.

NOTE: Make sure the flywheel key is installed properly in the keyway. The flywheel can become cracked or damaged if the key is not installed properly in the keyway.

NOTE: Always use a flywheel strap wrench to hold the flywheel when tightening the flywheel fastener. Do not use any type of bar wedge between the cooling fins or flywheel ring gear, as these parts could become cracked or damaged.

1. Install the fan, spacers and hex flange screws to the flywheel. See Figure 11-22.

Torque the hex flange screws to **9.9 N·m (88 lbf·in)**.

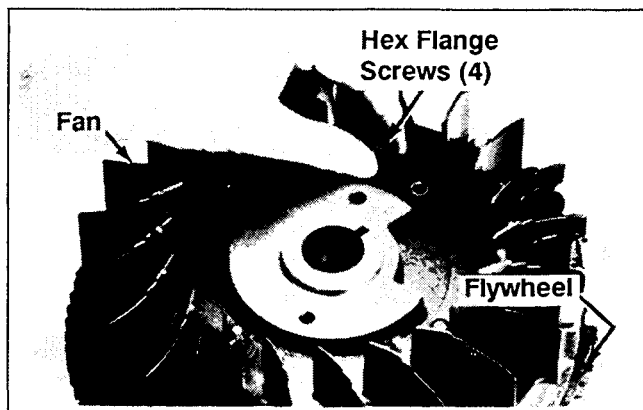

Figure 11-22. Installing Fan To Flywheel.

2. Install the woodruff key into the keyway in the crankshaft.
3. Place the flywheel over the keyway/crankshaft. Install grass screen, drive cup, plain washer (flat side of plain washer towards the drive cup), and the hex flange screw. See Figure 11-23.
4. Hold the flywheel with a strap wrench and torque the hex flange screw to **66.4 N·m (491 lbf·in)**.

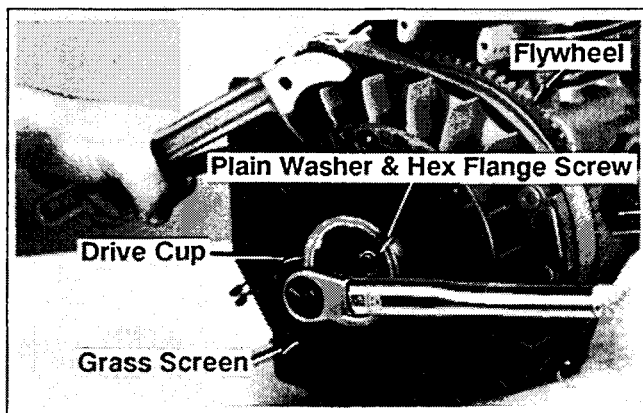

Figure 11-23. Installing Flywheel.

INSTALL FUEL LINE

1. Install the fuel line, clamp and hex flange screw. See Figure 11-24.

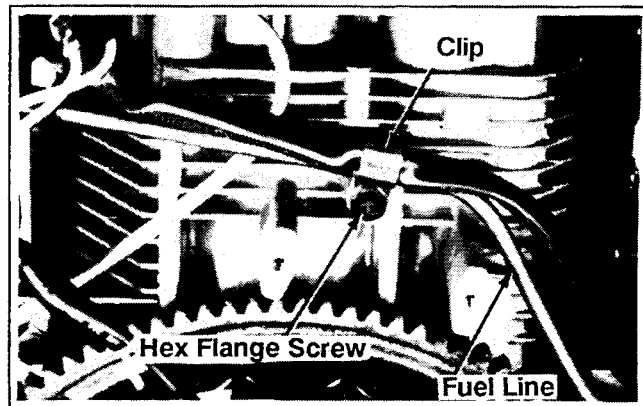

Figure 11-24. Installing Fuel Line.

INSTALL IGNITION MODULE

1. Install the ignition module and hex flange screws to the bosses on crankcase. Move the module as far from the flywheel/magnet as possible. Tighten the hex flange screws slightly.
2. Insert a **10 mm (0.394 in)** flat feeler gauge or shim stock between the magnet and ignition module. See Figure 11-25.

Loosen the hex flange screws so the magnet pulls the module against the feeler gauge.

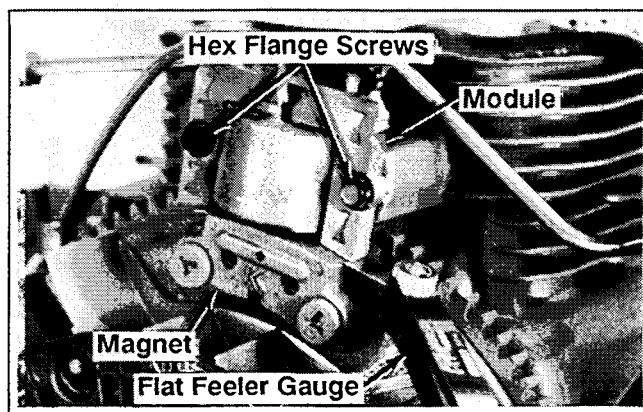

Figure 11-25. Installing Ignition Module.

3. Tighten the hex flange screws as follows:
 First Time Installation On A New Short Block: **6.2 N·m (55 lbf·in)**.
 All Reinstallations: **4.0 N·m (35 lbf·in)**.
4. Rotate the flywheel back and forth; check to make sure the magnet does not strike the module.

SECTION 11 REASSEMBLY

Check the gap with feeler gauge and readjust if necessary.

Final Air Gap: 0.203/0.305 mm (0.008/0.012 in).

5. Connect the kill lead to the tab terminal on ignition module.

REASSEMBLE CYLINDER HEAD COMPONENTS

See Figures 11-26, 11-27, 11-28, and 11-29.

1. Install the rocker bridge to the cylinder head. Make sure the small (counterbored) hole is towards the exhaust port side of the cylinder head.

Secure the rocker bridge with two hex cap screws.

2. Install the intake valve stem seal, intake valve, intake valve spring seat, intake valve spring, and valve spring cap. Compress the valve spring using a valve spring compressor and install the keepers.
3. Install the exhaust valve, exhaust valve rotator, valve spring, and valve spring cap. Compress the valve spring using a valve spring compressor and install the keepers.
4. Position the rocker arms over the valve stems and rocker arm bridge. Insert the pin (from breather reed side) through the rocker bridge and rocker arms.

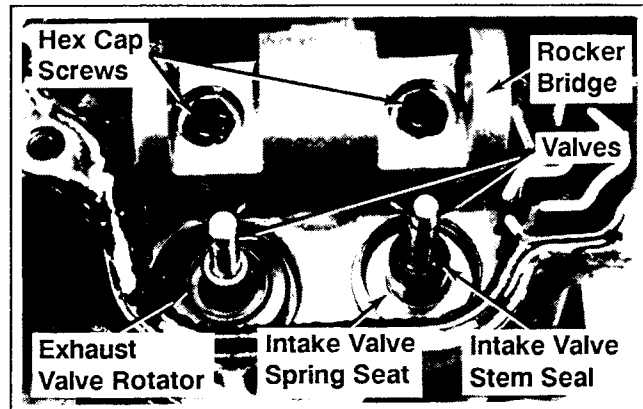

Figure 11-26. Installing Rocker Bridge And Valves.

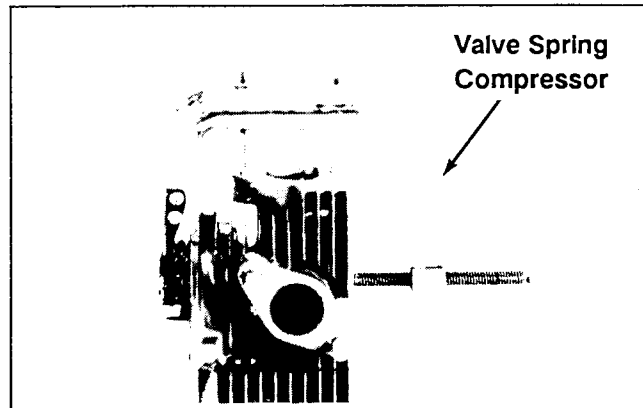

Figure 11-27. Compressing Valve Springs.

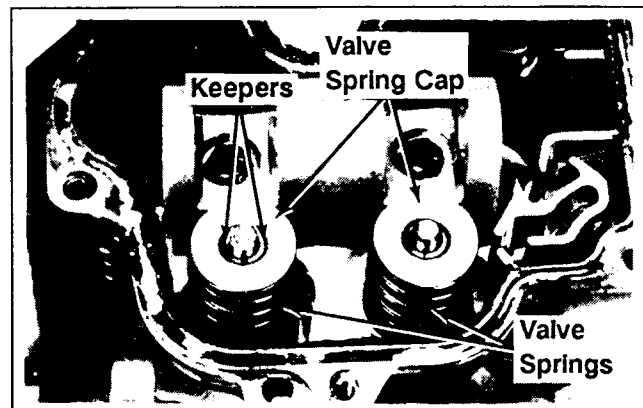

Figure 11-28. Installing Valve Keepers.

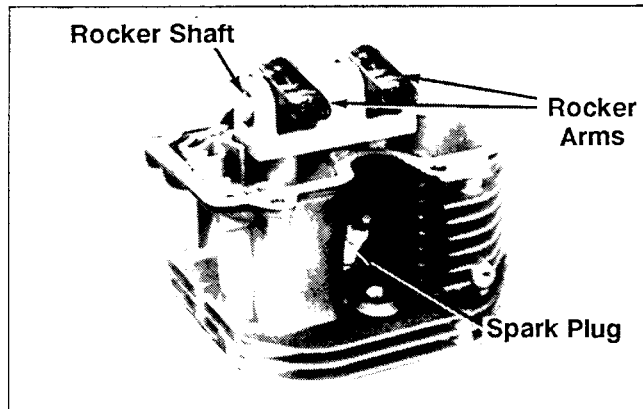

Figure 11-29. Installing Rocker Arms.

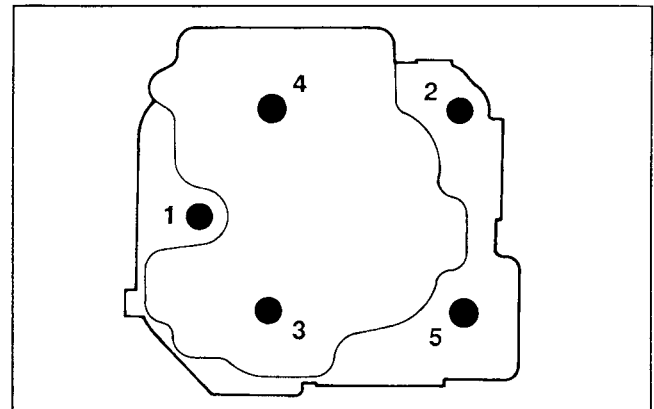

Figure 11-31. Cylinder Head Fastener Tightening Sequence.

INSTALL CYLINDER HEAD

1. Install a new cylinder head gasket.
2. Install the cylinder head spacer (closest to the exhaust port) and hex flange screws. See Figure 11-30.

Torque the screws in increments of 10 lbf-ft in the sequence shown in Figure 11-31 to **40.7 N-m (30 lbf-in)**.

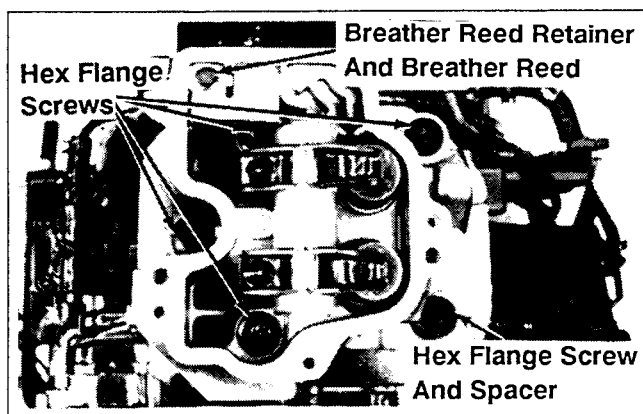

Figure 11-30. Installing Cylinder Head.

3. Install the push rods and compress the valve springs. Snap the push rods underneath the rocker arms. See Figure 11-32.

4. Install the spark plug into the cylinder head.
Torque the spark plug to **38.0/43.4 N-m (28/32 lbf-ft)**.

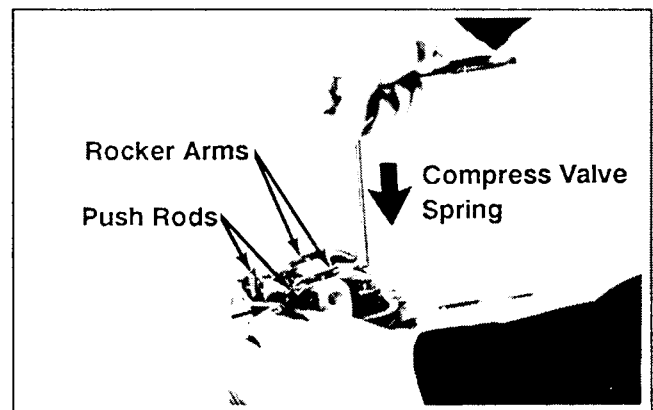

Figure 11-32. Installing Push Rods Under Rocker Arms.

5. Install the breather reed, breather reed retainer, and hex flange screw.

INSTALL BAFFLES AND BLOWER HOUSING

NOTE: Leave all hardware slightly loose until all sheet metal pieces are in position.

1. Install the heat deflector, intake manifold, and gaskets to the cylinder head intake port using two hex socket screws.

Torque the hex socket screws to **9.9 N-m (88 lbf-in)**.

SECTION 11 REASSEMBLY

2. Install the grommet around the high tension lead. Insert the grommet into the slot in the blower housing. Install the blower housing and baffles using hex flange screws. See Figure 11-33.

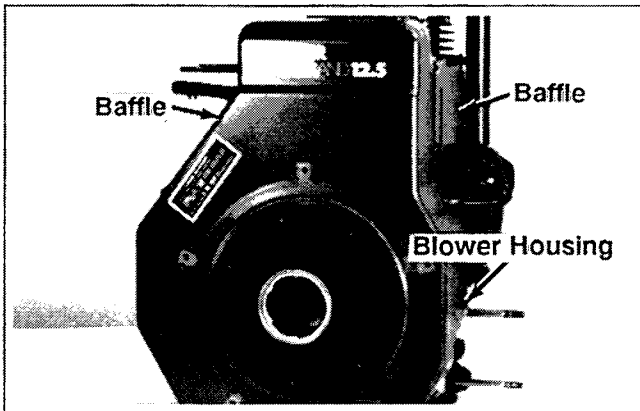

Figure 11-33. Installing Blower Housing And Baffles.

3. Install cylinder head baffle to the cylinder head using hex flange screws.
4. Tighten all hardware.

INSTALL VALVE COVER AND MUFFLER BRACKET

RTV silicone sealant is used as a gasket between the valve cover and crankcase. GE Silmate™ type RTV-1473 or RTV-108 silicone sealant (or equivalent) is recommended.

NOTE: Always use fresh sealant. Using outdated sealant can result in leakage. Refer to Section 2 — “Special Tools” for information on the 52 597 01 silicone sealant dispenser.

1. Prepare the sealing surfaces of the cylinder head and valve cover as directed by the sealant manufacturer.

NOTE: Do not scrape surfaces when cleaning as this will damage the surface and could cause leaks. The use of a gasket removing solvent is recommended.

2. Apply a 1/16” bead of sealant to the cylinder head as shown in Figure 11-34.

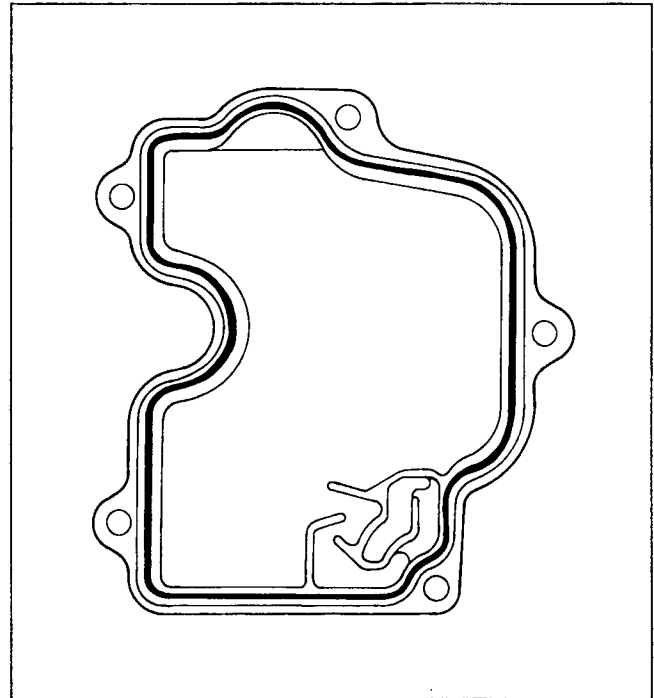

Figure 11-34. Valve Cover Sealant Pattern.

3. Install the valve cover, lift bracket (lifting hole towards flywheel), and two hex flange screws. Install the remaining hex flange screws. See Figure 11-35.

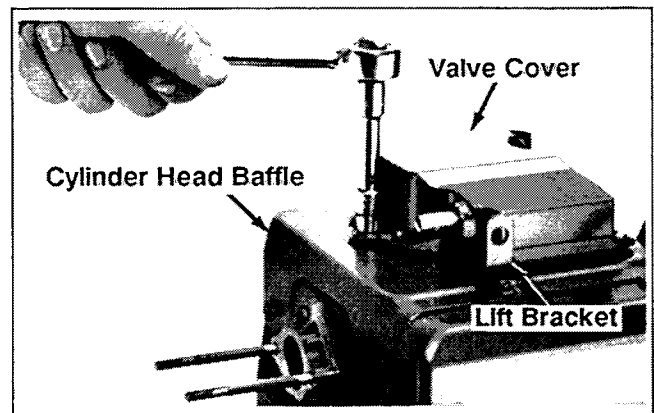

Figure 11-35. Installing Valve Cover.

4. Torque the screws in the sequence shown in Figure 11-36, as follows:

First Time Installation On A New Cylinder Head:
10.7 N·m (95 lbf·in).

All Reinstallations: **7.3 N·m (65 lbf·in).**

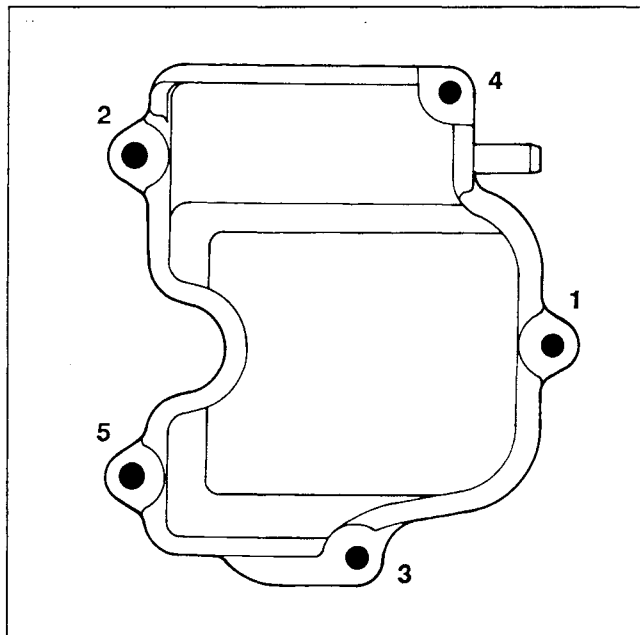

Figure 11-36. Valve Cover Torque Sequence.

INSTALL FUEL PUMP

1. Install the rubber line and two hose clamps to the fuel pump end of the metal fuel line. Secure the rubber fuel line to the steel fuel line with one of the clamps. See Figure 11-37.

2. Install the gasket, fuel pump, and two hex flange screws. Torque the screws as follows:

First Time Installation On A New Short Block: **9.0 N·m (80 lbf-in).**

All Reinstallations: **7.3 N·m (65 lbf-in).**

3. Install the opposite end of the rubber line to the outlet fitting of the fuel pump. Secure the fuel line to the outlet fitting with the other hose clamp.

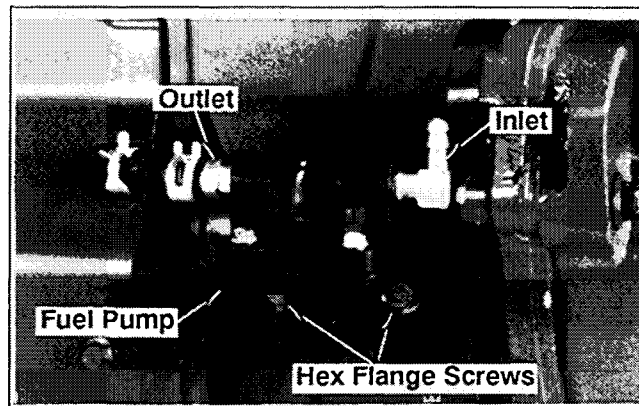

Figure 11-37. Installing Fuel Pump.

INSTALL ELECTRIC STARTER

Electric Starter (Bendix Drive or Solenoid Shift)

1. Install the starter and spacers on the mounting studs. See Figure 11-38.
2. Install the starter cover and the two hex flange screws.
3. Connect the lead to the starter terminal(s).

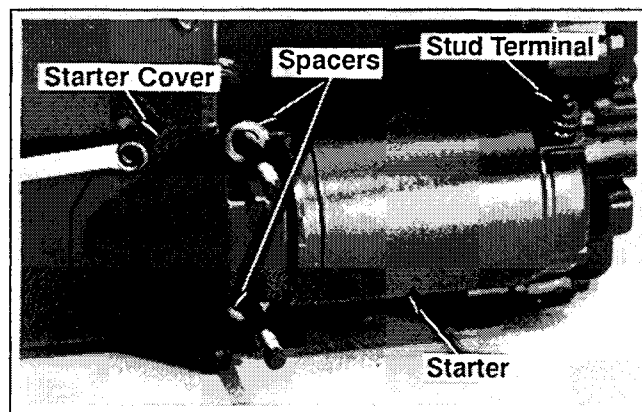

Figure 11-38. Installing Electric Starter.

INSTALL FUEL TANK

1. Connect the fuel hose to the shut-off valve.

SECTION 11 REASSEMBLY

2. Install hex flange screws to upper bracket of fuel tank. Install hex flange nuts to studs in lower bracket of fuel tank. See Figures 11-39 and 11-40.

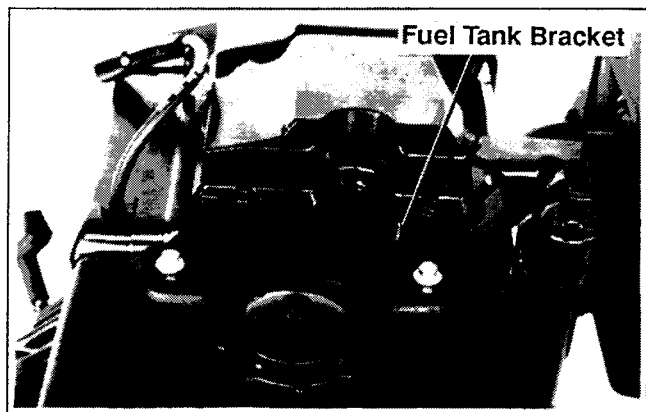

Figure 11-39. Installing Fuel Tank.

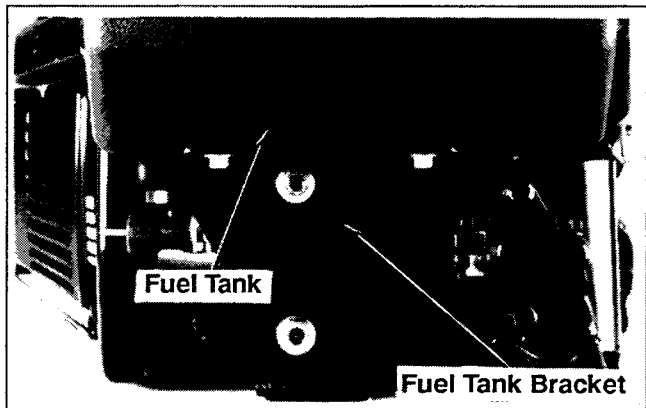

Figure 11-40. Installing Fuel Tank.

INSTALL RECTIFIER-REGULATOR

1. Install the rectifier-regulator and hex flange screws. See Figure 11-41.
2. Install the connector to the rectifier-regulator.

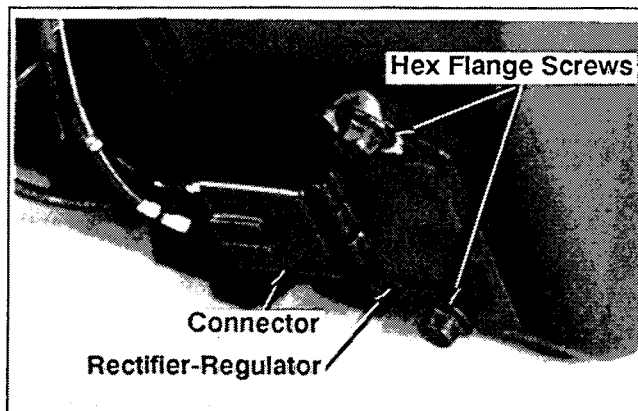

Figure 11-41. Installing Rectifier-Regulator.

INSTALL CARBURETOR AND EXTERNAL GOVERNOR COMPONENTS

1. Install the rubber fuel line and two hose clamps to the metal fuel line. Secure the rubber fuel line to the metal fuel line with one of the hose clamps. See Figure 11-42.

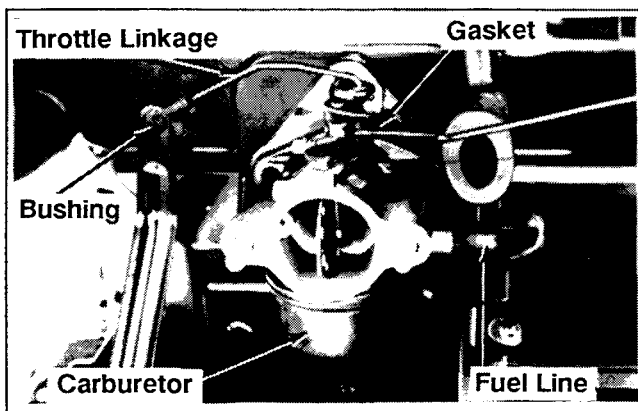

Figure 11-42. Installing Carburetor And External Governor Components.

2. Install the bushing and the throttle linkage to the carburetor throttle lever.

3. Install the gasket and carburetor over the intake studs. Install the free end of the rubber fuel line to the carburetor fuel inlet fitting as the carburetor is inserted over the studs. Secure the fuel line with the other hose clamp.
4. Install the throttle linkage and bushing to governor lever.
5. Install the governor lever to governor cross shaft. Do not tighten the hex nut on the governor lever until the lever is adjusted (step 6).
6. Adjust the governor lever/governor gear. See Figure 11-43.
 - a. Pull the governor lever **away from the carburetor** (wide open throttle).
 - b. Insert a nail in the cross shaft hole or grasp the cross shaft with a pliers and turn the shaft **counterclockwise** as far as it will go.
 - c. Tighten the hex nut securely.

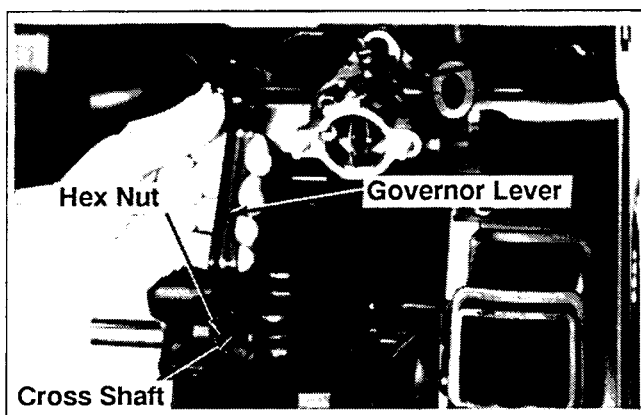

Figure 11-43. Adjusting Governor Lever.

INSTALL THROTTLE BRACKET

1. Install the throttle bracket assembly with two hex flange screws. See Figures 11-44.

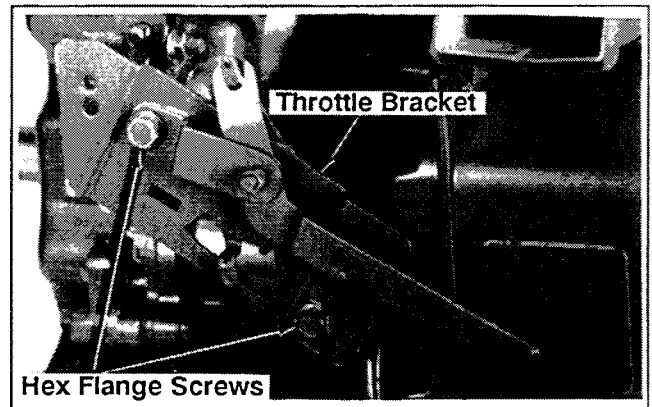

Figure 11-44. Installing Throttle Bracket.

2. Install the governor spring in the appropriate hole in the governor arm and throttle control lever, as indicated in the chart. Note that hole positions are counted from the top of the lever.

RPM should be checked with a tachometer.

HIGH IDLE RPM	GOV. LEVER HOLE #	THROTTLE LEVER HOLE #
3800	6	3
3600	5	1
3400	4	1
3200	3	1
3000	2	1

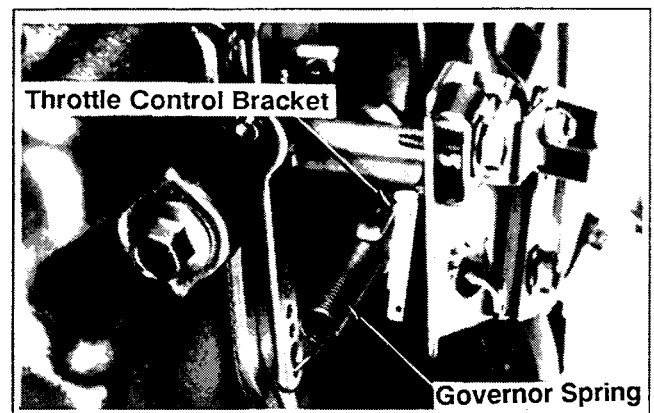

Figure 11-45. Installing Governor Spring.

INSTALL AIR CLEANER

1. Connect choke linkage to the carburetor choke lever. Install the base plate to the studs and connect the breather hose to the rocker arm cover. See Figure 11-46.

SECTION 11 REASSEMBLY

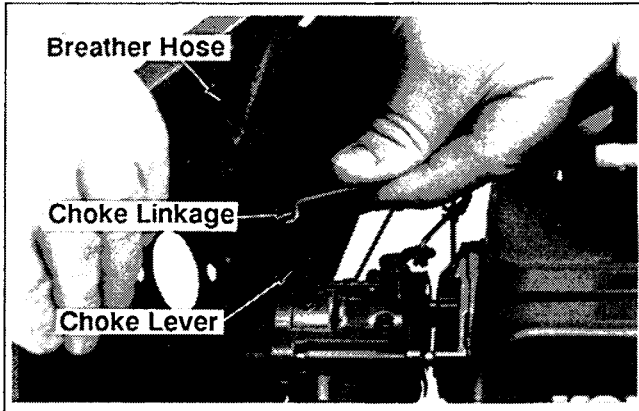

Figure 11-46. Installing Air Cleaner Base Plate.

2. Install the air cleaner base and gasket to the studs and torque the hex flange nuts to 9.9 N·m (88 lbf·in). See Figure 11-47.

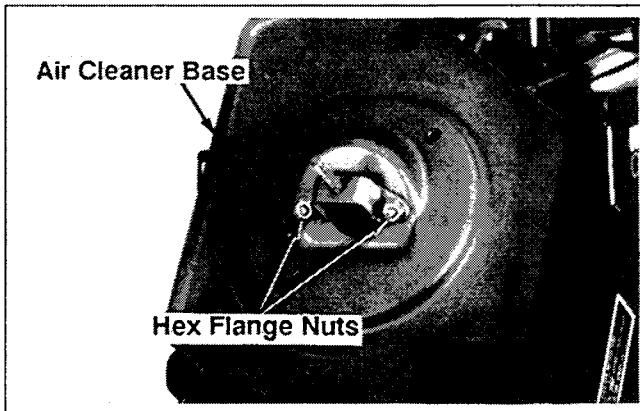

Figure 11-47. Installing Air Cleaner Base Plate.

3. Install the element and precleaner, element cover, washer, and wing nut. See figure 11-48.

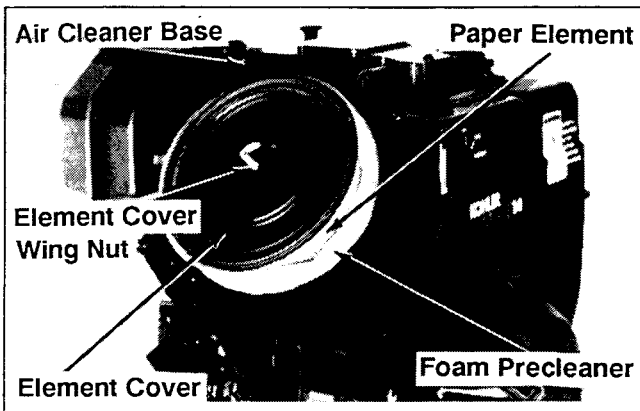

Figure 11-48. Installing Air Cleaner Elements.

4. Install the air cleaner cover and knob. See Figure 11-49.

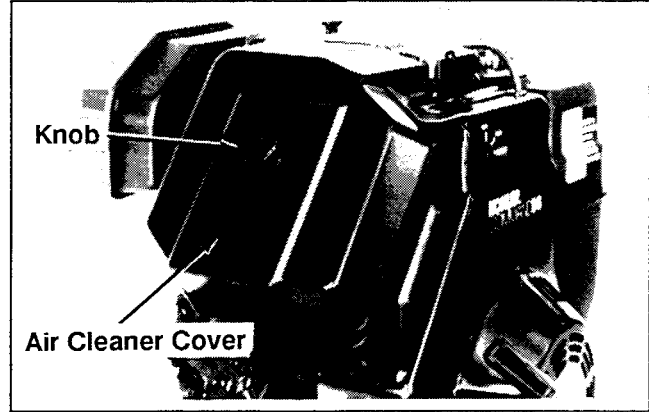

Figure 11-49. Installing Air Cleaner Cover.

INSTALL RETRACTABLE STARTER

1. Install the retractable starter and five hex flange screws to blower housing. Leave the screws slightly loose.
2. Pull the starter handle out until the pawls engage in the drive cup. Hold the handle in this position and tighten the screws securely. See Figure 11-50.

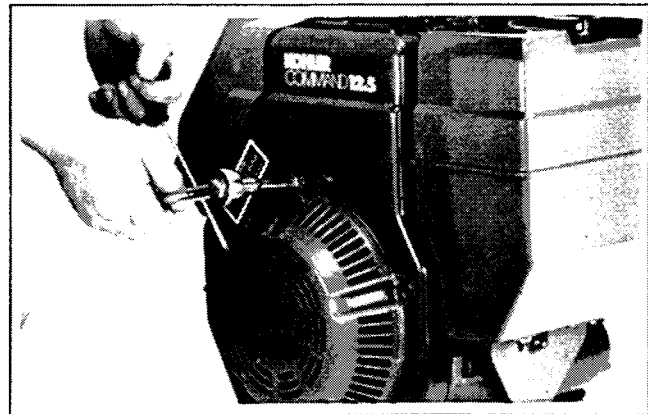

Figure 11-50. Installing Retractable Starter.

INSTALL MUFFLER

1. Install the gasket, muffler, and hex flange nuts to the exhaust port studs. Leave the nuts slightly loose. See Figure 11-51.
2. Secure the muffler to the muffler bracket using the two hex flange screws. See Figure 11-52.

3. Torque the hex flange nuts to 24.4 N·m (216 lbf·in), screws to 9.9 N·m (88 lbf·in).

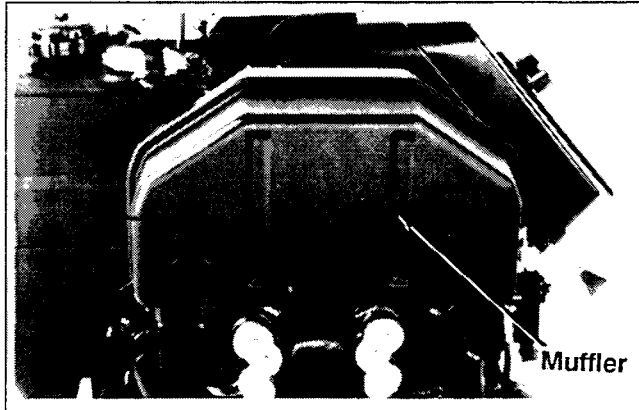

Figure 11-51. Installing Muffler.

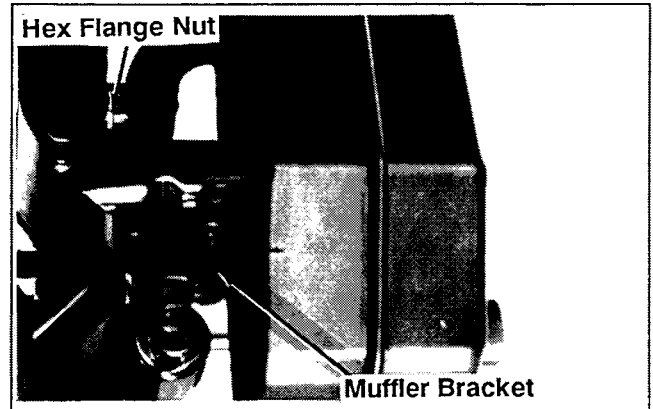

Figure 11-52. Installing Muffler.

FOR SALES AND SERVICE INFORMATION
IN U.S. AND CANADA, CALL
1-800-544-2444



KOHLERengines

ENGINE DIVISION, KOHLER CO., KOHLER, WISCONSIN 53044

FORM NO.:	TP-2402
ISSUED:	6/90
REVISED:	7/91
LITHO IN U.S.A.	