



8000-G SERIES TRACTOR OPERATORS MANUAL

NOTE

Read this manual carefully and learn to operate and service your tractor before using it.

To keep the warranty, the tractor must be maintained and operated as directed in this manual.

All references to "left-side", "right-side", "front", and "back" are given from the operator's position.

Use the serial numbers to ensure prompt and correct service when ordering parts, requesting service, or making inquiries.

TRACTOR SERIAL NUMBER 00582 345

ENGINE SERIAL NUMBER _____

ENGINE SPEC NUMBER _____



Look for this symbol to point out important safety precautions. It means -- ATTENTION! BECOME ALERT! YOUR SAFETY IS INVOLVED.

CONTENTS

1. INSTRUCTIONS FOR SAFE OPERATION
2. CONTROLS
3. OPERATING INSTRUCTIONS
4. SERVICE INSTRUCTIONS
5. STORAGE
6. PROBLEM SOLVING
7. SPECIFICATIONS AND WIRING
8. SET-UP INSTRUCTIONS
9. WARRANTY

SECTION 1

Instructions for Safe Operation

Improper use of this tractor can injure people and damage the equipment. People using or servicing this tractor must read and follow the instructions in this manual.

It is important to understand that this manual and any other Gravely instruction manuals do not cover every possible danger. It is impossible for Gravely to know of all possible dangers in operating and servicing the tractor and attachments.

The purchaser must give these instructions to the people operating and maintaining this tractor. These people must use eye and foot protection.

1.1 Preparation

1. Read the tractor and attachment operator's manuals carefully.
2. Learn the location and function of all tractor and attachment controls.
3. Learn how to use the controls to stop the tractor and attachment.
4. Use caution with gasoline. Gasoline is very flammable. Keep it in a clean and tight container away from flames or hot items. Never put gasoline in the fuel tank while the engine is running or hot. Clean up spilled gasoline before starting engine.
5. Be certain that all shields, guards, and interlock switches are in the correct positions.
6. When hauling the tractor, connect the chassis and rear hitch to the transporting vehicle. Never connect from control levers, rods, or like items that could be damaged.

1.2 Operation

1. Wear foot and eye protection. Do not wear loose clothing.
2. Do not use the tractor in the dark without adequate lighting.
3. Keep the tractor in good condition. Maintain it as directed in this manual.
4. Replace all parts that become damaged or lost.
5. USE ONLY GRAVELY ACCESSORIES AND ATTACHMENTS OR ATTACHMENTS GRAVELY HAS APPROVED FOR USE WITH THIS TRACTOR.
6. Do not overspeed the engine. Do not override the governor.
7. Keep away from moving parts.
8. Keep people and animals away from the operating area.
9. Do not let people other than the operator ride on the sulky.
10. Use a slow speed and engage the direction control lever slowly when operating on slopes.
11. Look for and keep away from hazards.
12. Before starting the engine, put the direction control lever in the "NEUTRAL" position and the PTO control in the "OFF" position.
13. Look behind when operating in reverse.
14. After hitting an object with the tractor or attachment, stop the engine and check for damage. Repair any damage before continuing operation.
15. Operate the tractor only from the operator's position, on the seat.
16. Travel up and down slopes.
17. Never permit children to operate the tractor.
18. Before leaving the tractor, move the PTO control to "OFF", lock the brake or put in gear and engage the direction control lever, and remove the ignition key.

19. If there is a sudden change in the sound or vibration of the tractor or attachments, stop the engine and check for damage. Repair any damage or failure before continuing operation.
20. Never run the engine indoors except to move it outside. Exhaust fumes are dangerous.
21. Go slow on slick surfaces.
22. Follow traffic laws when operating on or near a road.
23. Before making adjustments or servicing, move the PTO to "OFF", turn the ignition switch to "OFF", and wait until all moving parts completely stop.

SECTION 2

Controls

2.1 Figures 1 and 2 show the locations and identifications of the controls.

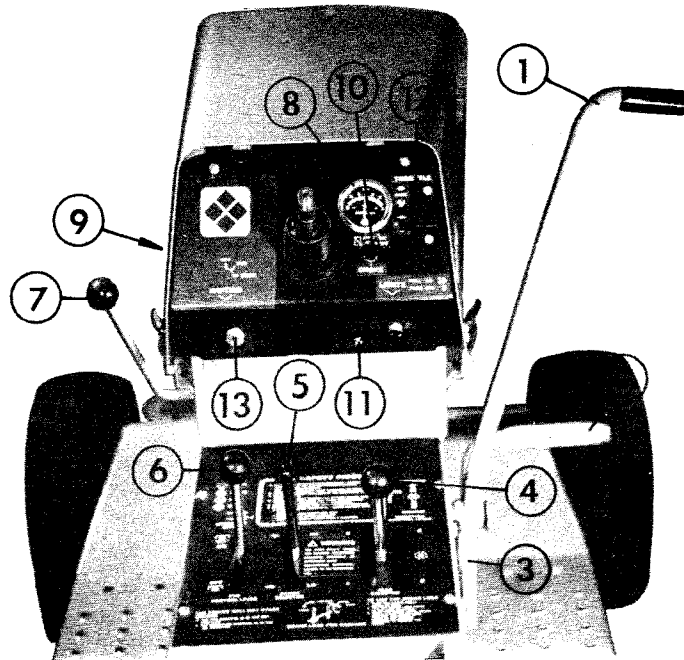

85042

- | | |
|-----------------------------|-----------------------|
| 1 - Direction Control Lever | 8 - Ammeter |
| 2 - Brake Pedal | 9 - Hourmeter |
| 3 - Brake Lock Lever | 10 - Choke Control |
| 4 - Gear Selector | 11 - Fuse Holder |
| 5 - Range Selector | 12 - Throttle Control |
| 6 - PTO Control | 13 - Ignition Switch |
| 7 - Hydraulic Lift Control | |

FIGURE 1

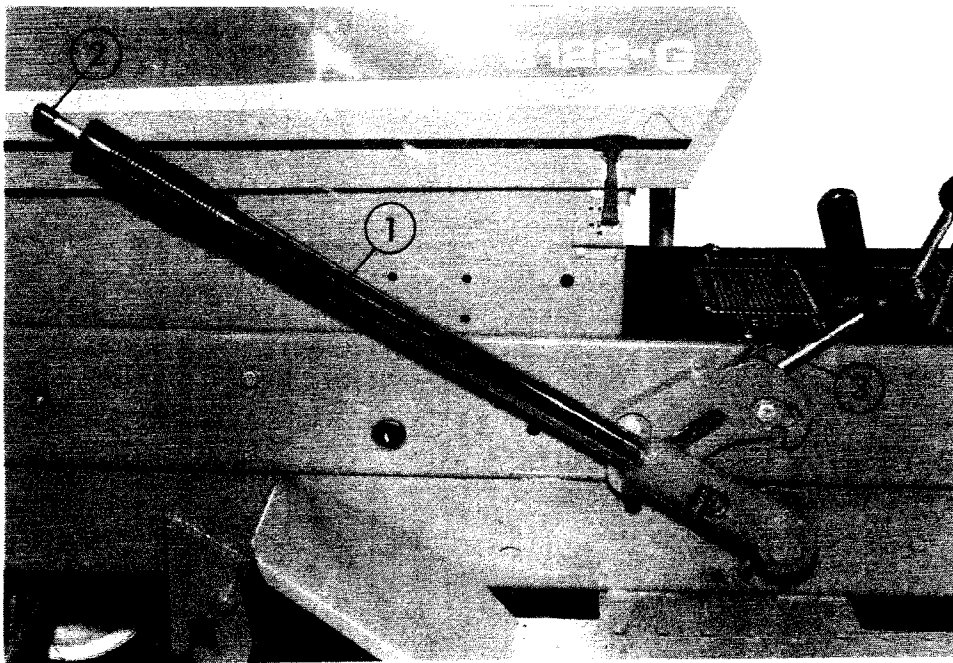

85043

- 1 - Manual Lift Lever
 - 2 - Release Button
 - 3 - Lift Range Control
- FIGURE 2

SECTION 3

Operating Instructions

Read this manual before operating the tractor. Read the Operator's Manual for any attachment that is to be used.

From the tractor seat, note the location of the tractor and attachment controls. (See Section 2.) ALWAYS BE IN THE SEAT WHEN OPERATING THE TRACTOR OTHER THAN IN STATIONARY APPLICATIONS.

3.1 Before Starting the Engine

Be sure that the tractor and engine has been properly serviced and maintained.

3.2 Starting and Stopping the Engine

To start the engine:

1. The direction control lever must be in "NEUTRAL" position and the PTO control must be at "OFF" position.
2. Put the key in the ignition switch.
3. Move the throttle lever to a middle position.
4. If the engine is cold, move the choke lever to "ON". If it is warm, the choke lever should be at "OFF".
5. Turn the ignition key to "START". When the engine starts, pull the choke lever slowly to "OFF". If the engine does not start in five seconds, release the key for a few seconds and then repeat. If the engine does not start within five tries, see Section 6 for instructions.

 **CAUTION:** Do not keep the starter running for over 15 seconds. Do not run the starter for more than 15 seconds in any one minute.

To stop the engine:

1. Move the throttle lever to "SLOW".
2. Turn the ignition switch to "OFF".
3. Remove the key before leaving the tractor.

3.3 Operating the Transmission

⚠ CAUTION: DO NOT SHIFT TRANSMISSION GEARS WHILE THE FORWARD OR REVERSE CLUTCHES ARE ENGAGED OR THE TRACTOR IS MOVING. This will damage the gears. Always place the direction control lever in "NEUTRAL" and bring the tractor to a complete stop before moving the gear or range selectors.

3.3.1 To Move in a Forward Direction

Use slow engine and transmission speeds until you know how to operate the tractor safely.

1. Start the engine and move the throttle to give the desired engine speed.
2. Put the range and gear selectors in the positions that will produce the desired speeds. See Section 7 for ground speeds produced.
3. Move the direction control lever forward. As the tractor increases speed, push the lever until it locks into position. If the lever is not pushed all the way forward, slippage can damage the forward clutch. USE CAUTION WHILE LEARNING TO OPERATE THE DIRECTION CONTROL LEVER.

NOTE: The operator must be in the seat to operate the direction control lever. If the operator leaves the seat with the direction control lever in the "FORWARD" position, the engine will stop.

3.3.2 To Move in a Reverse Direction

1. Follow Steps 1 through 3 under 3.3.1 above.
2. Pull the direction control lever firmly backward. The control lever does not lock into a reverse position. You must continue to pull back firmly to continue reverse travel. It will return to "NEUTRAL" upon release.

3.3.3 Stopping the Tractor

Pushing the brake pedal down will stop the tractor and return the direction control lever to "NEUTRAL". Use the brake pedal for sudden stops and for holding the tractor on slopes.

3.3.4 Locking the Brake

To lock the brake for parking, depress the brake pedal and pull back on the brake lock lever. To release, push on the pedal and move the lock lever forward.

3.3.5 Using the PTO

To power an attachment, push the PTO control forward to "ON". To stop an attachment, pull the PTO control rearward to "OFF". The operator must be in the tractor seat to operate the PTO. If the operator leaves the seat while the PTO control is in the "ON" position, the engine will stop.

3.3.6 Correct Operating Speeds

 **WARNING:** On rough and sloping ground and when mowing and trimming near buildings, trees, and other obstructions, use a slow ground speed.

NOTE: Most attachments, especially rotary mowers and snowblowers perform best when operated at full engine speed. Proper ground speed is determined by power limitations, the type of terrain, the quality requirements of the job being performed, obstructions, hazards, etc.

3.4 Using the Attachment Lift Systems

Manual or hydraulic lift systems are used to raise and lower attachments. Either can hold an attachment in position or let it follow the ground.

3.4.1 Using the Manual Lift System

To hold an attachment in position:

1. Lift the attachment to the raise position.
2. Lift the lift range control and slide it to the desired position.

3. Lower the attachment. The lift lever will stop against the lift range control. If the attachment is not in the desired position, repeat Steps 1 and 2.

To let an attachment follow the ground:

1. Move the lift range control to the lowest position.
2. Lower the attachment to the ground.

3.4.2 Using the Hydraulic Lift System

To hold an attachment in position:

1. Lift the attachment by pulling back on the hydraulic lift lever until the attachment is fully raised.
2. Lower the attachment to the desired position by gently pushing the lift lever forward.
3. When the attachment reaches the desired position, release the lever. The attachment will be held in that position.

To let an attachment follow the ground:

1. Push the hydraulic lift lever all the way forward to the "FLOAT" position. The attachment will be lowered to the ground and the lever will remain at that position until you pull it backwards.

3.5 Using the Tractor for Stationary Operations

To operate an attachment, such as a compost shredder that uses PTO power when the tractor is stationary:

1. Move the tractor attachment to the desired location. Put a weight in the seat.
2. Lock the brake and block wheels.
3. Put the gear selector in "NEUTRAL".
4. Move the PTO control to "ON".
5. Use caution when leaving the tractor seat. Keep away from moving parts.

SECTION 4

Service Instructions

Chart 1 shows the recommended schedule for service that should be performed on a regular basis.

SERVICE PERFORMED	TIME INTERVALS BETWEEN SERVICE		
	DAILY	25 HR.	200 HR
General Lubrication (Section 4.2)		X	
Check Engine Oil (Section 4.3)	X		
Check Battery Fluid (Section 4.5)			X
Check Battery (Section 4.5)			X
Check Air Intake Screen (Section 4.7)	X		
Check Cooling System (Section 4.8)		X	
Check Air Cleaner (Section 4.9)	X		
Check Transmission Oil (Section 4.11)		X	
Check Tire Pressure (Section 7)		X	

CHART 1

4.1 Filling the Fuel Tank

 **WARNING:** Gasoline is very flammable. Follow safety instructions shown in Section 1.

Gasoline is added as required. Use clean lead free or regular grade gasoline. To add gasoline:

1. Put the tractor in an open area.
2. Stop the engine and lock the brake.
3. Clean the fuel cap area.
4. Remove the fuel tank cap.
5. Fill the tank with gasoline. Use caution. Do not overflow.
6. Reinstall fuel tank cap.
7. If gasoline is spilled, wipe it up.

4.2 General Lubrication

There are seven grease fittings to be greased at 25-hour intervals. Clean the fittings before attaching the grease gun. Use a multi-purpose grease. Add grease until it appears at the ends of the bearings. The locations of the seven fittings are:

1. On the direction control lever.
2. On the front axle at each king pin.
3. On the front axle as shown in Figure 3.
4. On the steering mechanism as shown in Figure 4.

Apply motor oil to all pin connections, pivot points and areas where sliding occurs in the clutch, transmission, PTO, and lift control systems every 25 hours.

4.3 Checking the Engine Oil

Check the engine oil level daily. Never operate the engine with the oil level below the low mark on the dipstick. See your engine manual.

To check the oil level:

1. Clean around the dipstick to prevent dirt from entering the tube.
2. Remove the dipstick and wipe off the oil.
3. Put the dipstick back in place. Be sure it is all the way down.
4. Remove the dipstick again and note oil level.
5. Add oil, if needed. Do not overfill.
6. Repeat Step 3.

4.4 Changing the Engine Oil

1. Read your engine manual for recommended change schedule.
2. Move the tractor to a level area. Lock the brake.
3. If the engine is cold, let it run for 5 minutes.
4. When the engine is warm, stop it and raise the rear fender.

 **WARNING:** Engine muffler and other parts are hot.

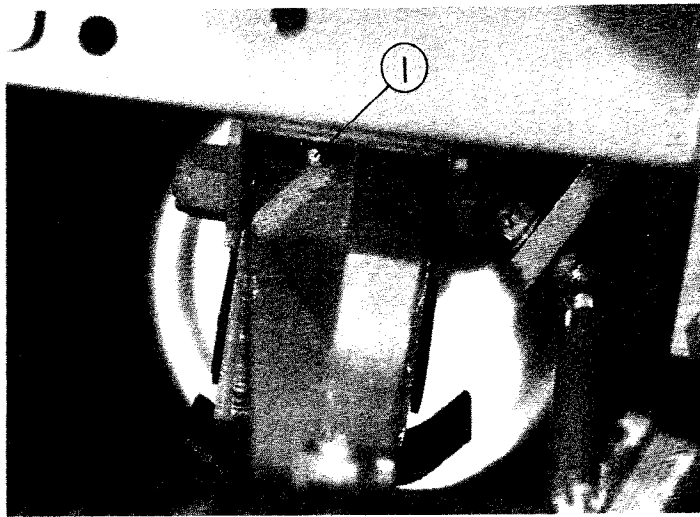

78211

1 - Grease Fitting on the Front Axle
FIGURE 3

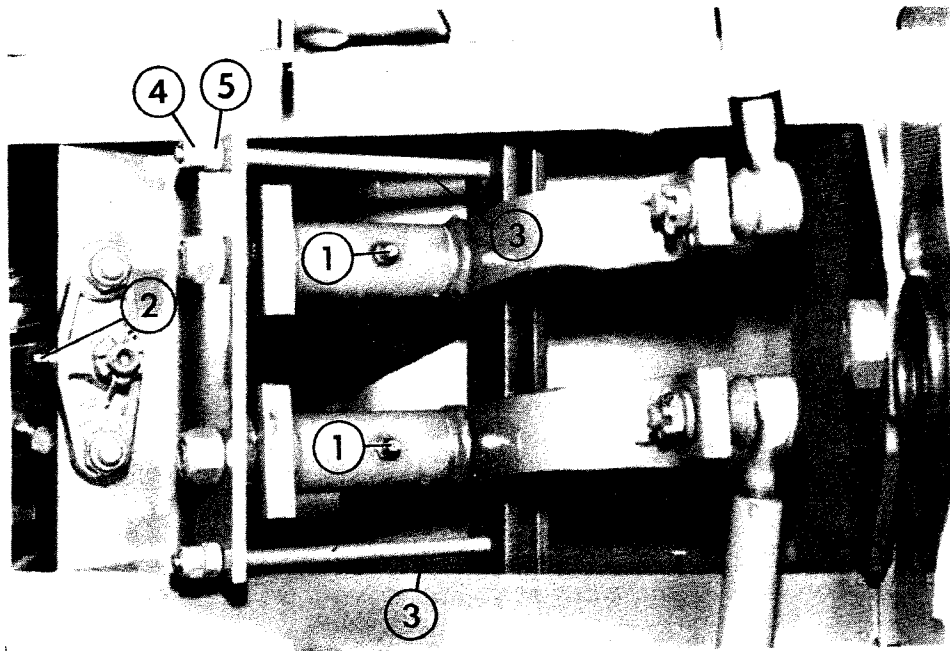

84081

1 - Grease Fittings for the Steering Arms
2 - Grease Fittings for the Steering Columns
3 - Adjusting Bolt
4 - Lock Nut
5 - Adjusting Nut

FIGURE 4

5. Clean the areas around the dipstick and drain plug.
6. Remove the dipstick.
7. Put an open top container that will hold four quarts under the drain plug.
8. Remove the drain plug.
9. Allow the engine to drain completely.
10. Clean and reinstall the drain plug.
11. Fill with new oil to the "FULL" mark on the dipstick.
12. Replace the dipstick. Lower the rear fender.
13. Start the engine and check for leakage at the drain plug. Tighten the plug if leakage occurs.

4.5 Checking the Battery Fluid

Check the battery fluid every 200 hours. Use caution and wear eye protection when checking the battery. To check the battery:

1. Clean the top of the battery.
2. Lift the filler caps.
3. If the fluid level is below the split rings in the filler tube, add distilled water. Do not fill above the split ring. Do not use a metal funnel.
4. Reinstall the filler caps. Push them all the way down.

4.6 Checking the Fasteners

Check all fasteners periodically. Look for loose or missing fasteners any time looseness of parts, rattles, or excess noise and vibration are noted. Make sure all bolts, screws, nuts, pins, snap rings, and cotter pins are in the correct position and replace any that are missing.

4.7 Checking the Air Intake Screen

Check the air intake screen on the engine each day. Remove any grass, dirt, or debris that may have accumulated on it. THE AIR INTAKE SCREEN MUST BE KEPT CLEAN.

4.8 Checking the Cooling System

Check the cooling system for signs of the collection of grass and debris in the engine cooling fins every 25 hours or more often when operated in dirty conditions. See your engine manual for instructions.

4.9 Checking the Air Cleaner

Check the air cleaner each day. See your engine manual for instructions.

4.10 Changing the Air Cleaner Element

Replace the air cleaner element at the correct intervals. See your engine manual for instructions.

4.11 Checking the Transmission Oil

Check the transmission oil level every 25 hours. If leakage is observed, check more frequently. The fill tube and check plug are shown in Figure 5. To check the transmission oil level:

1. Move the tractor to a level area. Stop the engine and lock the brake.
2. Raise the rear fender.
3. Clean the check plug and remove it.
4. The oil level is correct when oil is at the top of the hole.
5. If the level is correct, reinstall and tighten the plug. If the level is low, add oil. See Section 7 for recommended lubricant specifications.

To add oil:

1. Remove the fill tube cap.
2. Add oil until it reaches the top of the check plug hole.
3. Reinstall and tighten the fill tube cap and check plug.

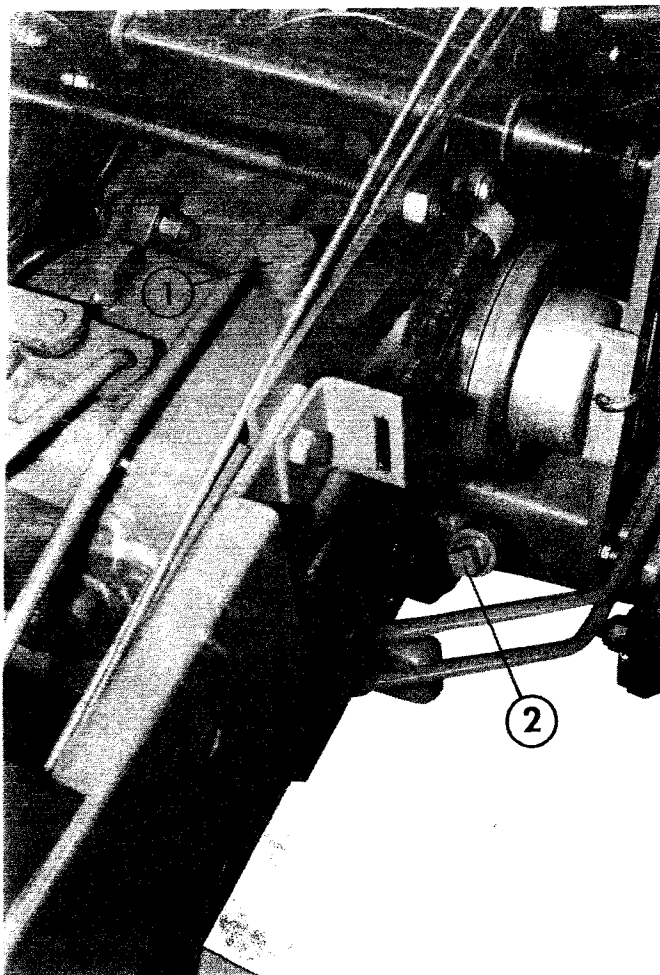

85044

- 1 - Fill Tube
 - 2 - Check Plug
- FIGURE 5

4.12 Servicing the Brake

Brake service is required if the brake does not stop and hold the tractor effectively. The brake should be effective enough to cause the rear wheels to slide if applied suddenly on a concrete or asphalt surface.

⚠ CAUTION: Replace the brake band when the lining is as thin as the ignition key.

Replace the brake drum if it is visibly worn or rough.

To adjust the brake:

1. Stop the tractor on a level surface.
2. Stop the engine and block the wheels so the tractor cannot roll.
3. Loosen the jam nut and remove the clevis pin.

4. Turn the clevis clockwise to tighten or counterclockwise to loosen as needed.
5. To check the adjustment, reconnect the clevis and brake band with the pin.
6. Push the direction control lever all the way forward.
7. Push the brake pedal by hand while watching the motion of the brake band. The brake is correctly adjusted when the band becomes tight on the drum as the direction control lever moves to "NEUTRAL". If the band is tight before the lever moves to "NEUTRAL", the brake is too tight. If too tight or too loose, repeat Steps 4, 5, 6, and 7 until the correct adjustment is obtained.
8. Install the cotter pin in the clevis pin and tighten the jam nut.
9. Check the effectiveness of the brake while operating the tractor.

4.13 Servicing the Forward and Reverse Clutches

The forward and reverse clutches must be checked every 100 hours. The forward clutch is on the right side of the transmission and the reverse clutch is on the left side of the transmission. See Figure 5.

Inspect and adjust the clutches as follows:

1. Stop the engine and place the direction control lever in the "NEUTRAL" position.
2. Raise the rear fender.
3. Measure the clearance in the slot. The correct clearance is .030 inch (.76mm) to .060 inch (1.5mm).
4. Adjust the bolts which go through the flange on the axle bearing retainer so that the forward-reverse clutch springs are straight up and down when the clutches have zero clearance. Lock the bolt in place with the jam nut. Loosen the jam nut which holds the slide rod bushing in place. Adjust the bushing on the slide rod until the clearance is correct. Lock the bushing in place with the jam nut.

To lubricate clutch, remove the clutch and apply a film of multi-purpose grease to the splined clutch shaft. Re-adjust as described above.

4.14 Servicing the PTO Clutch

The PTO clutch should be adjusted whenever there is less than .5 inches of free travel in the clutch lever when it is in the "ON" position. See Figure 6 to see where this free travel is measured. The free travel should be between .5 inch and 1.0 inch. To adjust:

1. Stop the engine and lock the brake.
2. Raise the rear fender.
3. Push the PTO lever to "ON".
4. Disconnect the PTO control from the transmission lever.
5. Turn the control rod to change the free travel. Each turn will change it by about .25 inch. Turn clockwise to increase and counterclockwise to decrease the free travel.
6. Reconnect the control rod to the transmission lever.
7. Check for correct free travel. Repeat Steps 4, 5, and 6 if necessary.

4.15 Servicing the Steering System

Adjustment is usually needed whenever there is more than 2 inches of free play in the steering wheels. To adjust the steering gear:

1. Loosen the lock nuts on both adjusting bolts. See Figure 4.

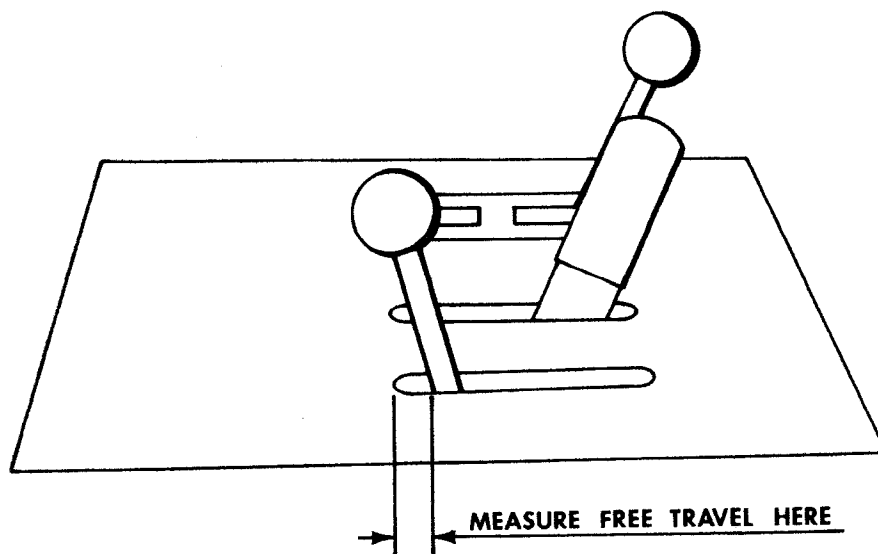

82107

FIGURE 6

2. Turn the steering wheel to the right as far as it will go.
3. Turn the adjusting nut on the left side adjusting bolt clockwise with your fingers until it is tight. Then back the nut off one fourth turn.
4. Tighten the lock nut against the adjusting nut being careful not to move the adjusting nut.
5. Turn the steering wheel to the left as far as it will go.
6. Repeat Steps 4 and 5 for the right side adjusting nut.
7. Check for tightness or backlash in the steering gear through the full range of the steering wheel rotation. There should be no noticeable tightness or backlash in the rack and pinion mesh. If there is, repeat Steps 3 through 7 as required.

Upon completion of the steering gear adjustment, recheck the steering wheel free play. If the free play is still excessive, look for loose steering arms on the king pins, loose or worn ball joints, or other signs of wear. Tighten or replace as required.

4.16 Servicing the Spark Plug(s)

To clean or change a spark plug:

1. Stop the engine, lock the brake, and raise the rear fender.
2. See your engine manual for further instructions.

4.17 Hydraulic Lift Service:

Check the hydraulic fluid level when:

1. The hydraulic lift will not raise the attachment.
2. Leaks are observed.

To check the hydraulic fluid level:

1. Put the hydraulic lift control in the "FLOAT" (full forward) position.
2. Clean the area around the filter/reservoir.

3. Remove the filter/reservoir. NOTE: When the filter is removed, some oil will run out because of the low pressure valve in the filter. Oil spillage will be minimized if the filter is removed after the tractor has not been operated for one-half hour.
4. The correct hydraulic fluid level is one inch from the top of the filter. Add Dextron II ATF to maintain this level.

The filter/reservoir should be replaced when:

1. The tractor has been used one year commercially.
2. The tractor has been used 2 years by a consumer.
3. The hydraulic system has been repaired.

To install a new filter/reservoir:

1. Fill a new filter to one inch from the top (observe the threaded hole).
2. Let the filter set for 15 minutes. Refill the filter to the correct level.
3. Install the filter.
4. If the hydraulic system has been repaired or leaks fluid:
 - a. Operate the lift.
 - b. Shut off the tractor.
 - c. Put the hydraulic lift control in the "FLOAT" position.
 - d. Remove the filter/reservoir and fill to one inch below the top.
 - e. Replace the filter/reservoir.

SECTION 5

Storage

5.1 When the tractor will not be operated for more than two months:

1. Do the daily and 25-hour maintenance, but do not add gasoline.
2. Clean the tractor. Paint or oil bare metal surfaces to prevent rust.
3. Refer to the engine manual and prepare the engine for storage.
4. Clean and charge the battery. Charge the battery every three or four weeks while in storage.
5. Place the P.T.O. lever in "OUT" position.
6. Store in a cool, dry place.

5.2 To use the tractor again:

1. Refer to the engine manual and prepare the engine for service.
2. Charge the battery.
3. Put fresh, clean gasoline in the fuel tank.

SECTION 6

Problem Solving

OBSERVATION	POSSIBLE CAUSE
1. No sound or motion when the ignition switch is turned to the "START" position.	PTO control in the "ON" position Direction Control Lever in the forward or reverse position Blown fuse Discharged battery Starting solenoid damaged Loose battery cable(s) Damaged time delay module
2. When the ignition switch is turned to "START", the solenoid "clicks" and the engine starter motor does not operate.	Discharged battery Battery cable connector(s) corroded Starter damaged
3. When the ignition switch is turned to "START", the starter operates but the engine does not start.	Relay or relay connection(s) Fuel tank empty Fuel valve turned off Loose wire to + side of engine coil Engine spark plug(s) fouled Engine failure -- see Engine Service Manual
4. Battery discharged	Regulator-rectifier failure Poor connection(s) to the ignition switch regulator-rectifier Fuse holder or battery Engine alternator failure Battery failure
5. Engine continues to run when the ignition switch is rotated to the "OFF" position.	Ground wire not connected (8163-G) Ignition switch failure
6. Lights do not come on when the light switch is moved to the "ON" position.	Light(s) burned out Defective light switch Loose wire connections Engine light alternator failure (8163-G) Ignition switch failure
7. Engine runs rough or stops after it gets hot.	See Engine Service Manual Time delay failure

OBSERVATION	POSSIBLE CAUSE
8. Fuse blows when starting engine.	Defective solenoid B+ to engine coil grounded
9. Hydraulic lift will not lift attachment.	Hydraulic valve seals Cylinder seals Low fluid level Hydraulic pump

7.1 Grounds Speeds (at 3600 rpm Engine Speed)

FORWARD

<u>"LO" RANGE</u>		<u>"HI" RANGE</u>	
<u>Gear</u>	<u>Speed</u>	<u>Gear</u>	<u>Speed</u>
1	.5 mph (.8 km/h)	1	2.5 mph (4.0 km/h)
2	.8 mph (1.2 km/h)	2	3.8 mph (6.1 km/h)
3	1.1 mph (1.8 km/h)	3	5.7 mph (9.2 km/h)
4	1.7 mph (2.7 km/h)	4	8.5 mph (13.7 km/h)

REVERSE

"HI" OR "LO" RANGES

<u>Gear</u>	<u>Speed</u>
1	1.1 mph (1.8 km/h)
2	1.7 mph (2.7 km/h)
3	2.5 mph (4.0 km/h)
4	3.8 mph (6.1 km/h)

7.2 Wiring Diagrams

1. 8122-G and 8123-G tractors

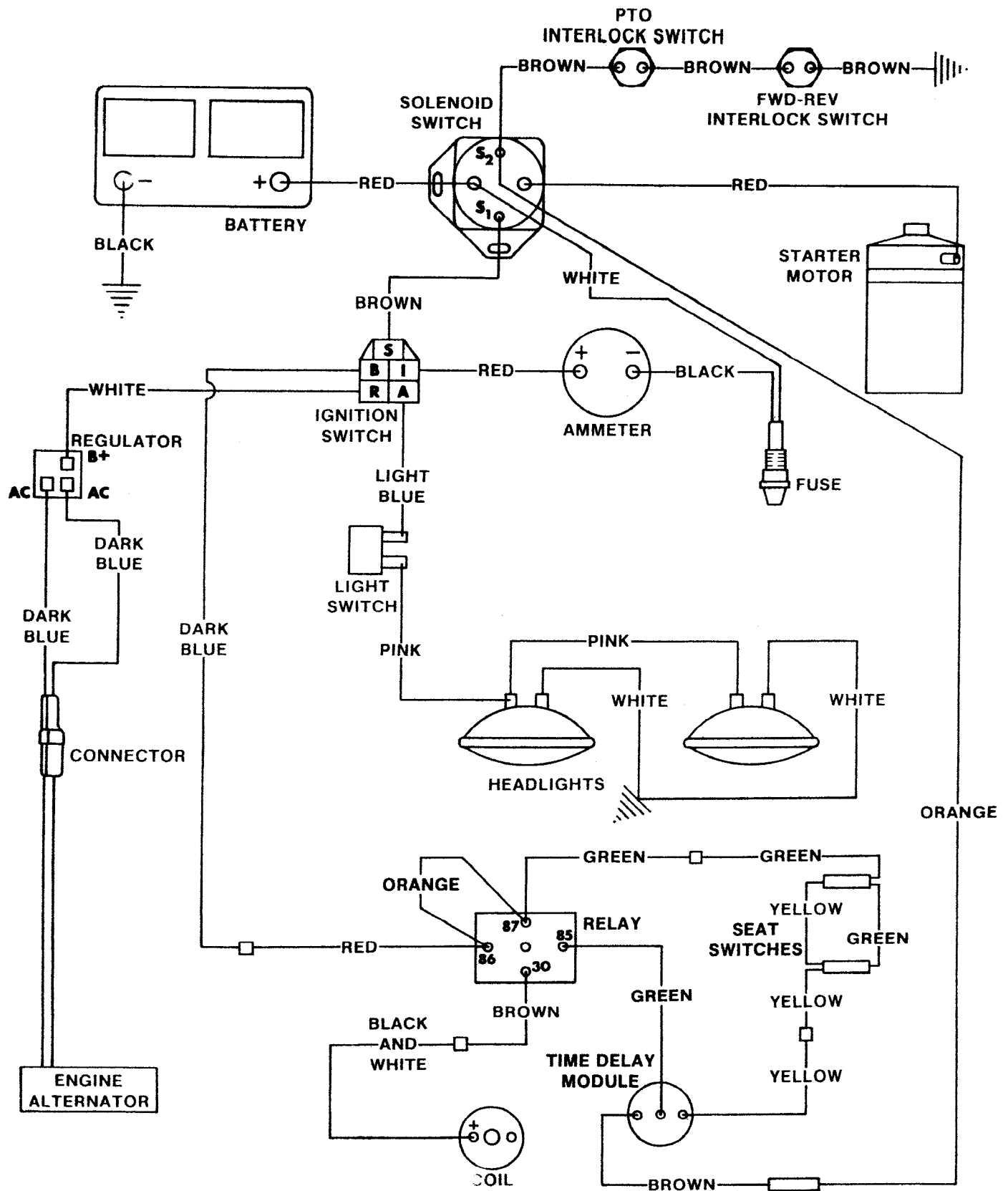

2. 8163-G tractors

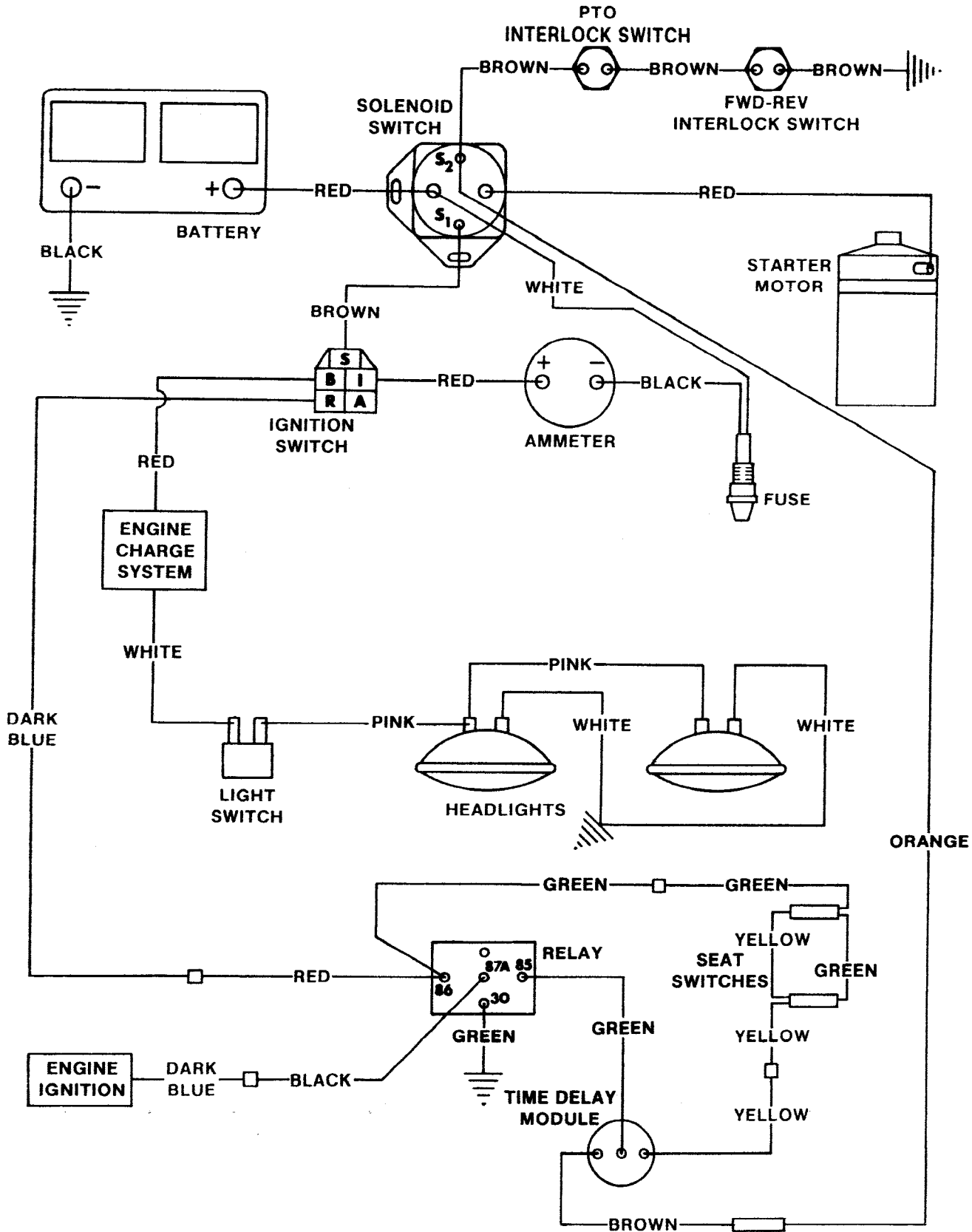

3. 8179-G and 8199-G tractors

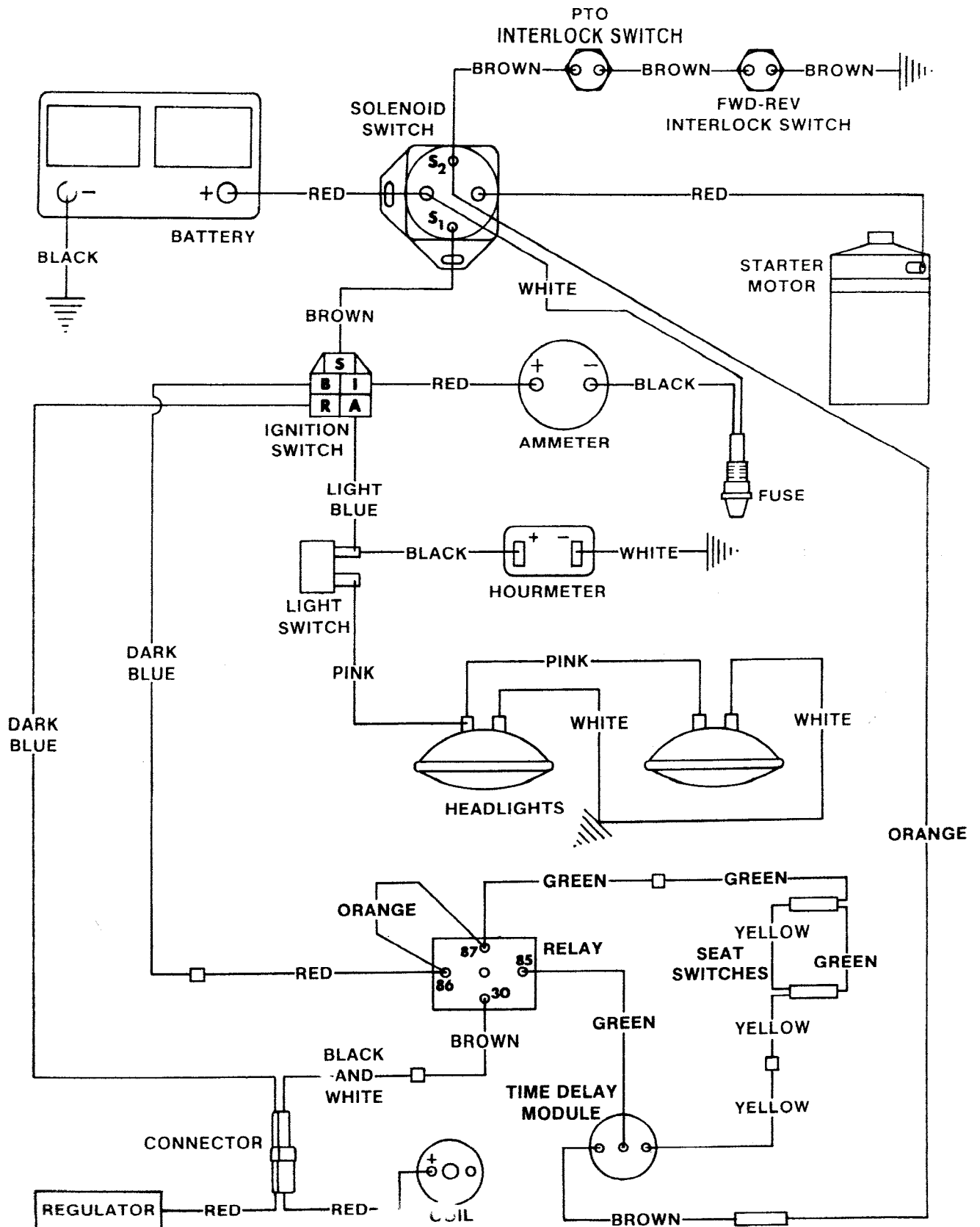

SECTION 8

Set-Up Instructions

8.1 Remove the tractor from the shipping container.

8.2 Rear Tire Assembly Installation:

1. Raise the rear of the tractor.
2. Mount the rear wheel assemblies to the wheel hub with 7/16-20x3/4 hub bolts. NOTE: The valve stem must be turned toward the inside of the twin cylinder engine tractors.
3. Lower the tractor.
4. Adjust the air pressure in the rear tires to 10 psi (69 kN/m²) to 14 psi (97 kN/m²).

8.3 Front Tire Assembly Installation:

1. Raise the front of the tractor.
2. Put two .813x1.375x1.00 flat washers on each front axle. See Figure 7.
3. Slide a spacer into the grease seal on the valve stem side of each front wheel.
4. Put multi-purpose grease on each axle.
5. Put a wheel, the valve stem towards the inside, on each axle.
6. Pack multi-purpose grease into each bearing. Make sure the bearing cages are full of grease.
7. Slide a bearing, tapered end first, onto each axle. Push the bearings into the wheels.
8. Put a spacer and then a .565x1.312x.095 flat washer on each axle. Fasten them with the 5/8" lock nuts.
9. Tighten the lock nuts slowly to take up the clearance in the bearings.

NOTE: The front wheels must turn freely with no clearance in the bearings.

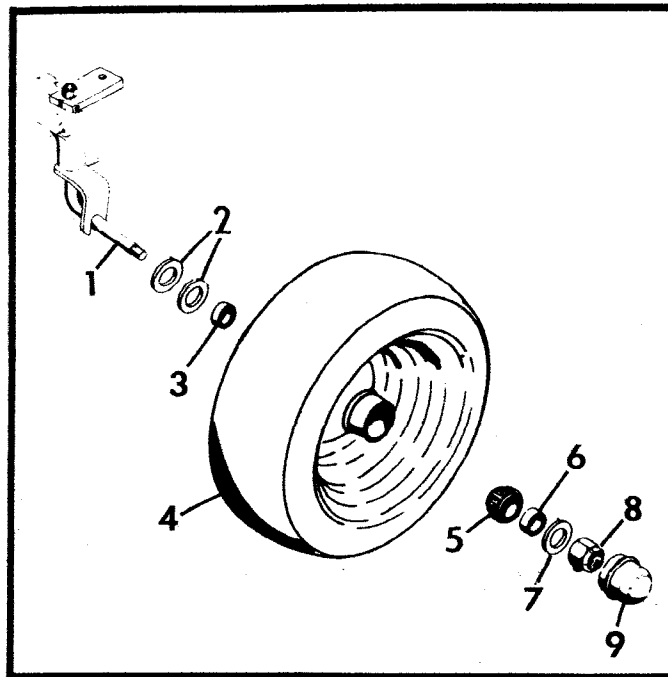

81305

- | | |
|------------------------------|------------------------------|
| 1 - Axle | 6 - Spacer |
| 2 - Flat Washer (.813" I.D.) | 7 - Flat Washer (.656" I.D.) |
| 3 - Spacer | 8 - Lock Nut |
| 4 - Wheel | 9 - Dust Cap |
| 5 - Bearing | |

FIGURE 7

10. Install the dust cap.
11. Lower the front of the tractor
12. Adjust the air pressure₂ in the front tires to 14 psi (97 kN/m²) to 18 psi (124 kN/m²).

8.4 To Connect the Direction Control Lever:

1. Align the hole in the lower end of the direction control lever with the hole in the shifter link and neutral return strap.
2. Put a clevis pin through the holes from the outside.
3. Secure with a flat washer and cotter pin.

8.5 Steering Wheel Installation:

1. Put the steering wheel bushing on the steering wheel shaft. Make sure the steering wheel bushing fits over the nylon bushing in the instrument panel. See Figure 8.
2. Put the nylon bushing on the steering wheel shaft and into the steering wheel bushing.
3. Put the spring on the steering wheel shaft.

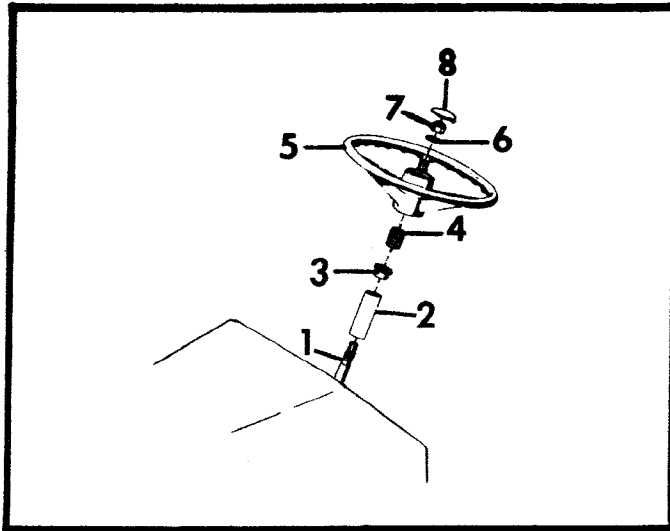

- | | |
|----------------------------|---------------------------|
| 1 - Steering Wheel Shaft | 5 - Steering Wheel |
| 2 - Steering Wheel Bushing | 6 - Flat Washer |
| 3 - Nylon Bushing | 7 - Lock Nut |
| 4 - Spring | 8 - Steering Wheel Insert |

FIGURE 8

4. Put the steering wheel on the steering wheel shaft.
5. Put a .656x1.312x.095 flat washer on the steering wheel shaft. Install the 5/8" lock nut. Tighten the nut to a torque of 20 ft. lbs. (27 N.m).
6. Install the steering wheel insert.

8.6 Seat Installation:

1. Tighten the 5/16 hex bolts and lock washer holding the seat to the seat springs. See Figure 9.
2. Align the holes in the seat springs with the holes in the seat pan.
3. Fasten the seat in position on the seat pan with the 5/16x3/4 round head bolts, flat washer, and lock nuts.
4. Plug in seat switch.

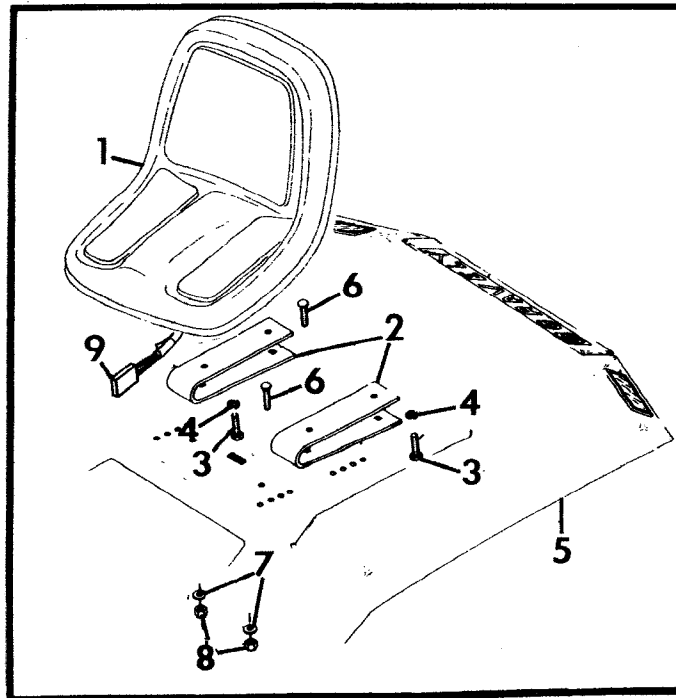

- | | |
|------------------|----------------------|
| 1 - Seat | 6 - Round Head Bolts |
| 2 - Seat Springs | 7 - Flat Washer |
| 3 - Hex Bolts | 8 - Lock Nuts |
| 4 - Lock Washers | 9 - Plug |
| 5 - Seat Pan | |

FIGURE 9

LIMITED FIVE-YEAR WARRANTY

This Limited Five-Year Warranty is issued by Gravely International, Inc., only to the original purchaser. If Gravely equipment is leased by Gravely, this Warranty shall extend also to the original lessee as if such lessee were the original purchaser.

Gravely warrants that all new equipment manufactured by Gravely ("Gravely Products") shall be free of defects in material and workmanship for the term described in Paragraph 4, below. Except as hereinafter provided, this Warranty does not cover any engine, tires or battery forming a part of the Gravely Product. Engine and tires are covered by and subject to separate warranties of the manufacturers thereof.

In the event that any Gravely Product warranted hereunder shall be defective or fail to conform with this Warranty, Gravely shall, subject to the provisions hereof, pay for, or provide labor and materials for, the repair or replacement of such defective Gravely Product.

This Warranty is for five years (60 months) from purchase date for Gravely Products used exclusively for personal, family or household purposes, and two years (24 months) for products used for other purposes (commercial use). Repair of Gravely Products after the second year (24 months from date of purchase) shall be subject to a \$50.00 deductible for each repair. (After two years, Gravely agrees to repair or replace defective Gravely Products used exclusively for personal, family or household purposes only to the extent that the cost of such repair or replacement exceeds \$50.00.)

Batteries are warranted by Gravely for a period of twelve (12) months only. If a battery shall fail within twelve (12) months of purchase, the replacement cost thereof shall be prorated over a twelve-month term based upon the number of months since purchase.

To obtain Warranty Service on a Gravely Product including any battery or other component not manufactured by Gravely, use this procedure:

- a. Notify the Gravely dealer from whom you purchased the equipment.
- b. If you have moved and it is not convenient to notify the selling dealer, notify the nearest Gravely dealer. You should supply this dealer with a copy of the bill of sale as proof of the date of purchase.
- c. Make arrangements to have the equipment delivered to the dealer (refer to paragraph 6 a., below).
- d. If you have any questions concerning the Gravely Limited Warranty, they should be referred to:

Gravely International, Inc.
One Gravely Lane
Clemmons, NC 27012
Attn: Customer Service Department

- e. Warranty service on Gravely Products must be performed by an authorized Gravely dealer.

6. This Warranty does not cover the following:
 - a. Transportation to the Gravely dealership. (If the Gravely dealer provides transportation, he will charge for such service.)
 - b. Normal maintenance services and normal replacement of items such as spark plugs, belts, oil, oil filters, air filters, and mower, plow or cultivator blades, gauge wheels, skids and other wear items.
 - c. Any Gravely Product which has been altered or modified in any way.
 - d. Any repair or replacement occasioned by customer neglect or lack of proper maintenance. (The purchaser is responsible for making sure that Gravely Products are operated and serviced as directed in the applicable manual or service instruction. Incorrect use or maintenance will void this Warranty.)
 - e. Any repair occasioned by the use of any attachment not approved by Gravely. (The use of any such unapproved attachment will void this Warranty.)
7. GRAVELY MAKES NO OTHER EXPRESS OR IMPLIED WARRANTIES, OR WARRANTIES AS TO THE MERCHANTABILITY OR FITNESS FOR A PARTICULAR PURPOSE. ALL WARRANTIES ARE LIMITED IN DURATION TO THE TERMS SET OUT IN PARAGRAPH 4, ABOVE. GRAVELY SHALL HAVE NO LIABILITY FOR INCIDENTAL OR CONSEQUENTIAL DAMAGES RESULTING FROM THE BREACH OF ANY WARRANTY, INCLUDING, BUT NOT LIMITED TO, LIABILITY FOR INCONVENIENCE, RENTAL OR PURCHASE OF REPLACEMENT EQUIPMENT, OR FOR LOSS OF PROFITS OR OTHER COMMERCIAL LOSS.
8. Some states do not allow limitations on how long an implied warranty lasts, so the above statement may not apply to you. Some states do not allow the exclusion or limitation of incidental or consequential damages, so the above limitation or exclusion may not apply to you.
9. This Warranty gives you specific legal rights, and you may have other rights which vary from state to state.
10. A Gravely product registration card is supplied with each Gravely Product. Please complete the card and return it to Gravely at the address listed on the card. The equipment registration card will be used by Gravely for:
 - a. Recording date of purchase.
 - b. Notification of owners in compliance with the Consumer Product Safety Act, should any notification be necessary.
11. The return of such card is necessary for your warranty to be effective.
11. This Warranty is not subject to change or modification by anyone, including Gravely dealers and no Gravely dealer is authorized to make any representations or promises on Gravely's behalf.



One Gravely Lane, Clemmons, NC 27012